



NCEA-S-0619  
External Review Draft

DRAFT  
DO NOT CITE OR QUOTE

# **TOXICOLOGICAL REVIEW**

**of**

# **VINYL CHLORIDE**

(CAS No. 75-01-4)

**In Support of Summary Information on the  
Integrated Risk Information System (IRIS)**

May 1999

## **NOTICE**

This document is an expert panel peer review draft. It has not been formally released by the U.S. Environmental Protection Agency and should not at this stage be construed to represent Agency position on this chemical. It is being circulated for peer review on its technical accuracy and policy implications.

U.S. Environmental Protection Agency  
Washington, DC

## **DISCLAIMER**

This document is an external review draft for review purposes only and does not constitute U.S. Environmental Protection Agency policy. Mention of trade names or commercial products does not constitute endorsement or recommendation for use.

**CONTENTS—TOXICOLOGICAL REVIEW FOR VINYL CHLORIDE**  
**(CAS No. 75-01-4)**

FOREWORD .....	v
AUTHORS, CONTRIBUTORS, AND REVIEWERS .....	vi
1. INTRODUCTION .....	1
2. CHEMICAL AND PHYSICAL INFORMATION RELEVANT TO ASSESSMENTS .....	2
3. TOXICOKINETICS/TOXICODYNAMICS RELEVANT TO ASSESSMENTS .....	2
4. HAZARD IDENTIFICATION .....	6
4.1. STUDIES IN HUMANS—EPIDEMIOLOGY, CASE REPORTS, CLINICAL CONTROLS .....	6
4.1.1. Cancer Effects .....	6
4.1.2. Noncancer Effects .....	11
4.2. PRECHRONIC AND CHRONIC STUDIES AND CANCER BIOASSAYS IN ANIMALS—ORAL AND INHALATION .....	13
4.3. REPRODUCTIVE/DEVELOPMENTAL STUDIES—ORAL AND INHALATION .....	19
4.4. OTHER STUDIES .....	22
4.4.1. Neurological .....	22
4.4.2. Genotoxicity .....	22
4.4.3. Noncancer Mechanism .....	24
4.5. SYNTHESIS AND EVALUATION OF MAJOR NONCANCER EFFECTS AND MODE OF ACTION .....	25
4.6. WEIGHT-OF-EVIDENCE EVALUATION AND CANCER CHARACTERIZATION .....	26
4.7. SUSCEPTIBLE POPULATIONS .....	27
4.7.1. Possible Childhood Susceptibility .....	27
4.7.2. Possible Gender Differences .....	33
5. DOSE-RESPONSE ASSESSMENTS .....	33
5.1. ORAL REFERENCE DOSE (RfD) .....	33
5.1.1. Choice of Principal Study and Critical Effect .....	33
5.1.2. Methods of Analysis—Including Models (PBPK, BMD, etc.) .....	34
5.1.3. RfD Derivation .....	37
5.2. INHALATION REFERENCE CONCENTRATION (RfC) .....	38
5.2.1. Choice of Principal Study and Critical Effect .....	38
5.2.2. Methods of Analysis—Including Models (PBPK, BMC, etc.) .....	39
5.3. CANCER ASSESSMENT .....	41
5.3.1. Choice of Study/Data With Rationale and Justification .....	41
5.3.2. Dose-Response Data .....	44
5.3.3. Dose Conversion .....	45
5.3.4. Extrapolation Method(s) .....	46

## CONTENTS (continued)

5.3.5. Oral Slope Factor and Inhalation Unit Risk .....	47
6. MAJOR CONCLUSIONS IN CHARACTERIZATION OF HAZARD AND DOSE RESPONSE .....	54
6.1. HUMAN HAZARD POTENTIAL .....	54
6.1.1. Hazard Identification for Cancer Effects .....	54
6.1.2. Hazard Identification for Noncancer Effects .....	54
6.2. DOSE RESPONSE .....	55
6.2.1. Dose Response for Cancer Effects .....	55
6.2.2. Dose Response for Noncancer Effects .....	57
7. REFERENCES .....	61
APPENDIX A. Comparison of PBPK Models for Vinyl Chloride .....	A-1
APPENDIX B. The Development and Validation of a PBPK Model for Vinyl Chloride (VC) and its Application in a Carcinogenic Risk Assessment .....	B-1
APPENDIX C. Vinyl Chloride PBPK Model Code (ACSL Version: VCPBPK.CSL) .....	C-1
APPENDIX D. The Application of a PBPK Model for Vinyl Chloride in a Noncancer Risk Assessment .....	D-1
APPENDIX E. External Peer Review—Summary of Comments and Disposition .....	E-1

## **FOREWORD**

The purpose of this Toxicological Review is to provide scientific support and rationale for the hazard and dose-response assessment in IRIS pertaining to chronic exposure to vinyl chloride. It is not intended to be a comprehensive treatise on the chemical or toxicological nature of vinyl chloride.

In Section 6, EPA has characterized its overall confidence in the quantitative and qualitative aspects of hazard and dose response. Matters considered in this characterization include knowledge gaps, uncertainties, quality of data, and scientific controversies. This characterization is presented in an effort to make apparent the limitations of the assessment and to aid and guide the risk assessor in the ensuing steps of the risk assessment process.

For other general information about this assessment or other questions relating to IRIS, the reader is referred to EPA's Risk Information Hotline at 513-569-7254.

## **AUTHORS, CONTRIBUTORS, AND REVIEWERS**

### **Chemical Manager/Author**

William E. Pepelko, Ph.D.  
National Center for Environmental Assessment  
Office of Research and Development  
U.S. Environmental Protection Agency  
Washington, DC

### **Co-Author**

Gary L. Foureman, Ph.D.  
National Center for Environmental Assessment  
Office of Research and Development  
U.S. Environmental Protection Agency  
Washington, DC

### **Additional Contributors**

Vincent J. (Jim) Cogliano, Ph.D.  
National Center for Environmental Assessment  
Office of Research and Development  
U.S. Environmental Protection Agency  
Washington, DC

### **Reviewers**

This document and summary information on IRIS have received peer review both by EPA scientists and by independent scientists external to EPA. Subsequent to external review and incorporation of comments, this assessment has undergone an Agencywide review process whereby the IRIS Program Manager has achieved a consensus approval among the Office of Air and Radiation; Office of Policy, Planning and Evaluation; Office of Prevention, Pesticides, and Toxic Substances; Office of Research and Development; Office of Solid Waste and Emergency Response; Office of Water; and the Regional Offices.

### **Internal EPA Reviewers**

Robert Beliles, Ph.D.  
National Center for Environmental Assessment  
Office of Research and Development  
U.S. Environmental Protection Agency  
Washington, DC

## **AUTHORS, CONTRIBUTORS, AND REVIEWERS (continued)**

Jerry Blancato, Ph.D.  
National Environmental Research Laboratory  
Office of Research and Development  
U.S. Environmental Protection Agency  
Washington, DC

Vanessa Vu, Ph.D.  
Office of Pollution Prevention and Toxics  
U.S. Environmental Protection Agency  
Washington, DC

### **External Peer Reviewers**

James J. Beaumont, Ph.D.  
University of California  
Davis, CA

Michael L. Dourson, Ph.D.  
Toxicology Excellence for Risk Assessment  
Cincinnati, OH

Patrick R. Durkin, Ph.D.  
Syracuse Environmental Research Associates, Inc.  
Fayetteville, NY

Michael L. Gargas, Ph.D., DABT  
Chem Risk  
Cleveland, OH

Dawn G. Goodman, V.M.D.  
Private Consultant  
Potomac, MD

Bryan D. Hardin, Ph.D.  
National Institute for Occupational Safety and Health  
Washington, DC

Norbert P. Page, Ph.D.  
Page Associates  
Gaithersburg, MD

Colin Park, Ph.D.  
The Dow Chemical Company  
Midland, MI

**AUTHORS, CONTRIBUTORS, AND REVIEWERS (continued)**

Portier Chris, Ph.D  
NIEHS  
Res Triangle Park, NC

Richard H. Reitz, Ph.D., DABT  
RHR Toxicology Consulting  
Midland, MI

Carlo H. Tamburro, M.D., M.P.H.  
University of Louisville  
Louisville, KY

Sharon B. Wilbur  
Agency for Toxic Substances and Disease Registry  
U.S. Department of Health and Human Services  
Atlanta, GA



## 1. INTRODUCTION

This document presents background and justification for the hazard and dose-response assessment summaries in EPA's Integrated Risk Information System (IRIS). IRIS summaries may include an oral reference dose (RfD), inhalation reference concentration (RfC) and a carcinogenicity assessment.

The RfD and RfC provide quantitative information for noncancer dose-response assessments. The RfD is based on the assumption that thresholds exist for certain toxic effects such as cellular necrosis but may not exist for other toxic effects such as some carcinogenic responses. It is expressed in units of mg/kg-day. In general, the RfD is an estimate (with uncertainty spanning perhaps an order of magnitude) of a daily exposure to the human population (including sensitive subgroups) that is likely to be without an appreciable risk of deleterious noncancer effects during a lifetime. The inhalation RfC is analogous to the oral RfD, but provides a continuous inhalation exposure estimate. The inhalation RfC considers toxic effects for both the respiratory system (portal-of-entry) and for effects peripheral to the respiratory system (extrarespiratory or systemic effects). It is generally expressed in units of mg/m<sup>3</sup>.

The carcinogenicity assessment provides information on the carcinogenic hazard potential of the substance in question and quantitative estimates of risk from oral exposure and inhalation exposure. The information includes a weight-of-evidence judgment of the likelihood that the agent is a human carcinogen and the conditions under which the carcinogenic effects may be expressed. Quantitative risk estimates are presented in three ways. The *slope factor* is the result of application of a low-dose extrapolation procedure and is presented as the risk per mg/kg/day. The *unit risk* is the quantitative estimate in terms of either risk per  $\mu\text{g/L}$  drinking water or risk per  $\mu\text{g/m}^3$  air breathed. Another form in which risk is presented is a drinking water or air concentration providing cancer risks of 1 in 10,000; 1 in 100,000; or 1 in 1,000,000.

Development of these hazard identification and dose-response assessments for vinyl chloride has followed the general guidelines for risk assessment as set forth by the National Research Council (1983). EPA guidelines that were used in the development of this assessment may include the following: the *Guidelines for Carcinogen Risk Assessment* (U.S. EPA, 1986a), *Guidelines for the Health Risk Assessment of Chemical Mixtures* (U.S. EPA, 1986b), *Guidelines for Mutagenicity Risk Assessment* (U.S. EPA, 1986c), *Guidelines for Developmental Toxicity Risk Assessment* (U.S. EPA, 1991), *Proposed Guidelines for Neurotoxicity Risk Assessment* (U.S. EPA, 1995a), *Guidelines for Neurotoxicity Risk Assessment* (U.S. EPA, 1998b), *Proposed Guidelines for Carcinogen Risk Assessment* (1996a), and *Reproductive Toxicity Risk Assessment Guidelines* (U.S. EPA, 1996b); *Recommendations for and Documentation of Biological Values for Use in Risk Assessment* (U.S. EPA, 1988); (proposed) *Interim Policy for Particle Size and Limit Concentration Issues in Inhalation Toxicity* (U.S. EPA, 1994a); *Methods for Derivation of Inhalation Reference Concentrations and Application of Inhalation Dosimetry* (U.S. EPA, 1994b); *Peer Review and Peer Involvement at the U.S. Environmental Protection Agency* (U.S. EPA, 1994c); *Use of the Benchmark Dose Approach in Health Risk Assessment* (U.S. EPA, 1995b); *Science Policy Council Handbook: Peer Review* (U.S. EPA, 1998a); and memorandum from EPA Administrator, Carol Browner, dated March 21, 1995, Subject: Guidance on Risk Characterization.

Literature search strategy employed for this compound were based on the CASRN and at least one common name. At a minimum, the following databases were searched: RTECS, HSDB, TSCATS, CCRIS, GENETOX, EMIC, EMICBACK, DART, ETICBACK, TOXLINE, CANCERLINE, MEDLINE, and MEDLINE backfiles. Any pertinent scientific information submitted by the public to the IRIS Submission Desk was also considered in the development of this document.

## 2. CHEMICAL AND PHYSICAL INFORMATION RELEVANT TO ASSESSMENTS

Common synonyms of vinyl chloride (VC) include chloroethene, chloroethylene, ethylene monochloride, and monochloroethene. Some relevant physical and chemical properties of VC are listed below (Sax and Lewis, 1989):

CASRN: 75-01-4

Empirical formula:  $C_2H_3Cl$

Structural formula:  $CH_2 = CHCl$

Molecular weight: 62.5

Vapor pressure: 2,660 mm Hg at 25°C

Water solubility: 2,763 mg/L (U.S. EPA, 1985); 1,100 mg/L (Cowfer and Magistro, 1983)

Log  $K_{ow}$ : 1.36 (NIOSH, 1986)

Conversion factor: 1 ppm = 2.60 mg/m<sup>3</sup>, 1.0 mg/m<sup>3</sup> = 0.39 ppm

VC monomer is a synthetic chemical used as a chemical intermediate in the polymerization of polyvinyl chloride. At room temperature and pressure, it is a colorless gas with a mild, sweet odor. As the data shown above indicate, VC is moderately soluble in water. Structurally, VC is a haloalkene and is related to vinylidene chloride and trichloroethylene.

## 3. TOXICOKINETICS/TOXICODYNAMICS RELEVANT TO ASSESSMENTS

Human and animal data indicate that VC is rapidly and efficiently absorbed via the inhalation and oral routes, is rapidly converted to water-soluble metabolites, and is rapidly excreted. At low concentrations, VC metabolites are excreted primarily in urine, while at high exposure concentrations, unchanged VC is also eliminated in exhaled air. Overall, the data indicate that neither VC nor its metabolites are likely to accumulate in the body.

Absorption of VC in humans after inhalation exposure is rapid. A study conducted in five young adult male volunteers inhaling VC at concentrations of 7.5 to 60 mg/m<sup>3</sup> showed that 42% was retained, maximum retention was reached within 15 minutes, and the percent retention was independent of inspired VC concentration. After cessation of exposure, the VC concentration in expired air decreased rapidly within 30 minutes to 4% of the inhaled concentration (Krajewski et al., 1980). Animal inhalation studies also show that VC is rapidly absorbed. Exposure of male Wistar rats (number/group unspecified) to 1,000, 3,000, or 7,000 ppm VC (99.9% pure) for 5 hours using a head-only apparatus resulted in rapid uptake into the blood, as measured by gas-

liquid chromatography (GLC) (Withey, 1976). Equilibrium blood levels were achieved within 30 minutes for all exposures. Upon cessation of exposure, blood levels declined to a barely detectable level after 2 hours. Rat studies show that the distribution of VC is rapid and widespread, but the storage of VC in the body is limited by its rapid metabolism and excretion (Bolt et al., 1977).

No human studies of absorption of ingested VC were located. Animal studies show that VC absorption following oral exposure is rapid and complete. Peak blood levels were reached within 10 minutes when VC was administered to male rats by gavage in an aqueous solution at doses up to 92 mg/kg (Withey, 1976). In the same study, more complex and slightly delayed absorption was observed following VC gavage in oil, although peak blood levels were reached within 40 minutes (Withey, 1976). At 72 hours after a single gavage dose of 100 mg/kg VC in oil, unmetabolized VC was detected in exhaled air, indicating that metabolism was saturated (Watanabe and Gehring, 1976; Watanabe et al., 1976a). Saturation of VC metabolism has also been observed following inhalation exposure (Watanabe and Gehring, 1976; Watanabe et al., 1976b). In rats fed VC monomer in a PVC powder, the average amount of VC detected in feces was 8%, 10%, and 17% for oral intake of 2.3, 7.0, and 21.2 mg/kg-day (Feron et al., 1981). As the remaining material was reported as still enclosed in PVC granules, VC monomer was nearly, if not completely, absorbed in the GI tract. Complete absorption of VCM was therefore assumed in the choice of a measure of oral exposure.

Numerous studies on the pharmacokinetics and metabolism of VC have been conducted, with the majority of these studies conducted in rats (Withey, 1976; Hefner et al., 1975; Guengerich and Watanabe, 1979; Bolt et al., 1976, 1977; Watanabe et al., 1976a,b, 1978; Jedrychowski et al., 1984, 1985; Tarkowski et al., 1980). As discussed in Sections 5.1.2, 5.2.2, and 5.3.3, both the cancer and noncancer assessments were conducted using a physiologically based pharmacokinetic (PBPK) model (Clewell et al., 1995a,b) in which VC metabolism was hypothesized to occur via two saturable pathways. Therefore, VC metabolism is discussed in some detail here as part of the background for the development of the model. A simplified diagram of the metabolism of VC is shown in Figure 1. The primary route of metabolism of VC is by the action of the mixed function oxidase (MFO) system, now referred to as cytochrome P450 or CYP, on VC to form chloroethylene oxide (CEO) (Bolt et al., 1977; Plugge and Safe, 1977). Chloroethylene oxide (CEO) is a highly reactive, short-lived epoxide that rapidly rearranges to form chloroacetaldehyde (CAA), a reactive  $\alpha$ -halocarbonyl compound; CEO is also a substrate for epoxide hydrolase (Pessayre et al., 1979).

These two metabolites are detoxified mainly via glutathione (GSH) conjugation (Jedrychowski et al., 1985; Leibman, 1977; Tarkowski et al., 1980). This hypothesis is supported by the observation of decreased nonprotein sulfhydryl concentrations at high VC exposure concentrations (Jedrychowski et al., 1985; Tarkowski et al., 1980), as well as by the excretion of GSH-conjugated metabolites in the urine, observed in rats following exposure to VC (Watanabe et al., 1976c; Hefner et al., 1975). CAA may also combine directly or enzymatically with GSH via glutathione transferase (GST) to form S-formylmethylglutathione. S-formylmethylglutathione, through direct interaction with GSH-derived cysteine, can be excreted as N-acetyl-S-(2-hydroxyethyl)cysteine, another major urinary metabolite of VC (Green and

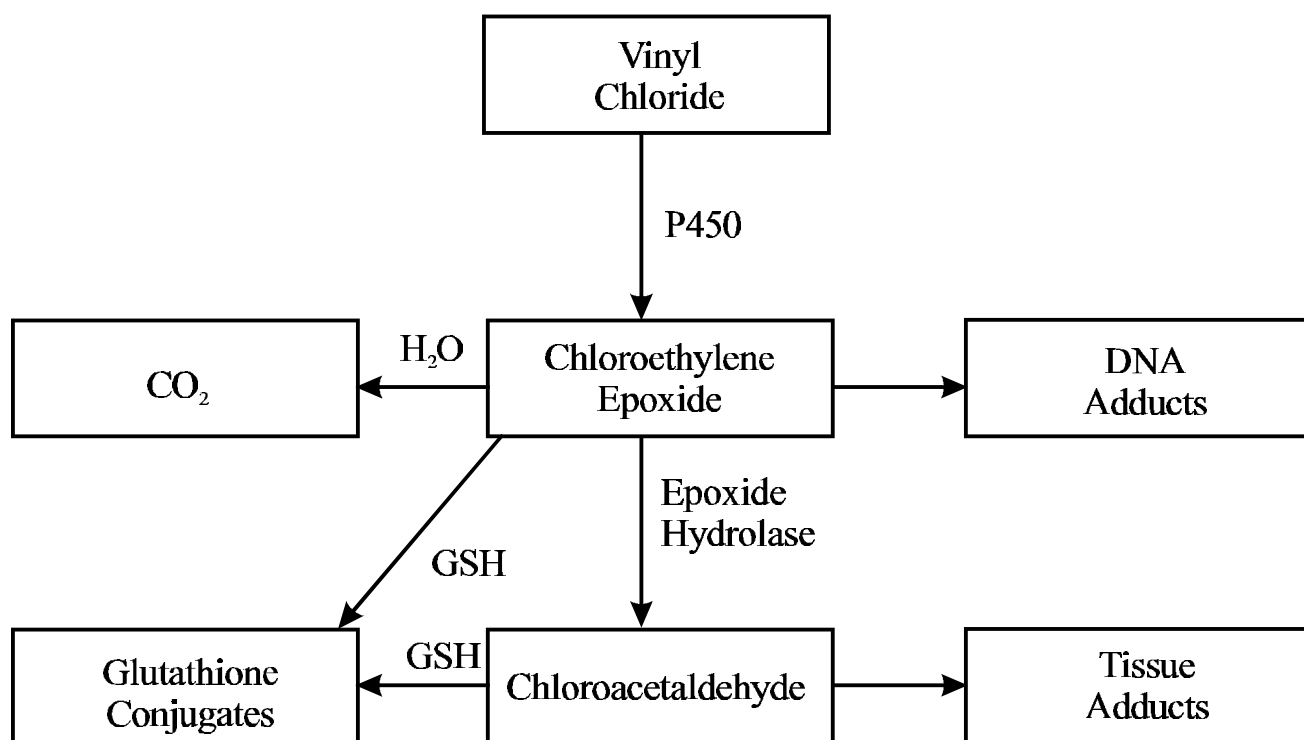

**Figure 1. Metabolism of vinyl chloride.**

Hathway, 1975). The GSH conjugates are then subject to hydrolysis, resulting in excretion of cysteine conjugates in the urine (Hefner et al., 1975). Two of the three major urinary metabolites of VC in rats have been identified as N-acetyl-S-(2-hydroxyethyl)cysteine and thiodiglycolic acid (Watanabe et al., 1976b).

The specific isozymes of the P450 system involved in the metabolism of VC have not yet been unequivocally established. However, it is clear from both *in vitro* and *in vivo* studies that several isozymes can play a role. High-affinity, low-capacity oxidation by CYP2E1 is probably responsible for essentially all of the metabolism of VC at low concentrations in uninduced animals and humans (Guengerich et al., 1991). There is also evidence for a significant increase in metabolism in animals pretreated with phenobarbital (Ivanetich et al., 1977), suggesting that CYP2B1 also metabolizes VC. At high concentrations *in vivo*, the metabolism of VC in rats leads to a destruction of P450 enzyme (Reynolds et al., 1975), which is greatly enhanced in phenobarbital- or Arochlor-induced animals (Arochlor induces CYP1A2). The loss of P450 has been suggested to result from the production of reactive intermediates during the metabolism of VC (Guengerich and Strickland, 1977) and is inhibited by GSH *in vitro* (Ivanetich et al., 1977). Induction of P450 by phenobarbital or Arochlor was also necessary to produce acute hepatotoxicity from VC in rats (Jaeger et al., 1977), indicating that VC toxicity is increased by increased P450 activity.

The contribution of several P450 isozymes to the metabolism of the related compound trichloroethylene (TCE) has been studied in the male Wistar rat and male B6C3F1 mouse (Nakajima et al., 1993). Using monoclonal antibodies specific to each isozyme, the investigators were able to determine that CYP2E1 contributes more to the metabolism of TCE in mice than in rats, whereas CYP2C11/6 contributes more to the metabolism of TCE in rats than in mice (CYP2C11/6 is a constitutive, noninducible isozyme present only in male rodents). The investigators also found that CYP1A1/2 contributes to the uninduced metabolism of TCE in mice but not in rats and that CYP2B1 does not contribute to the metabolism of TCE in naive animals of either species. Thus, assuming that the same isozymes are responsible for metabolism of TCE and VC, it appears that at low concentrations the initial metabolism of VC is primarily due to CYP2E1, but that at higher concentrations, where CYP2E1 becomes capacity limited, other CYP isozymes may contribute to its metabolism. The extent of this higher capacity metabolism is likely to vary across animal species, strain, and sex. To the extent that such higher capacity, lower affinity metabolism (referred to in future as “non-2E1” metabolism) may be important in conducting a risk assessment for VC, it will have to be characterized separately for each species, strain, and sex of interest. From a pharmacokinetic modeling perspective, non-2E1 metabolism would be handled as a second saturable metabolic pathway with a larger value for the Michaelis-Menten constant (KM). For example, it has been demonstrated that the metabolism of the related compound, vinyl bromide, is best described with two distinct saturable pathways having different affinities (Gargas and Andersen, 1982). Of major importance for human risk assessment, some of the low-affinity, high-capacity constitutive (2C11/6) and inducible (2B1/2) P450 isozymes in the rodent may have no human correspondents (Guengerich, 1987).

Reflecting the dose-dependent, saturable nature of VC metabolism, the route and nature of VC elimination is also dose related (Green and Hathway, 1975; Bolt, 1978; Hefner et al., 1975; Gehring et al., 1978). Following exposure via oral or inhalation routes to low doses of VC, metabolites are excreted primarily in the urine. However, once the saturation point for metabolism is reached, VC is eliminated via other routes, primarily exhalation of the parent compound (Watanabe et al., 1976b; Watanabe and Gehring, 1976). The route of elimination of VC also depends on the route of administration. Urinary excretion is favored more following oral or intraperitoneal administration, while 99% of the same dose administered intravenously was exhaled (Bolt, 1978). This may be the result of a high peak concentration with intravenous administration, combined with a relatively low blood-to-air partition coefficient, resulting in elimination via the lungs before a significant amount of urinary clearance can occur.

## 4. HAZARD IDENTIFICATION

### 4.1. STUDIES IN HUMANS—EPIDEMIOLOGY, CASE REPORTS, CLINICAL CONTROLS

#### 4.1.1. Cancer Effects

Several independent retrospective and prospective cohort studies demonstrate a statistically significant elevated risk of liver cancer, specifically angiosarcomas, from exposure to VC monomer (VCM) (Tabershaw and Gaffey, 1974; Wong et al., 1991; Byren et al., 1976; Waxweiler et al., 1976; Weber et al., 1981; Fox and Collier, 1977; Jones et al., 1988; Simonato et al., 1991; Monson et al., 1975; Wu et al., 1989; Pirastu et al., 1990). Although Duck et al. (1975) failed to find a significant increase in liver cancer, they did report one case of liver angiosarcoma. Significant excess risk of brain and central nervous system cancer has also been associated with VC exposure (Tabershaw and Gaffey, 1974; Wong et al., 1991; Weber et al., 1981; Byren et al., 1976; Cooper, 1981; Waxweiler et al., 1976; Wu et al., 1989). Several studies have found an association between VC exposure and cancer of the hematopoietic and lymphatic systems (Simonato et al., 1991; Weber et al., 1981); observed increases in other studies fell below statistical significance due to the small numbers of these types of cancers (Tabershaw and Gaffey, 1974). VC exposure has also been associated with lung cancer (Buffler et al., 1979; Monson et al., 1975; Waxweiler et al., 1976), although the evidence is less strong than for other cancers. Ott et al. (1975) reported an increase in deaths due to all malignancies, although none of them were due to angiosarcoma. An excess of melanoma was reported in one study (Heldaas et al., 1984), but other studies have not substantiated this report.

In 1974, a study (Creech and Johnson, 1974) reported for the first time an association between exposure to VC and cancer in humans: three cases of liver angiosarcoma were reported in men employed in a polyvinyl chloride (PVC) plant. Angiosarcoma of the liver is considered to be a very rare type of cancer, with only 20-30 cases per year reported in the United States (Gehring et al., 1978; ATSDR, 1995). As described in the following paragraphs, greater than expected incidences of angiosarcoma of the liver have since been reported in a number of other cohorts of workers occupationally exposed to VC.

While a large number of occupational studies reported an association between VC and liver angiosarcoma, quantitative exposure information is available for only a few studies. Fox and Collier (1977) reported four cases of liver cancer, two of which were angiosarcomas, in a cohort of 7,717 British VC workers. The study authors grouped the subjects by estimated exposure levels and exposure duration. From these data, average exposure levels have been estimated as 12.5, 70, and 300 ppm (Clement Associates, 1987) or 11, 71, and 316 ppm (Chen and Blancato, 1989). Because workers were classified based on the maximum exposure for each worker, cumulative exposure is overestimated, leading to a probable underestimation of risk using these data. Both angiosarcoma cases were considered to have had high exposure to VCM at the level of 200 ppm and above time-weighted average. There was no effect on other cancers in comparison with cancer rates in England and Wales. In a follow-up study, Jones et al. (1988) analyzed mortality in 5,498 male VC workers. This study found a significant excess of primary

liver tumors, with 11 deaths, 7 of which were angiosarcomas. The median latency for angiosarcomas was 25 years.

Simonato et al. (1991) reported on the results of a large multicentric cohort study of 12,706 VC/PVC workers. A significant increase in liver cancer deaths was observed (Obs = 24, SMR = 286). Workers were classified based on maximum exposure level into ranges of < 50 ppm, 50-499 ppm, and  $\geq$  500 ppm. Estimating an average exposure duration of 9 years, average exposure levels for these groups can be estimated at 25, 158, and 600 ppm. Histopathology was available for 17 of the liver cancers; 16 were confirmed as angiosarcoma and 1 was a primary liver cancer. The excess risk from liver cancer was related to the time since first exposure, duration of exposure, and estimated total exposure. An increased risk of lymphosarcoma was observed (SMR = 661, 95% CI = 136-1,931), but there was no relationship to duration of employment. Brain cancer had an elevated risk in certain analyses, but there was no clear relationship to exposure duration; there was no excess risk of lung cancer.

In a preliminary report with only 85% follow-up completed, Tabershaw and Gaffey (1974) compared mortality in a cohort of 8,384 men occupationally exposed to VC with death rates among U.S. males. Each VC plant classified workers as exposed to high, medium, or low levels of VC, but no quantitative estimate of exposure was provided, and no attempt was made to establish consistent gradations of exposure between plants or exposure periods. No significant increases in any general cancer classification were found. However, six cases of angiosarcoma identified by other investigators occurred in the study population; only two of these were identified as angiosarcomas on the death certificate. The study authors also noted that 6 of 17 (40%) deaths in the category "other malignancies" were due to brain cancer. The authors stated that only 22% of the deaths in this category would be expected to be due to this cause, but they did not provide any supporting documentation. This preliminary report also noted a slight excess risk of lymphomas (5 observed vs. 2.54 expected) in the group with the higher exposure index.

Cooper (1981) enlarged the Tabershaw and Gaffey (1974) study to include 10,173 VC workers; vital status was ascertained for 9,677 men. Cooper noted that, of the nine angiosarcomas identified in the U.S. during the study period, eight were included in the study cohort. Statistical analyses were conducted for broad categories of tumors; a significant increase (Obs = 12, SMR = 203,  $p < 0.05$ ) was observed for brain and central nervous system malignancies.

An update on this cohort (Wong et al., 1991) also found an association between VC exposure and angiosarcoma. Fifteen deaths from angiosarcoma were identified, a clear excess over the incidence in the general population, although no statistical analysis was conducted for this malignancy. This study also attempted to determine whether other cancers are associated with VC exposure. Excluding the 15 angiosarcomas identified from death certificates, a significant increase was observed in liver and biliary tract cancers alone (Obs = 22, SMR = 386,  $p < 0.02$ ). However, the study authors suggested that these 22 cancers probably included some cases of angiosarcoma that were misdiagnosed. Based on a comparison of death certificates and pathology records in 14 cases, the authors estimated that the correct number of primary liver/biliary tract cancers (excluding angiosarcomas) is 14, which is still significantly increased over background (SMR = 243,  $p < 0.01$ ). Although this is an estimate, liver cells were the

primary target site in 8 of the 14 pathology records. It can thus be assumed that VC is capable of inducing both liver angiosarcoma and hepatocellular carcinoma. This study also found a significantly increased risk of cancer of the brain and central nervous system (Obs = 23, SMR = 180,  $p < 0.05$ ). There was no excess in cancer of the respiratory system or the lymphatic and hematopoietic systems. Expected deaths were based upon U.S. mortality rates, standardized for age, race, and calendar time.

CMA (1998b) updated the Wong et al. (1991) study through 1995. This study was also designed to evaluate possible induction of cancer at sites other than the liver. In this study all liver and biliary cancers were included in a single category. Mortality rate for these cancers, based upon 80 deaths, was again significantly increased (SMR=359; 95% CI: 284-446). The SMRs increased with duration of exposure from 83 (95% CI: 33-171), to 215 (95% CI: 103-396), to 679 (95% CI: 483-929), to 688 (95% CI: 440-1023) for those exposed from 1-4 years, 5-9 years, 10-19 years and 20 years or more, respectively. Mortality from brain and CNS cancer showed an excess based on 36 deaths (SMR=142; 95% CI: 100-197). The elevation was statistically significant for those exposed 5-9 years (SMR=193; 95% CI: 96-346), and for those exposed 20 years or more (SMR=290; 95% CI: 132-551). Finally, mortality from connective and other soft tissue cancers, based upon 12 deaths, was also increased significantly (SMR=270; 95% CI: 129-472). The increases were significant for those exposed 10-19 years (SMR=477; 95% CI: 155-1113) and 20 or more years (SMR=725; 95% CI: 197-1856). This cause of death category had not been evaluated in the Wong et al. (1991) study. Overall, excess deaths due to liver and biliary tract cancer is estimated to be about three times that of CNS, connective and soft tissue cancers combined. Deaths were based upon regional (State weighted) mortality rates for white males.

Byren et al. (1976) reported a significantly elevated risk of pancreas/liver cancer (4 observed vs. 0.97 expected) in a cohort of 750 Swedish workers exposed to VC. Two of the four were identified as angiosarcomas of the liver only after reevaluation. The primary diagnosis was one pancreatic cancer and one liver cancer. The excess risk increases when latency is considered. The expected number of deaths was 0.68 for a latency period of > 10 years, while all 4 observed deaths were exposed earlier than 10 years before death. This study also found a small excess of brain cancer (2 observed vs. 0.33 expected).

Waxweiler et al. (1976) found a significantly elevated risk (7 observed vs. 0.6 expected) of liver cancer in a cohort of 1,294 workers who were exposed to VCM for a minimum of 5 years and followed for 10 or more years. In a separate phase of the study, the authors identified 14 cases of liver and biliary cancer, 11 of which were angiosarcomas. Several of the identified subjects were not included in the main study because they were still alive, or because they did not meet the minimum criteria for inclusion in the cohort. Brain cancer incidence was significantly increased in workers observed for 15 years or more after initial exposure (3 observed vs. 0.6 expected); a nonsignificant increase was observed for a 10-year latency. An additional seven cases of brain cancer were identified in subjects who did not qualify for inclusion in the cohort study. Nine of the ten brain cancers were glioblastoma multiforme; a histological analysis was not available for the tenth. By contrast, the study authors stated that this distribution of cell type typically occurs in only 33% of brain cancer deaths. The cohort study also found a slight excess risk of lymphatic and hematopoietic system cancer (4 observed vs. 2.5 expected). Of the 14 cases



of primary lung cancer identified, 5 were large cell undifferentiated, 3 were adenocarcinomas, and there were no squamous cell or small cell bronchiogenic carcinomas, suggesting that these cancers were not associated with smoking. In a study of 4,806 workers at the same plants, including those workers exposed to chemicals other than VCM, an elevated risk of lung cancer was found for workers exposed to PVC dust, but not for workers exposed to VCM (Waxweiler et al., 1981). The study authors stated that the association with PVC dust could also have been due to VCM trapped in the dust, but they noted that this did not explain the fact that exposure to VCM was not associated with lung cancer in their study.

Wu et al. (1989) investigated a cohort of 2,767 VCM workers, most of whom had been employed for fewer than 5 years. There was a significant excess risk of liver cancer (14 observed vs. 4.2 expected). The incidence of angiosarcomas was not reported, but 12/18 liver cancers were angiosarcomas in a larger cohort of 3,620 workers that included workers exposed to PVC, as well as the VCM workers. In a case-control study with the controls taken from a National Institute for Occupational Safety and Health (NIOSH) database, angiosarcomas were related to higher cumulative exposure to VCM, but other liver cancers were not. Brain and lung cancer were not elevated for the VCM workers but were elevated for the combined cohort.

Weber et al. (1981) examined mortality patterns in 7,021 German and Austrian VCM/PVC workers and 4,007 German PVC processing workers. Comparisons were with West German population death rates. A significantly elevated risk of liver cancer (12 observed vs. 0.79 expected) was observed in the VCM/PVC cohort, but a significant increase (4 observed vs. 1 expected) was also observed in an unexposed reference group. However, the risk in the VCM cohort increased with exposure duration. The study authors implied that four cases of angiosarcoma were identified in the study cohort, although it was not clear if all of the cases belonged to this cohort. A significant excess risk of brain cancer (Obs = 5, SMR = 535,  $p < 0.05$ ) was also observed in the PVC processing workers, but not in VCM/PVC workers. Risk of lymphatic and hematopoietic cancer (Obs = 15, SMR = 214) was significantly increased in VCM/PVC production workers, and there was a tendency for increased risk at longer exposure durations.

In a proportionate mortality study analyzing the causes of death of 142 workers exposed to VCM or VC/PVC, Monson et al. (1975) found an excess incidence of liver cancer (8 observed vs. 0.7 expected). Five of these were angiosarcomas. The study also found an excess of brain cancer (5 observed vs. 1.2 expected) and lung cancer (13 observed vs. 7.9 expected); all three of the brain tumors for which the type was identified were glioblastoma multiformae. No statistical analysis was conducted by tumor target.

Pirastu et al. (1990) evaluated clinical, pathological, and death certificate data for 63 deaths in three VCM/PVC manufacturing or PVC extruding plants. Fourteen deaths from primary liver cancer were found, seven of which were identified as angiosarcoma and two of which were hepatocellular carcinoma. No comparison to a control population was conducted. However, the authors stated that this study indicated a relationship between VC exposure and primary liver cancer, as well as with angiosarcoma.

In a mortality follow-up study of 464 workers at a VCM production facility, a significant excess of respiratory cancers was observed (Obs = 5, SMR = 289,  $p < 0.03$ ). The excess remained after correction for smoking and was associated with longer exposure durations and higher exposure levels. Belli et al. (1987) also found a significant excess of lung cancer in a preliminary report of a cohort of 437 VCM/PVC workers.

Lelbach (1996) reported on the course of VC-induced disease in 21 PVC production workers. Death was due to liver cancer in 19 of these cases. While the predominant tumor type was angiosarcoma, hepatocellular and colangiocellular carcinoma were also found. Latency periods ranged from 12 to 34 years, with a mean of 22 years. Younger age at first exposure, younger than 27 years, seemed to have been accompanied by shorter latency periods.

Lee et al. (1996) described the time course and pathology of 20 patients who died from angiosarcoma of the liver after occupational exposure to VC in Great Britain. Exposure periods ranged from 3 to 29 years, with tumors developing after 9 to 35 years from beginning of exposure.

The annual incidence of angiosarcoma of the liver in Great Britain from all sources was estimated to be about 1.4 cases per 10 million population (Elliot and Kleinschmidt, 1997). Of 10 cases that were confirmed as angiosarcomas by histological analysis, 9 were VC workers. The other individual was employed at a VC factory, although not as a VC worker. Since even this individual could be presumed to have some exposure to VC, it was concluded that there were no confirmed nonoccupationally exposed cases of angiosarcoma among residents living near a VC site in Great Britain.

Smulevich et al. (1988) investigated a cohort of 3,232 workers (2,195 men, 1,037 women) in a Soviet VC/PVC chemical plant. No cases of angiosarcoma or other liver tumors were reported. Workers who were highly exposed to VC ( $> 300 \text{ mg/m}^3$ ) had a significantly elevated risk of lymphomas and leukemias (apparently 7 observed vs. about 1.1 expected for combined men and women, but there are inconsistencies in the reported numbers). The risk of brain cancer was elevated in women (Obs = 2, SMR = 500), but the effect was not significant and the incidence in men was unaffected.

In conclusion, there exists strong evidence of a causal relationship between exposure to VC/VCM in humans and a significantly excess risk of angiosarcoma; the highest relative risk is associated with this cancer type. There is highly suggestive evidence of a causal relationship with other liver cancers, brain cancer, and cancer of the lymphopoietic system. Lung cancer has also been associated with VC exposure, but based on the data of Waxweiler et al. (1981), the increased risk of lung cancer observed in some cohorts may be due to exposure to PVC dust rather than VCM. This may explain some of the inconsistencies regarding a relationship between VC exposure and lung cancer, since some studies investigated cohorts exposed only to VCM while other cohorts were exposed to VCM and/or PVC dust.

As discussed in Section 5.3, the dose-response assessment was based on liver angiosarcomas, angiomas, hepatomas, and neoplastic nodules because liver tumors lead to the strongest causal association with VC exposure and because angiosarcomas in particular are rare in

unexposed humans and laboratory animals. Furthermore, attempts to estimate cancer risk for other sites, such as mammary glands, resulted in much greater uncertainty because responses were quite variable and not always statistically significant, and because the magnitude of the cancer risk estimated was, with few exceptions, less than the risk of liver tumors. Finally, although cancer incidence was reported to be significantly increased at two other sites in a recent epidemiology study (CMA, 1998b), the estimated increase in mortality from cancer at these sites was still much less than for liver cancer.

#### 4.1.2. Noncancer Effects

Several epidemiology and case studies have associated chronic occupational exposure to VC with impaired liver function and/or biochemical or histological evidence of liver damage, notably subcapsular, portal and perisinusoidal fibrosis, hyperplasia of hepatocytes and sinusoidal cells, and portal hypertension (Buchancova et al., 1985; Doss et al., 1984; Gedigk et al., 1975; Lilis et al., 1975; Marsteller et al., 1975; Popper and Thomas, 1975; Tamburro et al., 1984). Focal hepatocellular hyperplasia and focal mixed (hepatocytes and sinusoidal cells) hyperplasia are early histological alterations indicative of VC exposure (Popper and Thomas, 1975) and are the principal anatomic lesions in VC-associated liver disease (Berk et al., 1976). Doss et al. (1984) reported coproporphyrinuria in 46 males occupationally exposed to VC for 18 months to 21 years. Gedigk et al. (1975) correlated liver damage manifested as parenchymal damage, fibrosis, and proliferation of the sinusoidal cells with duration of exposure to VC in 51 patients. The severity of degenerative lesions increased with increasing duration of exposure and appeared to be reversible upon exposure cessation. Another study reported the progressive nature of the liver changes that resulted in “chronic hepatitis” (Lilis et al., 1975). Thresholds for hepatotoxicity cannot be identified because data regarding exposure concentrations and duration were not available. The symptoms and signs of liver disease associated with occupational exposure to VC include pain or discomfort in the right upper quadrant of the abdomen, hepatomegaly, splenomegaly, and thrombocytopenia, in addition to fibrosis, cirrhosis, and portal hypertension; however, these observations are not pathognomonic for VC-induced liver disease (Lilis et al., 1975; Marsteller et al., 1975; Popper and Thomas, 1975). Fibrosis frequently occurs in the elderly and in patients with diabetes mellitus (Popper and Thomas, 1975).

Ho et al. (1991) reported VC-related liver dysfunction in 12 of 271 workers who were exposed to environmental levels of 1 to 20 ppm, with a geometric mean of 6 ppm (15 mg/m<sup>3</sup>). The affected workers were identified as a result of a medical surveillance program of biochemical liver function tests. Latent periods from first exposure to the first abnormal test ranged from 1 to 13 years. In addition to repeated abnormalities in liver function tests, most affected subjects had hepatomegaly and/or splenomegaly. While this study suggests effects at very low levels, the exposure assessment may well be flawed. According to Tamburro (personal communication, Arlo H. Tamburro, M.D., M.P.H., University of Louisville Medical School, 1997), concentrations of VC during tank washing of tanks may have been as high as 2,000 to 5,000 ppm and have been reported to be as high as 10,000 ppm during tank washing. The occurrence of abnormal biochemical liver tests also showed no relationship to likely exposure level based upon job classification. Du et al. (1995) found that serum levels of gamma-glutamyl transferase (GGT), but not other indicators of liver function, correlated with exposure in a group of 224 VC workers

with time-weighted average exposure ranging from 0.36 to 74 ppm (0.92 to 189 mg/m<sup>3</sup>). Hepatomegaly, altered liver function as shown by biochemical tests, and Raynaud's phenomenon (cold sensitivity and numbness of fingers) were reported in chemical plant workers exposed to 25 to 250 ppm VC (64 to 639 mg/m<sup>3</sup>) (Occidental Chemical Corporation, 1975).

An occupational study attempted to correlate the effects of VC with the liver function of exposed workers (77 total), as measured by the plasma clearance of the <sup>99m</sup>Tc-N-(2,4-dimethylacetanilido)iminodiacetate (HEPIDA) complex (Studniarek et al., 1989). The duration of exposure varied from 3 to 17 years. Personal air samplers were used to determine the mean VC concentrations in 1982 at various regions of the plant. Polymerization operators (n = 13) had the highest mean exposure to VC, 30 mg/m<sup>3</sup>, with a mean duration of employment of 10 years. Autoclave cleaners (n = 9) and auxiliary personnel (n = 12) in polymerization rooms were exposed to mean concentrations of 9 mg/m<sup>3</sup> for a mean duration of 8 and 12 years, respectively, while technical supervisors (n = 6) had the lowest mean VC exposure of 6 mg/m<sup>3</sup> for a mean duration of 13 years. The investigators found a significant correlation between degree of exposure to VC and the frequency of low clearance values; however, no concentration-response relationship was detected among the groups with respect to plasma clearance of <sup>99m</sup>Tc-HEPIDA. This study is of limited value since personal air sampling was conducted for only 1 year. The yearly geometric means of VC atmospheric concentrations in various departments of the plant were provided, but these concentrations fluctuated dramatically between 0.1 and 600 mg/m<sup>3</sup> from 1974 to 1982.

There was no evidence of decrements in pulmonary function over the course of a work shift in a group of 53 chemical, plastics, and rubber workers exposed to higher VC levels (up to 250 ppm, 639 mg/m<sup>3</sup>) (Occidental Chemical Corporation, 1975). In an analysis of causes of death in a cohort of 10,173 VC workers for up to 30 years after the onset of exposure, the only noncancer cause for which the SMR was significantly elevated was emphysema (Dow Chemical Company, 1986). There was no correlation with exposure duration or latency. There was also no control for smoking, although there was no excess of lung cancer.

Insufficient data exist to evaluate the teratogenicity of VC in humans. Several epidemiology studies have investigated the effects of inhalation exposure to VC on the incidence of fetal loss and birth defects (Hatch et al., 1981; Infante et al., 1976; Waxweiler et al., 1977); however, no solid association has been found. Studies of communities near VC plants (Edmonds et al., 1978; Theriault et al., 1983) have found no clear association between parental residence in a region with a VC plant and the incidence of birth defects in the exposed community.

Fontana et al. (1995) reported a 9% occurrence of clinical symptoms of Raynaud's phenomenon (RP) in 128 retired patients who were exposed occupationally to VC. While RP secondary to VC exposure can still persist after the end of exposure, capillary lesions did not appear as the main physiologic factor in the persistence of the RP.

## 4.2. PRECHRONIC AND CHRONIC STUDIES AND CANCER BIOASSAYS IN ANIMALS—ORAL AND INHALATION

Feron et al. (1981) administered diets containing 10% PVC with varying proportions of VCM to Wistar rats. Diets were available to experimental animals for 4 hours per day, and food consumption and VC concentrations were measured at several times during the feeding period in order to account for loss of VC from the diet due to volatilization. This information was used to calculate the ingested dose. Evaporative loss averaged 20% over 4 hours. The ingested dose was adjusted downward by the amount of VC measured in the feces to arrive at the bioavailable doses of 0, 1.7, 5.0, or 14.1 mg/kg-day which were fed to Wistar rats (n = 80, 60, 60, and 80, respectively) for a lifetime. An additional group of 80/sex were administered 300 mg/kg-day by gavage in oil for 5 days/week for 83 weeks. Rats were weighed at 4-week intervals throughout the study. Hematological values were obtained at 13, 26, 52, 78, and 94 weeks, and blood chemistry was performed at 13, 26, 52, and 106 weeks (n = 10). Urinalysis was performed on 10 animals per group at 13, 25, 52, 78, and 94 weeks. All surviving animals were necropsied at week 135 (males) or week 144 (females). Interim sacrifices of 10 animals at 26 and 52 weeks included animals from the control and high-dose groups.

Feron et al. (1981) reported that there was no difference in body weights in the VC-treated animals, although all groups (including the control) weighed significantly less than the controls fed ad lib (treated animals had access to food for only 4 hours/day). Significant clinical signs of toxicity in the 5.0 and 14.1 mg/kg-day groups included lethargy, humpbacked posture, and emaciation. Significantly increased mortality was seen consistently in males at 14.1 mg/kg-day and in females at 5.0 and 14.1 mg/kg-day. No treatment-related effects on hematology, blood chemistry, or urinalysis parameters were observed. Relative liver weight was significantly increased at 14.1 mg/kg-day but was not reported for the other dose groups.

In the Feron et al. (1981) study, a variety of liver lesions were observed histologically to be dose related and statistically significant in male and female rats. These included clear cell foci, basophilic foci, eosinophilic foci, neoplastic nodules, hepatocellular carcinoma, angiosarcoma, necrosis, cysts, and liver cell polymorphism. Several of these endpoints were significantly increased in the group exposed to 1.7 mg/kg-day. Furthermore, basophilic foci were significantly ( $p < 0.05$ ) increased at doses as low as 0.014 mg/kg-day and liver cell polymorphisms at doses as low as 0.13 mg/kg-day in a related study conducted at lower doses (Til et al., 1983, 1991); the Til et al. (1983) study is described in more detail below. The above lesions, with the exception of the angiosarcoma and bile duct cysts, derive from hepatocytes; angiosarcoma is derived from sinusoidal cells and cysts from bile duct epithelium. Because the neoplastic nodules and altered hepatocellular foci are proliferative lesions indicative of changes in the cells from which hepatocellular carcinomas are derived, and because these lesions occur at lower doses and higher incidences than the hepatocellular carcinomas, these lesions are likely to be preneoplastic. In addition, the fact that they occur at doses one to two orders of magnitude lower than other liver lesions, such as necrosis, indicates that these lesions probably occur via a genotoxic mechanism, consistent with the known mechanism of VC carcinogenicity. By contrast, there are no indications that VC causes cancer via a cytotoxic mechanism, so the necrosis is not considered a preneoplastic effect. The incidence of necrosis was increased in a dose-related manner in both males (4/55 in controls, 4/58, 8/56, and 23/59 low to high dose) and females (5/57 in controls,

6/58, 19/59, and 27/57, low to high dose). The incidence was statistically significant in males receiving 14.1 mg/kg-day and in females receiving 5.0 mg/kg-day. Liver cell polymorphism, another endpoint not considered preneoplastic (Schoental and Magee, 1957, 1959), was also significantly increased in males only (4/55 in controls, 16/58, 28/56, and 42/59 low to high dose). Hepatic cysts were increased in females in a dose-related manner (9/57 in controls, 30/58, 41/59, and 49/57 low to high dose), whereas in males they were significantly increased only at the highest dose (16/59). Proliferation of sinusoidal cells showed a dose-related increase in males but did not achieve statistical significance. Increased tumor incidence was noted in all treated groups. Almost exclusively angiosarcomas were observed in males and females administered 300 mg/kg-day by gavage, while a mixture of angiosarcomas and hepatocellular carcinomas was observed at the mid and high dietary doses. Only hepatocellular carcinomas were reported at the low dose. Several other rare tumors were identified as possibly being associated with VC exposure. At least some of the observed pulmonary angiosarcomas (significant at  $p < 0.05$ ) and extrahepatic abdominal angiosarcomas appeared to be primary tumors, since they were observed in animals with no liver angiosarcoma. The incidence of Zymbal gland tumors, a rare tumor type, also increased. These neoplasms occurred at and above doses of 5 mg/kg-day. Abdominal mesotheliomas were elevated over controls in all dosed groups, but there was no clear dose response. Incidence and analysis of tumors in this study are presented in Section 5.3.2.

The lifetime dietary study of Til et al. (1983, 1991) was performed in order to study a range of oral doses below that delivered in the Feron et al. (1981) study, since tumors were observed at all doses in the previous study. The oral doses were delivered in the same way except that the diets contained a final concentration of 1% PVC, rather than 10%. Wistar rats (100/sex/dose) were administered doses (corrected for evaporative loss and the nonabsorbed portion in the feces) of 0, 0.014, 0.13, or 1.3 mg VC/kg/day for 149 weeks. Mortality differences were not remarkable for males but were slightly increased for females receiving 1.3 mg/kg-day. Relative organ weights were not evaluated. Angiosarcomas were observed in one high-dose male and two high-dose females. Other significant increases in tumors were limited to neoplastic nodules in females and hepatocellular carcinomas in males. No Zymbal gland tumors or abdominal mesotheliomas were observed. Testicular effects were not evaluated. An increased incidence of basophilic foci in liver cells was observed in both sexes at 1.3 mg/kg-day and only in females in the two lower dosage groups. Significant increases in females having “many” hepatic cysts (3/98 in controls, 4/100, 9/96, and 24/29 low to high dose) as well as liver cell polymorphism in males (incidence of moderate + severe of 5/99 in controls, 5/99, 8/99, and 13/49 low to high dose) and females (incidence of moderate + severe of 16/98 in controls, 16/100, 12/96, and 24/49 low to high dose) were reported. Since these latter two endpoints were the only ones not considered to be neoplastic or preneoplastic, they were considered suitable for development of RfDs and RfCs.

As described in Section 5.1.2, the PBPK model of Clewell et al. (1995b) was used to derive dose metrics that were then used to convert the exposure levels for the endpoints of interest in the animal studies to equivalent human exposure levels. In addition, because there are no direct effects at the portal of entry, the PBPK model was also used to derive dose metrics that were then used to convert the oral exposure levels used by Til et al. (1983, 1991) to a continuous human inhalation exposure concentration that would result in the same internal dose as occurred in the animal study. This study defines a no-observed-adverse-effect level (NOAEL) of 0.13

mg/kg-day and a lowest-observed-adverse-effect level (LOAEL) of 1.3 mg/kg-day for liver effects that are not thought to be preneoplastic. Using the PBPK model of Clewell et al. (1995b), a NOAEL(HEC [human equivalent concentration]) and LOAEL(HEC) of 4.4 and 44.4 mg/m<sup>3</sup>, respectively, were calculated. Benchmark dose (BMD) modeling was then conducted on the internal dose metrics calculated using the PBPK model, and the BMD at a benchmark response of 10% extra risk (BMD<sub>10</sub>) was calculated and evaluated. Due to limitations in the data and variable outputs from the BMD models, the NOAEL was chosen for use in further quantitative analysis.

Bi et al. (1985) exposed Wistar rats (apparently 75 per group) to 0, 10, 100, or 3,000 ppm VC (99.99% pure) for 6 hours/day, 6 days/week (duration adjusted to 0, 5.5, 55, 1,643 mg/m<sup>3</sup>, respectively) for up to 12 months. Animals were weighed monthly and observed daily for clinical signs. Interim sacrifices were reported at 3 (n = 8), 6 (n = 30), 9 (n = 6), and 12 (n = 10) months, with surviving animals examined after 18 months (6 months after the end of exposure). Organ weights and histopathology were reported to have been assessed on lung, liver, heart, kidney, testes, spleen, and brain, but only partial organ weight information was presented, and only testicular histopathology results are discussed in the report. Body weight was significantly decreased in the mid- and high-exposure groups (320, 310, 280, and 240 g in 0, 10, 100, and 3,000 ppm groups, respectively). Liver body weight ratios were increased in a concentration-dependent manner after 6 months at all dose levels. At 12 months, increased relative liver weight was observed only in the 3,000 ppm group, although the power to detect this effect was limited by the small number of animals examined. No effect on liver weight persisted at 18 months after the start of the exposure. Relative kidney weight in the 3,000 ppm group was increased at 3 and 12 months but not at 6 or 18 months, and in the 100 ppm group only at 18 months. Relative testes weight was decreased in the 100 and 3,000 ppm groups at 6 months, but the effect was not concentration related in that the relative testes weight was less at 100 than at 3,000 ppm and no other time points showed significant effects. There were several groups with significant differences in relative heart or spleen weights, but these were not consistent across exposure concentrations or durations and thus do not appear to be exposure related. The study did not report absolute organ weights, relative weights for groups with no significant differences, standard deviations, or histopathology results (except in the testes), making the organ weight differences in tissues other than the liver and testes difficult to interpret, although spleen size has been reported in other animal and human studies. The incidence of damage to the testicular seminiferous tubules in rats (n = 74) exposed to 0, 10, 100, or 3,000 ppm was 18.9%, 29.7%, 36.5%, and 56%, respectively. The incidence was statistically elevated at 100 and 3,000 ppm (duration adjusted to 55 and 1,643 mg/m<sup>3</sup>, respectively) ( $p < 0.05$  and  $p < 0.001$ , respectively) compared with controls and was concentration related. This damage consisted of cellular alterations, degeneration and necrosis. Thus, 10 ppm (duration adjusted to 5.5 mg/m<sup>3</sup>) is considered a LOAEL for liver weight changes and the NOAEL for biologically significant testicular degeneration.

As described for the Til et al. (1983, 1991) study, this concentration was converted to an HEC using the PBPK model of Clewell et al. (1995b), and benchmark modeling was then conducted on the dose metric when possible. Thus, the LOAEL(HEC) for increased relative liver weight is 47.8 mg/m<sup>3</sup>, and the NOAEL(HEC) for increased testicular degeneration is 73.4 mg/m<sup>3</sup>. The testicular degeneration was the only effect in this study that was suitable for benchmark modeling because no measure of variability (e.g., standard deviation) was provided for the liver

weight endpoint. The HEC based on the benchmark analysis benchmark concentration (BMC)(HEC) and the PBPK model is 316 mg/m<sup>3</sup>. The liver is more sensitive, and the LOAEL(HEC) is the most appropriate dose-response value in this study.

Du et al. (1979) exposed male Sprague-Dawley rats for 2-8 hours/day over periods of 1-5 weeks to 15,000 ppm VC. The total accumulated exposure period varied from 14-137 hours. Activity of glucose-6-phosphatase in the microsomal fraction decreased 25% with respect to controls after 70 hours of exposure. Glucose-6-phosphate dehydrogenase activity increased twofold after more than 100 hours of exposure. Nonprotein sulfhydryl levels (glutathione and/or cysteine) showed a slight but progressive elevation, whereas glutathione reductase increased 50%-60% during exposure. Dilatation of rough endoplasmic reticulum and patchy lesions near the plasmalemma were also noted. The pathology and early enzymatic changes were considered a reflection of mild early injury to liver cells.

In a study by Sokal et al. (1980), male Wistar rats (7-34/sex/group) were exposed to 0, 50, 500, or 20,000 ppm VC for 5 hours/day, 5 days/week (duration adjusted to 0, 19, 190, or 7,607 mg/m<sup>3</sup>, respectively) for 10 months. Hematological indices, blood chemistry, and urinalysis were evaluated after 1, 3, 6, and 10 months of exposure (n = 7-10). Histopathology was conducted on all major organs, including the lungs, with groups sacrificed at 1.5, 3, 6, and 10 months of exposure. The number of animals in each group is not clear from the report. Ultrastructural examination of the liver was carried out at 3, 6, and 10 months. No statistically significant differences were observed for urinalysis, hematological, or biochemical indices. No adverse effects on the lung were reported. There was a statistically significant ( $p < 0.05$ ) decrease in body weight at 10 months in all treatment groups relative to the controls that was biologically significant (i.e., > 10%) in the high-exposure group only. Organ weights were reported for groups of seven animals exposed for 10 months. Relative spleen, kidney, and heart weights were significantly elevated in some groups, but there was no change in absolute weight and no histological changes or effects on kidney function to corroborate an adverse effect in these organs. Relative liver weight was increased at 500 and 20,000 ppm, and absolute liver and testes weights were increased at 50,000 ppm. Treatment-related histological changes developed in the liver and testes. After 10 months, there was a significant increase in polymorphism of hepatocytes (2/28, 5/21, 18/34, and 10/17 in 0, 50, 500, and 20,000 ppm groups, respectively) and proliferation of reticuloendothelial cells lining the sinusoids (3/28, 3/21, 13/34, and 8/17 in 0, 50, 500, and 20,000 ppm groups, respectively). These effects were also seen at 6 months in the 500 and 20,000 ppm groups (incidences not reported). Fatty degeneration was also observed, and ultrastructural changes, including proliferation of smooth endoplasmic reticulum and lipid droplets, were reported, but no data were given. The report indicated that more detailed description of the histopathology and ultrastructure would be published separately, but no such record was found. Damage to the spermatogenic epithelium was significantly higher than in controls following exposure to 500 ppm (3/28, 3/21, 13/34, and 5/17 in the 0, 50, 500, and 20,000 ppm groups, respectively). A NOAEL of 50 ppm was identified for hepatocellular and testicular histopathology. Using the PBPK model of Clewell et al. (1995b), the NOAEL of 50 ppm corresponds to a duration-adjusted NOAEL(HEC) of 162 mg/m<sup>3</sup> for liver effects and a NOAEL(HEC) of 252 mg/m<sup>3</sup> for testicular effects. Applying benchmark modeling using the dosimetry provided by the PBPK model in the same manner as described for Til et al. (1983, 1991), the BMC(HEC) values are 102-293 mg/m<sup>3</sup> for liver effects (102 mg/m<sup>3</sup> for polymorphism



of hepatocytes, 160 mg/m<sup>3</sup> for proliferation of reticuloendothelial cells, and 293 mg/m<sup>3</sup> for the continuous endpoint of increased relative liver weight) and 212 mg/m<sup>3</sup> for testicular effects.

In a related study (Wisniewska-Knypl et al., 1980), male Wistar rats (7-10/group) were exposed under dynamic conditions to nominal concentrations of 50, 500, or 20,000 ppm VC or to air only for 5 hours/day, 5 days/week (duration adjusted to 19, 190, or 7,607 mg/m<sup>3</sup>, respectively) for 10 months with interim sacrifices at 1, 3, and 6 months. This study appears to be a different experiment from that reported by Sokal et al. (1980) based on different initial animal weights and chemical purity, although this is not entirely clear. Body weight was significantly affected only in the 20,000 ppm group exposed for 10 months. Tissue examinations were limited to the liver. Relative liver weight was increased at all sacrifice times at 500 and 20,000 ppm. Ultrastructural examination of liver tissue from animals exposed to 50 ppm showed hepatocellular changes characterized by proliferation of smooth endoplasmic reticulum at 3 months and accumulation of lipid droplets at 10 months. Rats exposed to 500 ppm for 3 months exhibited hypertrophy of the smooth endoplasmic reticulum, distension of canals of rough-surfaced membranes, swelling of mitochondria, and an increased number of lipid droplets in cytoplasm; these changes were more intensive at 20,000 ppm. No quantitative information is provided on the liver ultrastructural effects. This study identifies a minimal LOAEL of 50 ppm (duration adjusted to 19 mg/m<sup>3</sup>) for minor liver histopathology and a NOAEL of 50 ppm for liver weight effects. Based on the PBPK model of Clewell et al. (1995b), this corresponds to a duration-adjusted LOAEL(HEC) of 137 mg/m<sup>3</sup>. Applying benchmark modeling to the liver weight data in the same manner as described for Feron et al. (1981), the BMC(HEC) values are 293 mg/m<sup>3</sup> for increased relative liver weight. The liver ultrastructural data are not amenable to benchmark analysis because only descriptive information was presented.

In a study by Torkelson et al. (1961), several species of animals were exposed to 0, 50, 100, 200, or 500 ppm VC via inhalation for up to 6 months. Hematologic determinations, urinalysis, clinical biochemistry, organ weight measurement, and histopathology examination were conducted. Rats (24/sex/group), guinea pigs (12/sex/group), rabbits (3/sex/group) and dogs (1/sex/group) exposed to 50 ppm (127.8 mg/m<sup>3</sup>) for 7 hours/day for 130 days in 189 days did not exhibit toxicity as judged by appearance, mortality, growth, hematology, liver weight, and pathology. At an exposure concentration of 100 ppm administered 138-144 times in 204 days, a statistically significant increase in the relative liver weight of male and female rats was noted. Exposure to 200 ppm (138-144 times in 204 days) for 6 months resulted in increased relative liver weight in male and female rats, but there was no biochemical or microscopic evidence of liver damage. Rabbits exposed under the same conditions exhibited histological changes (characterized as granular degeneration and necrosis with some vacuolization and cellular infiltration) in the centrilobular area of the liver. There was no effect at this level in guinea pigs or dogs. Histopathological lesions of the liver (centrilobular granular degeneration) and increased organ weight occurred in rats exposed to 500 ppm. Although relative liver weights were slightly elevated in male rats (n = 5) exposed to 100 or 200 ppm for 2-4 hours/day (duration adjusted to 15-30 and 30-60 mg/m<sup>3</sup>, respectively), the increases were not statistically significant. A NOAEL for liver effects of 50 ppm (duration adjusted to 25.6 mg/m<sup>3</sup>) is identified in this study. Based on the PBPK model of Clewell et al. (1995b), this corresponds to a duration-adjusted NOAEL(HEC) of 162 mg/m<sup>3</sup>. These data were not amenable to benchmark analysis because standard deviations on the weight measurements were not reported.

Maltoni et al. (1980, 1981, 1984) exposed Sprague-Dawley or Wistar rats to 1 to 30,000 ppm VC for 4 hours/day, 5 days/week for 52 weeks, and mice and hamsters to 50 to 30,000 ppm VC for 30 weeks. Animals were observed throughout their lifetime (135 weeks). Tumor incidence and shortening of latency for liver angiosarcomas were concentration dependent. Additional tumor types seen in rats included liver hepatoma, nephroblastoma, neuroblastoma of the brain, Zymbal gland tumors, and mammary carcinomas. The study authors particularly noted the rarity of angiosarcoma, hepatoma, nephroblastoma, and neuroblastoma in their animal colony. The following types of tumors were observed in exposed mice: mammary, liver (including angiosarcomas), forestomach, lung, and epithelial. Tumor types in hamsters were liver (including angiosarcomas), forestomach, and epithelial. The incidence and analysis of the tumors reported in this study are presented in Section 5.3.2.

The incidence of neoplastic or potentially preneoplastic lesions, including “hepatomas, neoplastic liver nodules, nodular hyperplasia of the liver, and diffuse hyperplasia of the liver,” were also presented (Maltoni et al., 1980, 1981, 1984). Because morphological descriptions were not provided, it is not clear why different terms were used. The largest incidences were reported for diffuse hyperplasia, generally ranging from 1%-10% for males and females combined, but occurring at 20%-28% in a single experiment at 100-200 ppm. The incidence of nodular hyperplasia was about 1% in the combined controls and at  $\leq 5$  ppm and about 10%-17% or lower at higher levels. However, although lesions as well as hepatomas and neoplastic nodules were increased in the exposed groups, there was no clear concentration-response relationship for these lesions.

Other inhalation experiments support the carcinogenicity of VC. Rats and mice exposed to 0, 50, 250, or 1,000 ppm for 6 hours/day, 5 days/week for up to 6 months (mice), 10 months (rats) (Hong et al., 1981), or 12 months (mice and rats) (Lee et al., 1978) had a significantly increased incidence of hemangiosarcoma of the liver at  $\geq 250$  ppm. Animals were sacrificed 12 months after the end of exposure. Mice in this study exposed to  $\geq 250$  ppm also had an increase in bronchioloalveolar adenoma of the lung and mammary gland tumors in females (adenocarcinomas, squamous and anaplastic cell carcinomas). Male rats exposed to concentrations as low as 100 ppm for 6 hours/day, 6 days/week for 12 months and sacrificed at 18 months (6 months after the end of exposure) had significantly increased incidence of angiosarcoma of the liver (Bi et al., 1985). Rats exposed to 3% VC (30,000 ppm) for 4 hours/day, 6 days/week for 12 months had significantly increased incidences of epidermoid carcinoma of the skin, adenocarcinoma of the lungs, and osteochondroma in the bones (Viola et al., 1971), and rats exposed to 0 to 5,000 ppm for 52 weeks had primary tumors in the brain, lung, Zymbal gland, and nasal cavity (Feron and Kroes, 1979). Keplinger et al. (1975) provided a preliminary report of a concentration-dependent increase in tumor formation (alveogenic adenomas of the lung, angiosarcomas of the liver, and adenosquamous carcinoma of the mammary gland) in mice exposed to 0, 50, 200, or 2,500 ppm VC.

Suzuki (1978, 1983) investigated the effect of VC on lung tumor formation. In a preliminary study conducted with a limited number of animals, alveogenic lung tumors developed in 26 of 27 mice exposed to 2,500 or 6,000 ppm for 5-6 months (Suzuki, 1978). A concentration-related increase in the incidence of alveogenic tumors was observed in a study in which 30-40 mice/group were exposed to 1-660 ppm VC or filtered air for 4 weeks and then

observed for up to 41 weeks postexposure (Suzuki, 1983). An increase in bronchioloalveolar adenoma was observed in a lifetime study of mice exposed to 50 ppm VC for 100 1-hour exposures and 5,000 or 50,000 ppm for a single 1-hour exposure (Hehir et al., 1981). The statistical significance of these observations was not presented.

Overall, the available evidence from inhalation studies in animals supports the findings in humans that VC is a carcinogen by this route of exposure.

### **4.3. REPRODUCTIVE/DEVELOPMENTAL STUDIES—ORAL AND INHALATION**

Inhalation experiments in animals have associated developmental toxicity only with concentrations at or above those associated with maternal toxicity. In a 2 generation reproduction study done in accordance with GLP (CMA, 1998a), rats (CD, 30/sex/group) were exposed by whole body inhalation for 6 hours /day to concentration levels of 0, 10, 100 and 1100 ppm. The groups of P1 females were exposed 5 days/week beginning at 6 weeks of age for 10 weeks (prematuring exposure period), and then daily through mating and gestation. Treatment was discontinued at gestation day (GD) 20 for delivery of the F1 generation and resumed on a daily basis on lactation day 4 until sacrifice which occurred as a group after the last litter was weaned. At weaning, two F1 pups were selected randomly from each litter and exposed as the P1 parents through this postweaning period until all litters were weaned, about three weeks total. Animals were then randomly chosen from this pool of F1 animals, designated the P2 generation, and the 10 week prematuring exposure period initiated. At this period, the P2 animals were presumably near to six weeks in age as were the P1 generation at the beginning of their prematuring exposures. Daily exposures were continued through mating and gestation. Treatment was discontinued at GD20 for delivery of the F2 generation and resumed on a daily basis on lactation day 4 until sacrifice which occurred as a group after the last litters were weaned. Both generations of males were exposed in a manner parallel to the females.

Evaluation for the parental animals included body weights and food consumption. Estrous cycling was evaluated during the last three weeks of the prematuring period. Fertility and reproductive performance (pregnancy rates and male fertility indices) were recorded. Sperm assessments (motility, caudal epididymal sperm count and morphology) were performed for 15 P1 and P2 males/group. At necropsy, reproductive and other tissues (including brain, lungs, nasal turbinates[4 sections] and mammary glands) were taken from the control and 1100 ppm groups for gross and microscopic examination. The livers of all parental animals from all dose groups were examined microscopically. Pups were examined and weighed at birth and days 4, 7, 14, 21 and 25 (F1 only) during lactation. At weaning one pup/sex/litter was randomly selected, sacrificed, and given a macroscopic exam with selected tissues (including liver, ovaries and testes) weighed and preserved. The remaining pups were examined, sacrificed and discarded.

No adverse effect of treatment was seen in the parental generations including mortality, clinical findings, body weight, food consumption or effects on fertility or reproductive performance. No adverse effect of treatment was indicated in the F1 and F2 pups from survival or growth in either generation. The NOAEL for reproductive effects is > 1100 ppm.

Liver effects, including hepatocellular foci, centrilobular hypertrophy, and increased liver weights, were noted in parental (P1 and P2) animals. Liver weights were significantly increased in males only (13-20% increase over controls) in the P1 animals at 10, 100 and 1100 ppm and in P2 animals at 100 and 1100 ppm. Centrilobular hypertrophy (not hepatocyte polymorphism) was noted in a dose-related manner in P1 and P2 males at the two highest concentrations and in P1 and P2 females at all three levels of exposure. Both these effects are considered as nonadverse adaptive responses to vinyl chloride exposure (Sipes and Gandolfi, 1991).

Altered hepatocellular foci (basophilic, acidophilic and clear cell) were observed in the livers of P1 and P2 males and in P2 females. Cellular atypia was generally absent from these lesions which were also noted as usually occurring one per animal. All foci were noted as being graded at the minimum level of severity. Among P1 males exposed to 1100 ppm, only a single basophilic and a single acidophilic foci were noted among the 30 livers. Among P2 males exposed to 1100 ppm, this incidence was increased with 8 basophilic foci, 5 clear cell foci and 5 acidophilic foci noted among the 30 livers. In addition, 5 acidophilic foci were observed from among the 30 P2 livers observed at the next highest concentration of 100 ppm and one was observed from among the 30 P2 male control livers. No foci were observed among the livers of any P1 female, exposed or control. Among livers from P2 females exposed to 1100 ppm, however, 11 basophilic and 8 acidophilic foci were noted. A single basophilic foci was observed among the 30 livers from P2 females exposed at the next highest concentration of 100 ppm. No foci of any type was observed in either sex of either parental generation at the lowest exposure level of 10 ppm, the NOAEL for parental effects..

A possible explanation for the increased incidence of altered hepatocellular foci seen in the P2 vs the P1 generation is that the P2 generation was exposed throughout those periods of the life cycle (*in utero* and throughout most of the postnatal period) that are generally accepted as being of increased susceptibility to tissue injury whereas the P1 generation was not. In establishing the exposure scenario in this reproductive study, however, the P2 generation was necessarily exposed for a longer period of time, approximately 6 weeks longer if *in utero* time is considered, than was the P1 generation. Indeed, the increased incidence of liver effects in the P2 generation is more consistent with an increased dose, rather than with a period of susceptibility to vinyl chloride toxicity during which other types of effects would have the opportunity to become manifest. The increase in liver effects seen in the P2 generation relative to the P1 generation could be due to reasons other than *in utero* or juvenile susceptibility as the P2 animals were exposed not only younger than the P1 animals, but also longer and on a daily basis during the postnatal period when body weights and metabolic and respiratory functions are increasing dramatically. This confounding makes speculative any claim of neonatal or childhood susceptibility to vinyl chloride exposure for this study. However, tumor incidence has been documented to increase at maturity among laboratory animals treated with vinyl chloride during the first six months of life when compared to those exposed during the second or third six-month period of life (Maltoni et al., 1981; Drew et al. 1983; Section 4.7.1).

PBPK analysis of this reproductive study (Appendix D) indicates that the dose to the liver at 10 ppm (the NOAEL for hepatocellular foci was markedly higher than the corresponding metric derived from the NOAEL in the chronic study of Til et al. (1983). It is likely that the metric associated with the no effect 10 ppm dose level may well have been even higher if

consideration of the physiological and biochemical exposure parameters during the earlier phases of development and growth were able to be considered by the PBPK model used in this assessment. This conservative estimate of the dose metric in the liver where no effects were observed in this reproductive study is near to the metric in the chronic study of Til et al. (1983) where liver effects were observed. Thus the chronic study of Til et al. (1983) demonstrates adverse liver effects at tissue concentrations considerably lower than this reproductive study.

John et al. (1977) examined the effects of inhaled VC on the fetuses of mice, rats, and rabbits. Pregnant CF1 mice (30-40/group) were exposed to 0, 50, or 500 ppm VC on gestational days 6-15. Sprague-Dawley rats (20-35/group) and New Zealand white rabbits (15-20/group) were administered 0, 500, or 2,500 ppm VC for 7 hours/day on gestational days 6-15 for rats and 6-18 for rabbits. Parameters of maternal and developmental toxicity were evaluated; both the fetuses and litter were evaluated. Mice were more sensitive to the toxic effects of VC than either rats or rabbits. In mice, concentrations of 500 ppm induced maternal effects that included increased mortality, reduced body weight, and reduced absolute but not relative liver weight. Fetotoxicity also occurred in mice at 500 ppm and was manifested as significantly increased fetal resorption, decreased fetal body weight, reduced litter size, and retarded cranial and sternebral ossification. However, there was no evidence of a teratogenic effect in mice at either concentration. In rats exposed to 500 ppm, but not to 2,500 ppm, maternal effects were restricted to reduced body weight. Maternal effects in rats at 2,500 ppm were death of one rat, elevated absolute and relative liver weights, and reduced food consumption. A significant reduction in fetal body weight and an increase in the incidence of lumbar spurs were observed among rats exposed to 500 ppm but not 2,500 ppm and are not considered signs of VC-induced fetotoxicity. At 2,500 ppm, an increased incidence of dilated ureters was observed, which may represent a chemical-induced effect. No signs of maternal or developmental toxicity were observed in rabbits at either dose. This study identifies a NOAEL of 50 ppm for maternal toxicity and fetotoxicity in mice and a NOAEL of 2,500 ppm for rabbits.

Ungvary et al. (1978) exposed groups of pregnant CFY rats continuously to 1,500 ppm (4,000 mg/m<sup>3</sup>) on gestational days 1-9, 8-14, or 14-21 and demonstrated that VC is not teratogenic and has no embryotoxic effects when administered during the second or last third of pregnancy. During the first third of pregnancy, maternal toxicity was manifested by increased relative liver weight; increased fetal mortality and embryo toxic effects were evident. Slightly reduced body weight gain was noted in dams exposed on days 14-21.

VC does not appear to produce germinal mutations as manifested by a dominant lethal effect in male rats. In a dominant lethal study, Short et al. (1977) exposed male CD rats to 0, 50, 250, or 1,000 ppm VC for 6 hours/day, 5 days/week for 11 weeks. At the end of the exposure period, the exposed males were mated with untreated females, and there was no evidence of either preimplantation or postimplantation loss in pregnant females. However, reduced fertility was observed in male rats exposed to 250 and 1,000 ppm VC.

## **4.4. OTHER STUDIES**

### **4.4.1. Neurological**

Occupational studies of exposure to VC have reported a variety of central nervous system effects of VC, including headaches, drowsiness, dizziness, ataxia, and loss of consciousness (Lilis et al., 1975; Langauer-Lewowicka et al., 1983; Waxweiler et al., 1977). Exposure information was not available, but the reports of loss of consciousness indicate that at least periodic high exposures were involved. Central nervous system symptoms associated with VC (nausea, dizziness) were also reported in volunteers exposed to  $\geq 12,000$  ppm for 5 minutes (Lester et al., 1963). Tingling of the extremities (paresthesia), and sometimes finger numbness and pain, has also been reported. At least some of the symptoms in the extremities appear to be associated with anoxia due to vascular insufficiency; numbness of fingers and cold sensitivity are symptoms of Raynaud's phenomenon, which is associated with VC exposure (Lilis et al., 1975; Occidental Chemical Corporation, 1975). However, VC may also act directly on the peripheral nerves. Decreased nerve conduction velocities and altered electromyographic findings were also reported in VC workers, but the decreased velocities did not achieve statistical significance, and control data were not reported for the electromyographic findings (Perticoni et al., 1986). Exposure data were not reported for this study.

These occupational reports are supported by animal data. Decreased responses to external stimuli and disturbed equilibrium were observed in male Wistar rats exposed for 4 hours/day, 5 days/week for 10 months to 30,000 ppm VC (Viola, 1970). Histopathological examination at 12 months revealed diffuse degeneration of gray and white matter of the brain, including numerous atrophied nerves and pronounced cerebellar degeneration of the Purkinje cell layer. Peripheral nerve endings were surrounded and infiltrated with fibrous tissue.

### **4.4.2. Genotoxicity**

Several lines of evidence indicate that VC metabolites are genotoxic, interacting directly with DNA. In vitro genotoxicity assays indicate that VC is mutagenic in the presence of exogenous metabolic activation but not in the absence of activation. Similar assays show that the major VC metabolite, CEO, is positive in genotoxicity tests. In vivo genotoxicity tests with VC also provide evidence of genotoxicity. Finally, DNA adducts formed from VC metabolites have been identified; certain persistent adducts are believed to be associated with the development of carcinogenicity.

Several occupational studies reported genotoxic effects of VC. Sinues et al. (1991) examined the incidence of micronuclei and sister chromatid exchanges (SCEs) in a group of 52 nonsmokers exposed to VC and 41 nonsmoking controls. The exposure level was estimated at 1.3-16.7 ppm (high-exposure group) and 0.3-7.3 ppm (low-exposure group), with an average duration of 17 years. Increases in both SCEs and micronuclei were observed, and the increase correlated with exposure levels. An increase in chromosome aberrations in peripheral lymphocytes that correlated with exposure duration was observed in a cohort of 57 VC workers, compared with 19 on-site controls and 5 off-site controls. Current average exposure was 5 ppm,

but excursions up to 1,000 ppm were reported (Purchase et al., 1978). Hansteen et al. (1978) investigated chromosome aberrations in a group of VC workers exposed to 25 ppm and then again after the workers had not been exposed for 2-2.5 years. Chromosome aberrations in lymphocytes were elevated relative to controls at the initial sampling but not after exposure ceased.

VC-induced mutations were noted in the *Salmonella typhimurium* reverse mutation assay, both using vapor exposure (Bartsch et al., 1975) and incorporation into the medium (Rannug et al., 1974). The mutagenic activity was decreased or eliminated in the absence of exogenous metabolic activation. By contrast, the VC metabolites CEO and CAA increased the reversion rate even in the absence of exogenous activation (Bartsch et al., 1975; Rannug et al., 1976). The highly reactive metabolite CEO was much more potent, inducing mutations at exposures as low as 0.1 mM for 1 hour.

Single-strand breaks (SSBs) have been detected in liver DNA following inhalation exposure of mice to VC (Walles et al., 1988). (It is generally assumed that SSBs represent an intermediate stage in the excision repair of DNA adducts.) The occurrence of SSBs reached a maximum at exposures of 500 ppm, consistent with saturation of metabolism. It was found that 20% of the SSBs remained after 20 hours.

The p53 tumor suppressor gene is often mutated in a wide variety of cancers. By the use of anti-p53 antibodies, increased incidences of mutations in this gene were detected in workers occupationally exposed to VC. Even higher incidences were noted in occupationally exposed workers with angiosarcoma of the liver (Trivers et al., 1995).

The genotoxic potential of VC and its metabolites has also been investigated by assaying the formation of DNA adducts. Although 7-(2-oxoethyl)guanine (OEG) has been identified as accounting for approximately 98% of all VC adducts formed in vivo (Swenberg et al., 1992), this adduct is very rapidly repaired and does not appear to lead to miscoding during DNA replication. Therefore, it is not considered important for carcinogenesis (Laib, 1986; Swenberg et al., 1992). Instead, VC carcinogenicity is attributed to four etheno-DNA adducts that are formed at much lower concentrations than OEG but that are highly persistent (Swenberg et al., 1992) and can lead to defective transcription (Singer et al., 1987) and presumably also defective replication. For example, ethenoguanine (EG) produces a base pair mismatch (G→A transition) in bacterial assays (Cheng et al., 1991). These adducts are: 1,N<sup>2</sup>-EG; N<sup>2</sup>,3-EG; 1,N<sup>6</sup>-etheno-2'-deoxyadenosine (EDA), and 3,N<sup>4</sup>-etheno-2'-deoxycytidine (EDC) (Laib, 1986; Fedtke et al., 1990; Dosanjh et al., 1994).

It is still not possible to determine which, if any, of the DNA-adducts identified from VC exposure may be responsible for the observed carcinogenicity of VC. The likelihood that a given DNA-adduct will lead to a neoplastic transformation depends on many factors, including its persistence and the consequences of its repair or failure to be repaired. The persistence of a given adduct depends on both the rate of formation and the rate of repair (Singer, 1985); in humans, all of the etheno adducts appear to be repaired by the same DNA glycosylase but not at the same rate (Dosanjh et al., 1994). In particular, the repair of the ethenoguanines appears to be much slower than that of the other etheno-adducts in humans (Dosanjh et al., 1994). This is in contrast to the

results of a similar study in rats, where N<sup>2</sup>,3-EG was repaired with a half-life of about 30 days, while there was no evidence that EDA and EDC were repaired at all (Swenberg et al., 1992).

Recently, however, Morinello et al. (1999) reported that increases in N<sup>2</sup>,3-EG are consistent with long-term cancer bioassays in rats, with a steep slope between 0 and 100 ppm and relatively little increase at 1100 ppm. Controls averaged  $0.08 \pm 0.04$  and  $0.11 \pm 0.05$  per  $10^6$  unmodified dGua in 1 and 4 wk controls, respectively. Exposure to 10, 100, and 1100 ppm VC for 1 wk increased the N<sup>2</sup>,3-EG adducts to  $0.20 \pm 0.05$ ,  $0.68 \pm 0.09$ , and  $1.25 \pm 0.20$  per  $10^6$  dGua, respectively. After 4 wk exposure, the corresponding amounts were  $0.53 \pm 0.11$ ,  $2.28 \pm 0.18$ , and  $3.78 \pm 0.55$  N<sup>2</sup>,3-EG per  $10^6$  dGuo.

The overall evidence indicates that VC must be metabolized to cause carcinogenicity. A reactive, short-lived metabolite, which achieves only low steady-state concentrations, is thought to be responsible for the toxic effects of VC (Bolt, 1978). CEO is believed to be the ultimate carcinogenic metabolite of VC. Both CEO and CAA have been evaluated as possible carcinogenic metabolites of VC, and the overall evidence indicates that CEO is the reactive metabolite responsible for VC carcinogenicity. CEO is carcinogenic in skin and acts as an initiator in the initiation/promotion protocol, while CAA is negative in these assays (Zajdela et al., 1980). Moreover, CEO has been found to display 400-fold greater mutagenic potency than CAA in bacterial mutagenicity assays (Perrard, 1985). In a comparison of VC and 2,2'-dichlorodiethylether, which is a precursor of CAA but not CEO (Bolt, 1986), preneoplastic hepatocellular ATP-deficient foci were reported in rats following exposure to VC but not 2,2'-dichlorodiethylether (Gwinner et al., 1983). Similarly, DNA adduct formation was observed in rats dosed with VC but not with 2,2'-dichloroethylether.

In summary, although there is strong circumstantial evidence linking etheno-DNA adducts with the observed carcinogenicity of VC, there is not yet sufficient information to provide a quantitative link between the tissue concentrations of a specific adduct and the risk of cancer in that tissue. The ratio of the concentrations of the various etheno adducts in the rat is only marginally consistent across tissues and studies (Fedtke et al., 1990; Swenberg et al., 1992), and there are no data on relative adduct levels in VC-exposed humans. Amount of metabolism would still appear to provide the best dose metric for comparison with tumor incidence.

#### **4.4.3. Noncancer Mechanism**

A reactive, short-lived metabolite, which achieves only low steady-state concentrations, is thought to be responsible for the toxic effects of VC (Bolt, 1978); the rapid elimination of VC and its major metabolites is consistent with this hypothesis (Bolt et al., 1977). Both CEO and CAA can react with tissue nucleophiles, but CAA appears to be the most important source of protein adducts. The metabolism of VC to produce irreversibly bound adducts to DNA and protein was examined in vitro with rat liver microsomes (Guengerich et al., 1981). Inhibition studies were performed with alcohol dehydrogenase, which is the enzyme that catalyzes the breakdown of CAA to the corresponding alcohol, and epoxide hydrolase, which is the initial enzyme involved in the breakdown of CEO to oxalic acid. Alcohol dehydrogenase was effective in inhibiting the binding of VC metabolites to protein, while epoxide hydrolase was effective in inhibiting the



binding of VC metabolites to DNA. These results support the conclusion that the epoxide is the carcinogenic moiety, but CAA produces most of the acute toxicity.

#### **4.5. SYNTHESIS AND EVALUATION OF MAJOR NONCANCER EFFECTS AND MODE OF ACTION**

Because VC is rapidly absorbed and distributed throughout the body, oral and inhalation exposure leads to similar effects (i.e., liver) via the same modes of action (activation of parent compound within liver tissues), thus providing a rationale for performing route-to-route extrapolation.

The liver is clearly the primary target organ for cancer endpoints, as evidenced by the rare tumor type (liver angiosarcomas) occurring in both human and animal toxicity studies. The long-term repeated dose animal studies of both oral (Feron et al., 1981; Til et al., 1983, 1991) and inhalation VC exposure (Sokal et al., 1980) report a wide spectrum of liver histopathology that is considered to be neoplastic or preneoplastic in character. There is, however, liver histopathology, such as cysts and liver cell polymorphisms, reported in these studies that may be considered nonneoplastic. VC-induced liver-cell polymorphisms are very similar to the changes observed in liver parenchymal cells after administration of several pyrrolizidine alkaloids in which some cells have diameters at least 4x normal (Schoental and Magee, 1957, 1959). There has been no clear indication whether these affected cells could develop into hyperplastic nodules or hepatomas (Afzelius and Schoental, 1968). Other studies have reported increased liver weight in laboratory animals with repeated dosing (Bi et al., 1985; Sokal et al., 1980; Torkelson et al., 1961; Wisniewska-Knypl et al., 1980) and in parental animals in inhalation reproductive studies (CMA, 1998a). Occupational studies have also associated VC exposure with impaired liver function and/or biochemical or histological evidence of liver damage (Buchancova et al., 1985; Doss et al., 1984; Gedigk et al., 1975; Lilis et al., 1975; Marsteller et al., 1975; Popper and Thomas, 1975; Tamburro et al., 1984). Thus, the liver is clearly the primary target of the noncancer VC effects also. Liver toxicity is believed to be associated with the in situ production of a reactive metabolite, possibly CAA, that binds to liver proteins.

Noncancer effects of VC have also been reported in the testes, with lesions observed in two inhalation studies (Bi et al., 1985; Sokal et al., 1980). Since there is evidence of P450 activity in the testes, it is reasonable to expect that testicular effects result from a locally generated reactive metabolite. Short et al. (1986) reports male reproductive complications subsequent to inhalation exposure of VC monomer although a more complete reproductive study showed liver but no reproductive effects in either sex (CMA, 1998). Thus, the critical effect (i.e., the one that occurs first as dose increases) requires resolution, ideally through a comparison among liver, testicular, and reproductive effects.

A PBPK model as used in this assessment could allow direct comparison of various effects with common measures of dosimetry associated with those effects. The manner in which the PBPK model converts external exposures, both inhalation and oral, to common measures of dosimetry is explained in detail in Section 5.1.2 and in Appendices B and D. A concept central to the use of a common measure of dose (or common dose metric) for VC is that the toxicity of VC

is directly related to metabolism of the parent compound to a more reactive and toxic species. The PBPK model can be exercised to estimate the amount of metabolism that would occur in a specific exposure scenario with specific physiological/biochemical parameters.

The PBPK model used in this assessment (Clewell et al., 1995b) was exercised to derive two different dose metrics associated with various effects: the total amount of metabolism/body weight (termed AMET) and the total amount of metabolism in the liver/volume of the liver (RISK). This conversion of external exposures to common dose metrics is then utilized to elucidate the adverse endpoint that appears first as the exposure (and dose) increases.

#### **4.6. WEIGHT-OF-EVIDENCE EVALUATION AND CANCER CHARACTERIZATION**

Under EPA's Risk Assessment Guidelines of 1986 (U.S. EPA, 1987), VC is classified into cancer weight-of-evidence Category A. Chemicals classified into this category are considered to be known human carcinogens, based upon sufficient evidence for carcinogenicity in humans. In the case of VC, sufficient evidence in experimental animal studies provides additional support for this classification.

Under Proposed Guidelines for Carcinogen Risk Assessment (U.S. EPA, 1996), it is concluded that *VC is a known human carcinogen by both the oral and inhalation routes of exposure, but has not been tested dermally*. The weight of evidence for human carcinogenicity is based on (1) consistent epidemiologic evidence of a causal association between occupational exposure to VC and the development of angiosarcoma, an extremely rare tumor; (2) suggestive epidemiologic evidence that cancer of the brain, lung, and lymphopoietic system are associated with exposure; (3) consistent evidence of carcinogenicity in rats, mice, and hamsters via the oral and inhalation routes; (4) mutagenicity and DNA adduct formation by VC and its metabolites in numerous in vivo and in vitro test systems; and (5) efficient VC absorption via all routes of exposure, followed by rapid distribution throughout the body. Evidence has also been reported indicating increased sensitivity during early life exposure. In light of the very high percentage of angiosarcomas nationwide that are associated with VC exposure, VC is considered a strong carcinogen.

VC carcinogenicity occurs via a genotoxic pathway and is understood in some detail. VC is metabolized to a reactive metabolite, probably CEO, which is believed to be the ultimate carcinogenic metabolite of VC. The reactive metabolite then binds to DNA, forming DNA adducts that, if not repaired, ultimately lead to mutations and tumor formation. Therefore, a *linear* extrapolation was used in the dose-response assessment.

#### **4.7. SUSCEPTIBLE POPULATIONS**

##### **4.7.1. Possible Childhood Susceptibility**

In addition to the lifetime cancer studies summarized in Section 4.2, several studies of partial lifetime exposure suggest that the lifetime cancer risk depends on age at exposure, with higher lifetime risks attributable to exposures at younger ages. Drew et al. (1983) studied the

effect of age and duration of VC exposure on cancer incidence. Groups of female Fischer-344 rats, Syrian golden hamsters, B6C3F1 mice, and CD-1 Swiss mice inhaled VC at 100 ppm for durations of 6, 12, 18, or 24 months beginning after 0, 6, 12, or 18 months. (Prior to exposure, animals were 5-6 weeks old when they were received at the testing laboratory; then they were weighed and observed for 3 weeks.) VC induced angiosarcomas and mammary gland carcinomas in all four species/strains; in addition, there were hepatocellular carcinomas in rats, stomach adenomas and skin carcinomas in hamsters, and lung carcinomas in CD-1 Swiss mice. In general, cancer incidence increased with duration of exposure and decreased with age at first exposure. Tumor incidences are summarized in Tables 2 through 5.

Maltoni et al. (1981) investigated the effect of age at exposure as part of a comprehensive VC study. Groups of male and female Sprague-Dawley rats inhaled 6,000 or 10,000 ppm VC for 100 hours under different exposure schedules, three groups beginning at 13 weeks of age and one group beginning at 1 day of age (4 hours/day, 5 days/week for 5 weeks). The cancer incidence was markedly increased in rats exposed from 1 day of age. Moreover, the angiosarcoma incidence for rats exposed for 5 weeks as newborns was higher than that for rats exposed for 52 weeks beginning at 13 weeks of age. Further, hepatoma incidence, virtually nonexistent in rats exposed for 52 weeks when mature, approached 50% in rats exposed for 5 weeks as newborns. Tumor incidences are summarized in Tables 6 and 7.

Mechanistic studies are consistent with these tumor findings and suggest factors associated with early-life sensitivity. Laib et al. (1979) found that VC induces preneoplastic foci in newborn, but not mature, rats. In a subsequent study, Laib et al. (1985) studied the effect of age on induction by VC of hepatic adenosine-5'-triphosphatase (ATPase) deficient enzyme altered foci, a putative precursor of hepatocellular carcinoma. Groups of newborn male and female Wistar rats inhaled 2,000 ppm VC for different periods of time; their livers were evaluated at 4 months. The investigators concluded that "the induction of pre-neoplastic hepatocellular lesions in rats by vinyl chloride is restricted to a well defined period (approximately day 7 to 21) in the early lifetime of the animals." They attributed the lack of response in the first 5 days to the lack of hepatocellular proliferation and the low rate of VC metabolism at this stage of development.

Laib et al. (1989) found that inhaled radiolabeled VC was incorporated into physiological purines of 11-day-old Wistar rats at eightfold higher levels than in similarly treated adult rats (presumably reflecting DNA replication activity) and roughly fivefold higher levels of the DNA adduct OEG were found in the livers of young animals (reflecting an increased alkylation rate). Although OEG is not believed to be a precarcinogenic lesion, it is reasonable to expect that its levels are correlated with levels of precarcinogenic adducts. In a similar study, Fedtke et al.

**Table 2. Effects of VC on Fischer-344 rats exposed at different ages**

<b>Months exposed</b>	<b>Angio-sarcoma<sup>a</sup> incidence</b>	<b>Mammary carcinoma incidence</b>	<b>Hepato-carcinoma<sup>b</sup> incidence</b>	<b>Mean induction time<sup>c</sup></b>	<b>Mean survival time<sup>e</sup></b>
None	2/112	5/112	5/112	NR <sup>d</sup>	703
0-6	4/76	6/76	18/75	716	682
6-12	2/53	2/53	16/52	613	703
12-18	0/53	3/53	2/51	--	688
18-24	0/53	2/53	5/53	--	708
0-12	12/56	11/56	24/56	671	634
6-18	5/55	4/55	5/54	537	659
12-24	2/50	0/50	4/49	390	717
0-18	15/55	9/55	15/55	643	575
0-24	24/55	5/55	15/55	666	622

<sup>a</sup>All sites.

<sup>b</sup>Includes neoplastic nodules.

<sup>c</sup>Average time required to induce death from angiosarcomas, in days from the day each animal was first exposed.

<sup>d</sup>Not reported.

<sup>e</sup>Average lifetime in days from the day the first animals were exposed.

Source: Drew et al., 1983.

**Table 3. Effects of VC on golden Syrian hamsters exposed at different ages**

<b>Months exposed</b>	<b>Angio-sarcoma<sup>a</sup> incidence</b>	<b>Mammary carcinoma incidence</b>	<b>Stomach adenoma incidence</b>	<b>Skin carcinoma incidence</b>	<b>Mean induction time<sup>c</sup></b>	<b>Mean survival time<sup>d</sup></b>
None	0/143	0/143	5/138	0/133	--	463
0-6	13/88	28/87	23/88	2/80	NR <sup>b</sup>	390
6-12	3/53	2/52	15/53	0/49	NR <sup>b</sup>	468
12-18	0/50	0/50	6/49	0/46	--	456
18-24	0/52	1/52	0/52	0/50	--	499
0-12	4/52	31/52	3/50	2/80	NR <sup>b</sup>	355
6-18	1/44	6/44	10/44	0/38	NR <sup>b</sup>	455
12-24	0/43	0/42	3/41	0/50	--	424
0-18	2/103	47/102	20/101	3/90	NR <sup>b</sup>	342
0-24	NR <sup>b</sup>	NR <sup>b</sup>	NR <sup>b</sup>	NR <sup>b</sup>	NR <sup>b</sup>	347

<sup>a</sup>All sites.<sup>b</sup>Not reported.<sup>c</sup>Average time required to induce death from angiosarcomas, in days from the day each animal was first exposed.<sup>d</sup>Average lifetime in days from the day the first animals were exposed.

Source: Drew et al., 1983.

**Table 4. Effects of VC on B6C3F1 mice exposed at different ages**

<b>Months exposed</b>	<b>Angio-sarcoma<sup>a</sup> incidence</b>	<b>Mammary carcinoma incidence</b>	<b>Mean induction time<sup>c</sup></b>	<b>Mean survival time<sup>d</sup></b>
None	4/69	3/69	NR <sup>b</sup>	780
0-6	46/67	29/67	343	316
6-12	27/42	13/42	344	480
12-18	30/51	4/51	343	695
0-12	69/90	37/90	313	301
6-18	30/48	9/48	319	479
12-24	29/48	4/48	304	632
0-18	37/46	NR <sup>b</sup>	313	304

<sup>a</sup>All sites.

<sup>b</sup>Not reported.

<sup>c</sup>Average time required to induce death from angiosarcomas, in days from the day each animal was first exposed.

<sup>d</sup>Average lifetime in days from the day the first animals were exposed.

Source: Drew et al., 1983.

**Table 5. Effects of VC on CD-1 Swiss mice exposed at different ages**

<b>Months exposed</b>	<b>Angio-sarcoma<sup>a</sup> incidence</b>	<b>Mammary carcinoma incidence</b>	<b>Lung carcinoma incidence</b>	<b>Mean induction time<sup>b</sup></b>	<b>Mean survival time<sup>d</sup></b>
None	1/71	2/71	5/112	NR <sup>c</sup>	474
0-6	29/67	33/67	18/75	369	340
6-12	11/49	13/49	16/52	340	472
12-18	5/53	2/53	2/51	226	521
0-12	30/47	22/47	24/56	350	347
6-18	17/46	8/45	5/54	323	443
12-24	3/50	0/50	4/49	124	472
0-18	20/45	9/55	22/45	350	321

<sup>a</sup>All sites.

<sup>b</sup>Average time required to induce death from angiosarcomas, in days from the day each animal was first exposed.

<sup>c</sup>Not reported.

<sup>d</sup>Average lifetime in days from the day the first animals were exposed.

Source: Drew et al., 1983.

**Table 6. Comparison of newborn and later short-term exposure to VC**

<b>Administered concentration (ppm)</b>	<b>Angiosarcomas<sup>a</sup></b>	<b>Hepatomas</b>
4 hours/day, 5 days/week for 5 weeks starting at age 13 weeks:		
6,000	3/120	0/120
10,000	2/118	1/118
1 hour/day, 4 days/week for 25 weeks starting at age 13 weeks:		
6,000	5/118	0/118
10,000	4/119	0/119
4 hours/day, 1 day/week for 25 weeks starting at age 13 weeks:		
6,000	4/120	2/120
10,000	4/120	0/120
4 hours/day, 5 days/week for 5 weeks starting at age 1 day:		
6,000	20/42	20/42
10,000	18/44	20/44

<sup>a</sup>All sites, including angiomas.

Source: Maltoni et al., 1981 (experiments BT14 and BT10).

**Table 7. Comparison of newborn exposure and later chronic exposure to VC**

<b>Administered concentration (ppm)</b>	<b>Angio-sarcomas<sup>a</sup> in newborn rats<sup>b</sup></b>	<b>Angio-sarcomas<sup>a</sup> in mature rats<sup>c</sup></b>	<b>Hepatomas in newborn rats<sup>b</sup></b>	<b>Hepatomas in mature rats<sup>c</sup></b>
10,000	18/44	13/60	20/44	1/60
6,000	20/42	22/59	20/42	1/59

<sup>a</sup>All sites, including angiomas.

<sup>b</sup>Exposed 4 hours/day, 5 days/week for 5 weeks beginning at 1 day of age.

<sup>c</sup>Exposed 4 hours/day, 5 days/week for 52 weeks beginning at 13 weeks of age.

Source: Maltoni et al., 1981 (experiments BT14 and BT1).



(1990) observed roughly fourfold greater concentrations of both OEG and N<sup>2</sup>,3-EG in preweanling rats exposed to VC.

An increased incidence of altered hepatocellular foci was noted among mature animals that were exposed *in utero* and neonatally as compared to those that were not (CMA, 1998a). This increased incidence could have been due to exposure during these susceptible periods of the life cycle but could also have been due merely to longer overall exposure.

#### **4.7.2. Possible Gender Differences**

Human evidence is unavailable regarding possible gender differences in sensitivity to possible health effects from exposure to VC. Cohorts evaluated in epidemiology studies have been primarily male workers. Evidence from case reports is also lacking. Maltoni et al. (1981, 1984) reported no significant differences in liver cancer susceptibility in either rats or mice exposed via inhalation to VC. In feeding studies with rats, neoplastic nodules and preneoplastic alterations such as basophilic foci were induced at lower concentrations in females (Til et al., 1983, 1991). There was also some indication of increased susceptibility to induction of nonneoplastic pathological changes such as liver cysts. In this study, females had higher incidences of liver tumors than males, and the oral risk estimates were based on the female data. Based upon these limited findings, however, no definite conclusions can be made regarding possible human gender differences in susceptibility to VC.

There is some evidence for an increase in mammary tumors in female rats, suggesting the possibility of increased risk to human females. However, these tumors in rats occurred sporadically, without a positive dose-response relationship, and appear to occur in strains with a high background rate of mammary tumors. An additional threefold uncertainty factor is put forth to account for the possible induction of mammary and other nonliver tumors in the quantitative risk estimates. (See Secs. 5.3.5 and 5.3.7).

## **5. DOSE-RESPONSE ASSESSMENTS**

### **5.1. ORAL REFERENCE DOSE (RfD)**

#### **5.1.1. Choice of Principal Study and Critical Effect**

Two related chronic dietary studies of VC in rats exist (Feron et al., 1981; Til et al., 1983, 1991). Til et al. (1983, 1991) are the unpublished and published versions of the same study, conducted under the same conditions as the Feron et al. (1981) study, but at lower doses. As discussed in Section 4.2, altered hepatocellular foci observed in the Til et al. study (1983, 1991) are likely to be preneoplastic lesions produced via a genotoxic mechanism, consistent with the known mechanism of VC carcinogenicity. The Agency for Toxic Substances and Disease Registry (ATSDR, 1995) derived a chronic oral minimal risk level (MRL) based on the basophilic foci observed in the Til et al. (1983, 1991) study at the lowest administered dose tested (0.018

mg/kg-day). However, that document does not address the preneoplastic nature of this lesion, and the authors do not appear to have considered whether a preneoplastic endpoint is appropriate for the derivation of an MRL.

Based on these considerations of protocol and results, the Til et al. (1983, 1991) study was used in the derivation of the RfD. This was a well-conducted chronic dietary study with adequate numbers of rats that found an increased incidence of liver cell polymorphism and cysts at a LOAEL of 1.3 mg/kg-day and a NOAEL at 0.13 mg/kg-day. Two nonneoplastic endpoints noted at low dose levels are cysts and liver cell polymorphism. Cysts described as proliferating bile duct epithelium are not considered to be precursors of hepatocellular tumors because tumors did not develop from this location. Liver cell polymorphism was described as affecting both the nucleus and cytoplasm of the liver cells and is considered to be a toxic rather than a carcinogenic effect (Schoental and Magee, 1957, 1959; Afzelius and Schoental, 1967). All other significant findings in this study were either neoplastic or preneoplastic (see Section 4.2).

### **5.1.2. Methods of Analysis—Including Models (PBPK, BMD, etc.)**

#### **5.1.2.1. PBPK Model**

The oral RfD, inhalation RfC, oral cancer slope factor, and inhalation unit risk were all derived using a PBPK model to extrapolate animal data to humans. Therefore, general aspects of the model are described here, and aspects specific to inhalation noncancer toxicity and to carcinogenesis are described in Sections 5.2.2 and 5.3.2, respectively.

The PBPK model for VC developed by Clewell et al. (1995a) is shown in Figure 2. The model is basically an adaptation of a previously developed PBPK model for vinylidene chloride (D'Souza and Andersen, 1988). This model was also used to develop independent cancer risk estimates for VC (Clewell et al., 1995c). For a poorly soluble, volatile chemical like VC, only four tissue compartments are required: a richly perfused tissue compartment that includes all of the organs except the liver, a slowly perfused tissue compartment that includes all of the muscle and skin tissue, a fat compartment that includes all of the fatty tissues, and a liver compartment. The model also assumes flow-limited kinetics, or venous equilibration, that is, that the transport of VC between blood and tissues is fast enough for steady state to be reached within the time it is transported through the tissues in the blood.

Metabolism of VC was modeled by two saturable pathways, one high affinity, low capacity (with parameters VMAX1C and KM1) and one low affinity, high capacity (with parameters VMAX2C and KM2). Subsequent metabolism is based on the metabolic scheme shown in Figure 1: the reactive metabolites (whether CEO, CAA, or other intermediates) may then either be metabolized further, leading to CO<sub>2</sub>, react with GSH, or react with other cellular materials, including DNA. Because exposure to VC has been shown to deplete circulating levels of GSH, a simple description of GSH kinetics was also included in the model.

The model is capable of route-to-route extrapolation, as either oral and inhalation exposures may be entered and common dose metrics calculated either at the liver or in the whole

body. The model is also capable of interspecies extrapolation because it is parameterized for humans and several different rodent species such that common dose metrics can be calculated for any of these species. Conversion of various oral, intermittent animal, and intermittent human exposures to a continuous human exposure concentration (i.e., an HEC) is accomplished by comparing the common dose metrics to those obtained

from running the model with human parameters under continuous exposure conditions. For example, a specific mg/kg-day dose from an animal feeding study can be converted by the animal-parameterized model to a dose metric at the liver in terms of mg metabolites/volume of liver. This dose metric can be compared with those calculated from the human-parameterized model (also in terms of mg metabolites/volume of liver) run under conditions of a continuous inhalation exposure to obtain a human dose that would correspond to the specific dose of an animal feeding study.

A complete description of the model, including the rationale for parameter choices in animals and humans, choice of dose metric, and experimental information used to validate and optimize the model, is in Appendix B. It is noted here and elsewhere in this document (Section 6 and Appendices B and D) that the inhalation portion of this model is well documented, with experimental inhalation data for optimization and validation sufficient to impart a relatively high degree of confidence in dose metrics derived from inhalation scenarios. Dose metrics derived from oral scenarios do not have nearly the amount of data necessary to impart an equivalent level of confidence. To compensate for this uncertainty, procedures have been instituted in the oral exposure input to ensure that estimates of oral dose metrics would be “worst case” and conservative.

Based on the analysis in Section 4.5, the liver toxicity endpoints in the Feron et al. (1981) and Til et al. (1983, 1991) studies were considered appropriate for the derivation of the RfD. As discussed in Section 4.4, the noncancer effects are believed to be due to reactive metabolites, possibly CAA. The most appropriate pharmacokinetic dose metric for a reactive metabolite is the total amount of the metabolite generated divided by the volume of the tissue into which it is produced (Andersen et al., 1987) and is designated “RISK” in the output of the PBPK model. For liver toxicity/carcinogenicity, all metabolism was assumed to occur in the liver, while testicular toxicity was assumed to be due to metabolism that occurred in the testes. The dose metric chosen for the testes is the total amount of the metabolite generated (scaled across species based on body weight) divided by body weight and is designated “AMET” in the output of the model.

Reitz et al. (1996) developed a similar PBPK model, with a description of parent chemical kinetics and total metabolism based on the styrene model of Ramsey and Andersen (1984). Metabolism of VC was modeled with a single saturable pathway, and the kinetic constants were estimated from fitting of closed chamber gas uptake data with rats. The structure of the parent chemical portion of the Reitz et al. (1996) and Clewell et al. (1995a) models is essentially identical; only the descriptions of metabolism in the two models differ substantially. As discussed above, the model of Clewell et al. (1995a) includes a more complex description of metabolism, with two saturable oxidative pathways rather than one, and with a description of GSH

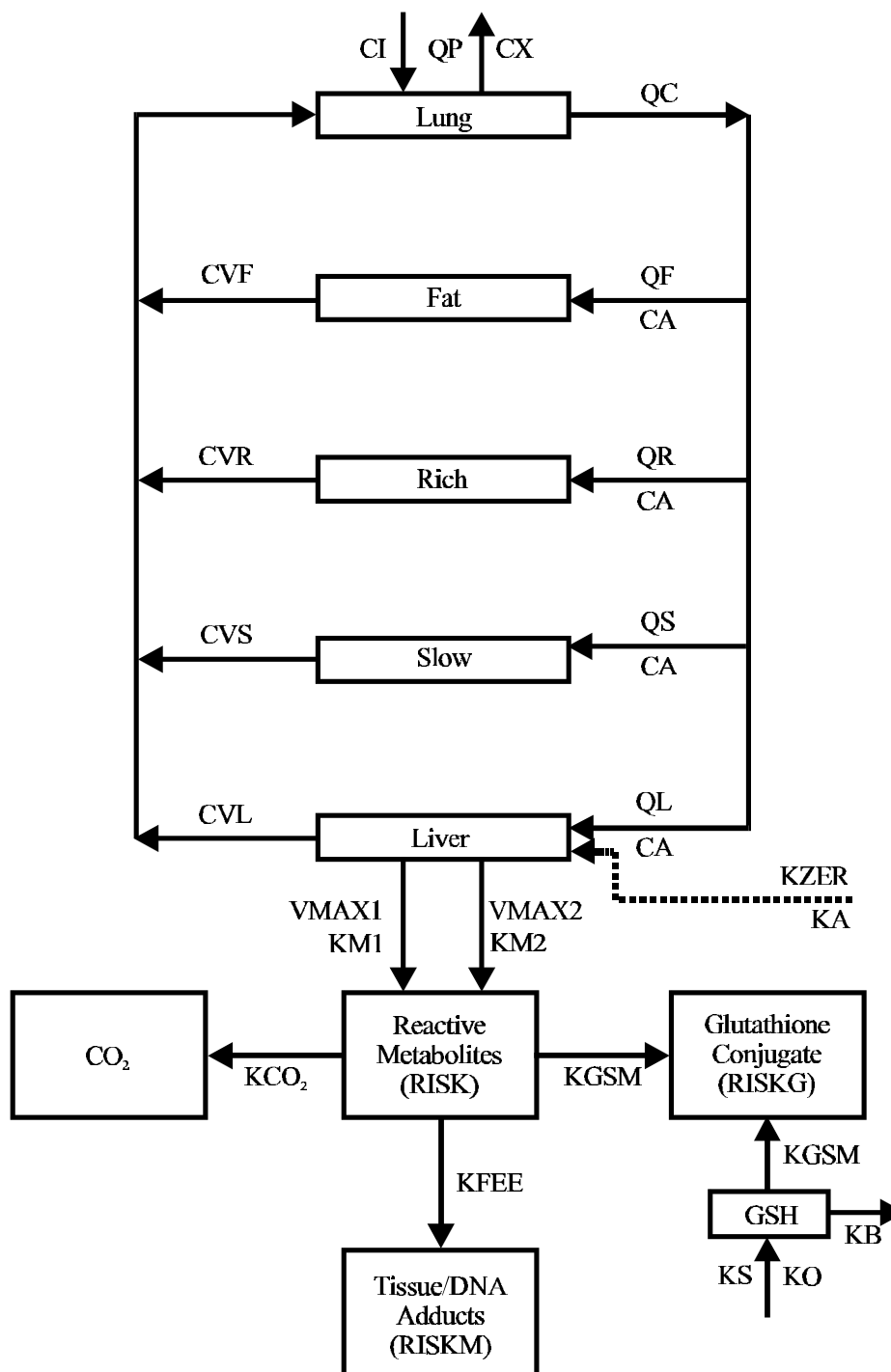

conjugation of the oxidative metabolites. Nevertheless, dose metrics calculated on a

**Figure 2. The PBPK model for vinyl chloride developed by Clewell et al. (1995a).**

common set of data using the two models are in close agreement, as demonstrated in Appendix A.

For the noncancer oral and inhalation assessments for VC, dose metrics were calculated for liver cell polymorphisms reported in the chronic rat dietary study of Til et al. (1983, 1991) (Appendix C-1). In order to convert these dose metrics to the human equivalent dose, a human dose metric was generated from a sample continuous human exposure scenario where stimulation of ingestion of 1 ppm in water (0.028 mg/kg-day assuming 2 L/day/70 kg person) yielded a human dose metric of 0.581 mg/L liver. Because VC metabolism is linear in this dose range, the ratio of the intake and dose metric provides a factor ( $0.028/0.581 = 20.31$ ) for converting from male and female rats at the NOAEL ( $[3.03 + 2.96] \div [2 \times 20.31]$ ) to obtain the NOAEL(HEC) = 0.15 mg/kg-day. The corresponding LOAEL(HEC) is 1.5 mg/kg-day ( $[30.2 + 29.4] \div [2 \times 20.31]$ ).

#### **5.1.2.2. BMD Calculation**

The same dose metric (mg metabolite/L liver) was calculated for the dose groups (males and females combined) and the benchmark analysis performed on this metric and the incidence of liver cell polymorphism (males and females combined) reported in the Til et al. (1983, 1991) study. The analysis shows data limitations (only one nonzero datapoint in the dataset and wide dose-spacings) and wide variability in the responses from the various models. As a consequence, the benchmark analysis was not used for quantitation in this assessment.

#### **5.1.3. RfD Derivation**

The NOAEL for liver cell polymorphism in the Til et al. (1983, 1991) study is 0.13 mg/kg-day, and the LOAEL is 1.3 mg/kg-day. Using the PBPK model of Clewell et al. (1995a,b), the corresponding human NOAEL and LOAEL are 0.15 and 1.5 mg/kg-day, respectively. These values are very close to, but slightly higher than, the animal doses.

An uncertainty factor of 10 was used for protection of sensitive human subpopulations and 3 for animal to human extrapolation. The uncertainty factor for intraspecies variability includes the variability in risk estimates that would be predicted by the model for different individuals due to variability in physiology, level of activity, and metabolic capability. A factor of 3 was used for interspecies extrapolation because, although PBPK modeling refines the animal to human comparison of delivered dose, it does not address the uncertainty regarding the toxicodynamic portion of interspecies extrapolation (relating to tissue sensitivity). Although there is relative uncertainty in this assessment with regards to the derivation of the dose metrics from oral settings, it is offset by the conservative manner in which these metrics were derived, and no extra uncertainty factors are considered necessary.

No modifying factor is proposed for this assessment. While testicular effects were reported in a study by Bi et al. (1985), the effects occurred at exposure levels that would result in

a considerably greater RfD. Developmental and other effects were noted only at high concentrations. Based on these considerations, the following RfD was derived:

$$\text{RfD} = 0.15 \text{ mg/kg-day} \div 30 = 0.005 \text{ mg/kg-day} = 5\text{E-}3 \text{ mg/kg-day.}$$

## 5.2. INHALATION REFERENCE CONCENTRATION (RfC)

### 5.2.1. Choice of Principal Study and Critical Effect

The RfC is based on liver cell polymorphism and cysts observed in the chronic dietary rat study of Til et al. (1983, 1991). Several lines of reasoning justify this choice. The NOAEL(HEC) from the Til et al. (1983, 1991) study was calculated (see discussion of PBPK model below) and in Appendix D) at 4.4 mg/m<sup>3</sup>. This concentration is far lower than the LOAEL(HEC) of the transient increase in liver weight observed in the study of Bi et al. (1985) at 47.8 mg/m<sup>3</sup>, indicating that liver cell polymorphism was the more sensitive endpoint. More detailed analysis of data in the Bi et al. (1985) study is not possible, because the study authors reported only the data for those changes that were considered significant, and body weight data were not reported. In addition, the power to detect an effect at 12 months was limited by the small number of animals sacrificed (n = 6), compared with the 30 animals sacrificed at 6 months. The NOAEL(HEC) for liver effects in the 10-month inhalation study of Sokal et al. (1980) was calculated at 162 mg/m<sup>3</sup> and a NOAEL(HEC) for testicular effects considerably higher at 252 mg/m<sup>3</sup>. A NOAEL(HEC) of 162 mg/m<sup>3</sup> based on liver effects was also estimated for the 6-month inhalation study of Torkelson et al. (1961). An RfC possibly could be derived from among these inhalation studies which, with the application of sufficient uncertainty factors, could be made quantitatively comparable to that derived with the Til study. However, the experimental strengths of the Til study relative to the inhalation studies, including, in addition to the the lifetime exposure, large group sizes and extensive reporting of results, clearly give a qualitative advantage to the the Til study that would be reflected not only in lower uncertainty but concomitantly in higher confidence. Although the attributes of the Til study are offset somewhat by the uncertainty associated with derivation of the oral dose metrics (Appendix B), it is still judged to be the most valid choice for the principal study.

ATSDR (1995) based an intermediate duration inhalation MRL on increased relative liver, heart, and spleen weights in the Bi et al. (1985) study. Because a pharmacokinetic model was not used, the oral studies of Feron et al. (1981) and Til et al. (1983, 1991) were not an option for ATSDR. Interpretation of the organ weight data in the Bi et al. (1985) study is complicated by the fact that the study did not report absolute organ weights, relative weights for groups with no significant differences, standard deviations, or histopathology results (except in the testes).

Other endpoints in these and other studies occurred at higher exposure levels and thus were not considered as appropriate for the critical effect as in the liver. These endpoints included increased incidence of damage to the testicular seminiferous tubules in rats (Bi et al., 1985), increased liver weight and liver lesions (Sokal et al., 1980), increased damage of spermatogenic epithelium (Sokal et al., 1980), increased liver weight (Torkelson et al., 1961; Wisniewska-Knypl et al., 1980), and lipid accumulation (Wisniewska-Knypl et al., 1980).

## 5.2.2. Methods of Analysis—Including Models (PBPK, BMC, etc.)

### *Route-to-Route Extrapolation*

Deriving an inhalation RfC from an oral study requires route-to-route extrapolation.

extrapolation as adequate toxicity data exist from one route (oral), and the observed toxicity is observed in the liver, remote from the portal of entry. The concurrence of liver as the target

development of several PBPK models specific for VC make this chemical an even more compelling candidate for this extrapolation procedure.

### *PBPK Model*

The PBPK model described in Section 5.1.2 was used to extrapolate inhalation (metabolite/L liver) that was common for both the oral and inhalation routes of exposure. As information validating the model for this route of exposure was limited (Appendix B), served to maximize the formation of the reactive species. This same metric served as a basis to calculate HECs such that the overall transformation of data was from mg/kg-day oral intake in

The following procedure was employed in the route-to-route extrapolation with the chronic oral study of Til et al. (1983, 1991). The dose metric for the animal NOAEL was exposed to 0.13 mg/kg-day. This metric was calculated to be 3.00 mg/L liver (from the average of the male value of 3.03 and the female value of 2.96). The PBPK model was then exercised to range of exposure concentrations ( $1 \mu\text{m}^3$  <sup>3</sup>) showed that the relationship with the <sup>3</sup> with the factor in the linear range being 0.68 mg/L <sup>3</sup> VC. This factor was then used to convert this metric to a continuous human <sup>3</sup> was then accomplished by arrive at a NOAEL(HEC) of  $4.4 \text{ mg/m}^3$  ( $29.9/0.68$ ) or  $43.9 \text{ mg/m}^3$

### 5.2.2.3. BMC Calculation

from the PBPK model for liver cell polymorphism and cysts reported in the chronic rat dietary study of Til et al. (1983, 1991). The same dose metric (mg metabolite/L liver) was calculated for and the incidence of liver cell polymorphism (males and females combined) reported by Til et al.

(1983, 1991). The analysis shows data limitations (only one nonzero datapoint in the dataset and wide dose-spacings) and wide variability in the responses from the various models. As a consequence, the benchmark analysis was not used for quantitation in this assessment.

Even though benchmark dose/concentration was not appropriate for the analysis of the critical effects in Til et al. (1983, 1991), BMCs calculated for the other inhalation studies were shown to be considerably higher than for the liver polymorphism endpoint. BMC(HEC) values corresponding to a benchmark response (BMR) of 10% extra risk were 316 mg/m<sup>3</sup> for damage to the testicular seminiferous tubules in rats (Bi et al., 1985); 102 mg/m<sup>3</sup> for polymorphism of hepatocytes in the 10-month inhalation study of Sokal et al. (1980); 160 mg/m<sup>3</sup> for proliferation of reticuloendothelial cells, although these may be preneoplastic (Sokal et al., 1980); and 212 mg/m<sup>3</sup> for damage to the spermatogenic epithelium (Sokal et al., 1980). Proliferation of reticuloendothelial cells, however, may be preneoplastic. The only continuous endpoint that could be modeled was increased liver weight in the studies by Sokal et al. (1980) and Wisniewska-Knypl et al. (1980), which reported the same data. The most sensitive BMC(HEC) for this endpoint (293 mg/m<sup>3</sup>) was obtained with the BMR defined as a change in the mean of  $sd_v/2$ , using the polynomial model<sup>3</sup>. The increased relative liver weight observed by Torkelson et al. (1961) could not be modeled, but the NOAEL(HEC) based on the tissue dose was 162 mg/m<sup>3</sup>. Similarly, the LOAEL(HEC) for lipid accumulation (Wisniewska-Knypl et al., 1980) was 137 mg/m<sup>3</sup>.

The rationale for choice of the critical effect and principal study for the RfC is the same used for the oral RfD, i.e., the analysis in Section 4.5. The NOAEL(HEC) derived using the internal dose metric for liver cell polymorphism and cysts from the oral feeding study of Til et al., 1983, 1991) was 4.4 mg/m<sup>3</sup>. Section 4.5 demonstrated that NOAEL/LOAELs of other noncancer effects in both oral and inhalation studies were higher than those noted for the incidence of liver cell polymorphisms and hepatic cysts.

As for the RfD, an uncertainty factor of 10 was used for protection of sensitive human subpopulations and 3 for animal to human extrapolation. The uncertainty factor for intraspecies variability includes the variability in risk estimates that would be predicted by the model for different individuals due to variability in physiology, level of activity, and metabolic capability. A factor of 3 was used for interspecies extrapolation because, although PBPK modeling refines the animal to human comparison of delivered dose, it does not address the uncertainty regarding the toxicodynamic portion of interspecies extrapolation (relating to tissue sensitivity). Although there is relative uncertainty in this assessment with regards to the derivation of the dose metrics from oral settings, it is offset by the conservative manner in which these metrics were derived, and no uncertainty factors are considered necessary.

No modifying factor is proposed for this assessment because the quality of the critical study was high, and because effects measured at organs other than the liver occurred only at considerably greater exposure levels. Based on these considerations, the following RfC was derived:

$$\text{RfC} = 4.4 \text{ mg/m}^3 \div 30 = 1\text{E-}1 \text{ mg/m}^3.$$



### 5.3. CANCER ASSESSMENT

As discussed in Section 4.6, VC is considered to be *a known human carcinogen by the oral and inhalation route, but has not been tested by the dermal route*. The weight of evidence is based upon (1) consistent epidemiologic evidence of a causal association between occupational exposure to VC and development of angiosarcoma; (2) suggestive epidemiologic evidence that cancers in the brain, lung, connective tissue, and lymphopoietic system are associated with exposure; (3) consistent evidence of carcinogenicity in rats, mice, and hamsters via the oral and inhalation routes; (4) mutagenicity and DNA adduct formation by VC and its metabolites in numerous in vivo and in vitro test systems; and (5) efficient VC absorption via all routes of exposure tested, followed by rapid distribution throughout the body.

#### 5.3.1. Choice of Study/Data With Rationale and Justification

##### 5.3.1.1. Human Data

As discussed in Section 4.1, numerous human studies have documented the association between occupational exposure to VC and the development of angiosarcomas and other cancers. Three of these studies were used to develop dose-response assessments (Fox and Collier, 1977; Jones et al., 1988; and Simonato et al., 1991). Because exposure was not adequately characterized in these studies, recommended potency estimates were based on animal bioassay data. The cancer potency estimates derived from these studies do, however, provide support for the recommended values. The most detailed exposure information was provided by Fox and Collier (1977). In this study only 4 deaths due to liver cancer, 2 of which were angiosarcoma, were recorded. In the Jones et al. study, an update of Fox and Collier, adequate exposure data was available only for autoclave workers for which 7 liver angiosarcoma deaths were recorded. The Simonato et al. (1991) study has the largest cohort and the most liver deaths (24), but less accurate exposure information, because data was collected from several different workplaces, and because of possible misclassification of workers. The PBPK model of Clewell et al. (1995a) was used to calculate a cumulative internal dose metric. Because VC metabolism begins to be nonlinear at the high exposure levels in these studies, cumulative exposure (e.g., ppm-years) was not sufficient for a quantitative assessment. Instead, only data sets providing information on both exposure level and duration (or cumulative exposure, from which duration could be estimated) were considered appropriate for modeling. Risk estimates (95% upper bound) derived using these three studies ranged from  $1.6 \times 10^{-7}$  to  $1.6 \times 10^{-6}$  per  $\mu\text{g}/\text{m}^3$  VC. An earlier estimate by Chen and Blancato (1989), based on the results of Fox and Collier (1977) was also within this range. (See appendix B for details). In addition to providing support for animal data based potency estimates, epidemiologic data also provide some assurance that any additional risk from tumor induction at sites other than the liver are likely to be modest. For example, while incidences of brain, connective and other soft tissue cancers were reported to be significantly increased in a recent CMA (1998b) study, the excess deaths from these cancers were estimated to less than one third that of liver cancer. Because there is no information on possible breast cancer induction, a target site in some of the animal bioassays, however, some uncertainty still remains.

### 5.3.1.2.

Three studies were located that provided data on the oral carcinogenicity of VC. The oral cancer assessment was based on a well-conducted study by Feron et al. (1981) in which rats were

measured to ascertain actual intake of VC. A related dietary study was conducted at lower doses (Til et al., 1983, 1991), but this study did not provide adequate dose-response information, since

carcinogenicity study of VC administered by oil gavage to male and female rats. The data from this oil gavage study were not considered appropriate as the basis for a risk assessment.

same doses administered in an aqueous suspension (Bull et al., 1986). Corn oil has also been shown to increase peroxisomal oxidative enzyme activity in rats (DeAngelo et al., 1989);

promotional environment created in the liver by continual dosing with large volumes of vegetable oil could potentiate the effects of genotoxic carcinogens in the liver. For this reason, the single

assessment. Finally, the PK model does not predict accurately the metabolism of VC administered in very large bolus doses.

exposure were provided by Maltoni et al. (1981), Drew et al. (1983), and Laib et al. (1985). Since these studies are inadequate to develop dose-response estimates, recommended estimates

Maltoni et al. (1981,1984). The former studies, however, did provide sufficient evidence for recommending a two-fold adjustment of risk for to account for early life exposure. For details see

Molecular toxicology data suggest that the VC-induced liver angiosarcomas and suppressor gene in mice results in the spontaneous development of angiosarcoma, along with malignant lymphoma, but not hepatocellular carcinoma (Donehower et al., 1992). In contrast, of the *myc* *ras* oncogenes (Sandgren et al., 1989) but not with mutational loss of p53 function occur via a p53-independent mechanism, more likely related to *myc* *ras*, while the

Chemically induced human liver carcinogenicity is associated with mutational alteration of multiple genes, consistent with a mutagenic mode of action. Mutations in the p53 tumor

associated with aflatoxin-induced human hepatocellular carcinoma (Greenblatt et al., 1994). *Ras*

human angiosarcoma is associated with frequent mutation of *ras*

1994). In fact, the presence of both mutant *ras*

value of 0.67 for liver tumors in humans (Marion et al., 1996). On the basis of these studies, it

has been suggested that chemicals that act through a p53-dependent process are more likely to be trans-species carcinogens than those that act through a p53-independent process such as *ras* activation (Tennant et al., 1995; Goldsworthy et al., 1994). As noted above, however, both p53 and *ras* mechanisms appear to be implicated in human liver cancers.

According to EPA's Guidelines for Carcinogen Risk Assessment (U.S. EPA, 1986), when significant increases in tumor induction occur at more than one site, the animals with tumors at all such sites are included in the total, unless mechanistic data are sufficient to discount them. Although hepatocellular tumors may occur via a mechanism less relevant to humans (p53 independent), present knowledge is insufficient to rule out their use for human risk assessment. Moreover, even though the majority of liver tumors reported in VC-exposed workers were angiosarcomas, some hepatocellular tumors, also a rare tumor type in humans, were usually noted (Wong et al., 1991; CMA 1998b). Finally, combining tumor types decreases the likelihood of underestimating risk in humans. This is especially important in the case of VC since suggestive evidence for brain tumors and lymphomas was noted in at least some of the epidemiology studies. Cancer unit risk estimates were therefore based upon animals with either liver angiosarcomas, hepatocellular carcinomas, or liver neoplastic nodules. Neoplastic nodules were included because they are considered equivalent to adenomas and also because it is considered likely that they will progress to carcinoma if survival duration is sufficient. Although lung angiosarcomas were also increased significantly in the Feron et al. (1981) study, they are considered to be metastatic because, with the exception of one high-dose male rat, all animals with lung angiosarcomas also had liver tumors and were therefore included in the counts.

Several animal studies investigated the carcinogenicity of VC via the inhalation route. Maltoni et al. (1984) conducted the most thorough analysis, in which male and female mice and rats were exposed to a wide range of VC concentrations for 30 weeks (mice) or 1 year (rats) and then followed through 135 weeks after the initiation of exposure. Other studies did not characterize the concentration-response curve as well (Bi et al., 1985; Hong et al., 1981; Keplinger et al., 1975; Lee et al., 1978) or did not observe angiosarcomas (Feron and Kroes, 1979; Viola et al., 1971). For a review of recent results of human and animal exposures to VC, mechanistic data, DNA reactivity, and attempts at cross-species extrapolation of cancer risk see Whysner et al. (1996).

In accordance with the Proposed Guidelines for Carcinogen Risk Assessment (U.S. EPA, 1996), the potential for using preneoplastic endpoints as a basis for the cancer assessment was evaluated. Two potential preneoplastic changes were considered: altered hepatocellular foci (i.e., clear cell foci, basophilic foci, and eosinophilic foci [Feron et al., 1981; Til et al., 1983, 1991]) and DNA adducts (Swenberg et al., 1992; Morinello et al., 1999). The altered hepatocellular foci might be used to extend the tumor dose-response curve to lower doses, reducing the amount of extrapolation necessary to reach the exposure levels of interest. In order to conduct such an extrapolation, it would be necessary to determine a correspondence factor between the incidence of foci and the tumor incidence in the portion of the dose-response curve where both foci and tumors are observed. No attempt was made to conduct such a calculation, however, because the observed foci are precursors to hepatocellular carcinoma, while angiosarcomas, the tumor type of greatest relevance to human risk assessment, are derived from sinusoidal cells. Proliferation of sinusoidal cells was also observed in these studies, but the incidence did not achieve statistical

significance, and any increased response did not extend to doses below those at which angiosarcomas were observed.

As discussed in Section 4.4, VC exposure results in the formation of DNA adducts, and four highly persistent ethenoguanine-DNA adducts have been associated with VC carcinogenicity (Swenberg et al., 1992). More recently Morinello et al. (1999) reported a steep dose-response for N<sup>2</sup>,3-ethenoguanine adducts at low VC exposure concentrations, with a leveling off at higher concentrations, a response consistent with both metabolic activation rates and tumor induction. Adduct levels normally cannot be used directly to extend tumor dose-response data to lower doses, since tumor formation from adducts depends on many factors, including the consequences of adduct repair or failure to be repaired. Thus, although a quantitative analysis of the relationship between VC metabolism, adduct formation, and tumor formation is likely to be a fruitful area for additional research, it is premature to attempt to establish a quantitative link between the tissue concentrations of a specific adduct and the risk of cancer in that tissue.

### 5.3.2. Dose-Response Data

Oral cancer risk was calculated based on the incidence of combined liver angiosarcomas, hepatocellular carcinomas, and neoplastic nodules in female Wistar rats in the dietary study of Feron et al. (1981). The administered doses and tumor incidences were as follows:

<b>Administered dose (mg/kg-day)</b>	<b>Tumor incidence, female rats</b>
0	2/57
1.7	28/58
5.0	49/59
14.1	56/57

Inhalation cancer risk was calculated based on the incidence of liver angiosarcoma, angioma, hepatoma, or neoplastic nodules in the inhalation study of Maltoni et al. (1981, 1984), conducted with male and female Sprague-Dawley rats and male and female CD-1 Swiss mice. The incidence in the rats was as follows:

Exposure concentration (ppm)	Tumor incidence <sup>a</sup>	
	Males	Females
0	0/108	0/141
1	0/48	0/55
5	0/43	0/47
10	0/42	1/46
25	1/41	5/40
50	0/26	1/29
100	1/37	1/43
150	2/36	5/46
200	12/42	10/44
250	2/28	3/26
500	1/22	11/28
2,500	6/26	10/24
6,000	4/17	13/25

<sup>a</sup>Animal numbers were adjusted to include those surviving until detection of the first liver tumor.

The tumor incidence in the mice in the Maltoni et al. (1981, 1984) study was as follows:

Exposure concentration (ppm)	Tumor incidence <sup>a</sup>	
	Males	Females
0	1/65	0/62
50	3/20	1/27
250		12/23
500	7/21	12/28
2,500	12/14	13/26
6,000		2/19
10,000	1/12	14/25

<sup>a</sup>Animal numbers were adjusted to include those surviving until detection of the first liver tumor.

### 5.3.3. Dose Conversion

Due to the use of the PBPK model for animal to human extrapolation, doses were not converted to human equivalents prior to the calculation of risk. Instead, the risk modeling (linearized multistage [LMS] or the dose associated with a lifetime cancer risk of 10% [ED10]) was conducted based on the animal dose metric of the daily amount of metabolite generated, divided by the volume of the tissue in which the metabolite is produced (Andersen et al., 1987).

Then, consistent with the statement that “. . . tissues experiencing equal average concentrations of the carcinogenic moiety over a full lifetime should be presumed to have equal lifetime cancer risk” (U.S. EPA, 1992), the calculated risk values based on the dose metric were assumed to correspond to the same risk for the same human dose metric. In order to convert the human dose metric to a human dose, the model was run for a sample human continuous oral exposure (1 mg/L in drinking water) to determine the dose of metabolites to the human liver corresponding to a given ingested dose. Since VC metabolism is linear in the human in the dose range of interest, this equivalence factor could be used to convert the risk based on the dose metric (now in humans) into the human oral dose. Similarly, the equivalence factor for inhalation exposure was calculated by determining the human dose metric for continuous human inhalation exposure to a range of exposure concentrations (1  $\mu\text{g}/\text{m}^3$  to 10,000  $\text{mg}/\text{m}^3$ ). This calculation showed that the model was linear up to nearly 100  $\text{mg}/\text{m}^3$ , and the calculated equivalence factor was used to convert the risk from the inhalation experiments conducted in animals (in the units of the dose metric) to human risk values.

Because of the use of the PBPK model an additional scaling factor i.e.( $\text{bw}^{3/4}$ ) has not been adopted. Adoption of a scaling factor as a default method is based upon the assumption that a direct acting agent is detoxified more rapidly by mammals with smaller body weights, due to their faster metabolic rate compared with larger ones. Therefore, the steady state concentration of the active metabolite at the target site is predicted to be lower at a given rate of intake than in humans. In the case of vinyl chloride, concentration at the target site is more closely related to factors such as metabolic activation, blood-to-air partition coefficients etc., which are accounted for by use of the PBPK model. In fact, detoxification rates of VC metabolites are not considered to vary significantly among species because the metabolites react rapidly with cellular macromolecules including DNA, and in any case liver glutathione (GSH) concentration is similar in rats and humans. Since steady state concentration of the active metabolite is estimated by application of the PBPK model, application of a scaling factor as well, is predicted to result in an overly conservative estimate of human risk. The low cancer risk estimates based on human epidemiology data, although having considerable uncertainty, nevertheless provide support for not applying a body surface area correction.

#### **5.3.4. Extrapolation Method(s)**

Two methods were used to extrapolate to low doses. In accordance with the Proposed Guidelines for Carcinogen Risk Assessment (U.S. EPA, 1996), the ED 10/linear method was one of the methods employed. This method draws a straight line between the point of departure from the observed data, generally the  $\text{LED}_{10}$  (the lower 95% limit on a dose that is estimated to cause a 10% response) and the xy axis. The second extrapolation method used was the linearized multistage model (extra risk), in accordance with the current risk assessment guidelines (U.S. EPA, 1987). Linear extrapolation is the appropriate methodology for VC, a chemical known to act via a genotoxic mechanism.

### 5.3.5. Oral Slope Factor and Inhalation Unit Risk

The oral slope factor and inhalation unit risk calculated for VC are presented in Table 8 (LMS model) and Table 9 (95% lower bound on the ED10). The values calculated using these two methods were very similar. Two uncertainty factors have been put forth: a threefold uncertainty factor to account for possible induction of tumors at sites other than the liver and a twofold adjustment to account for early life exposure. The basis for their application is discussed below. After making these adjustments to the risk estimates derived using the LMS procedure, the oral slope factor is 2.5 per (mg/kg)/day and the average inhalation unit risk is  $8.7 \times 10^{-6}$  per  $\mu\text{g}/\text{m}^3$ .

**Table 8. Lifetime human cancer risk estimates based on incidence of liver tumors in animal bioassays with extrapolation using the LMS model**

<b>Study</b>	<b>Sex</b>	<b>Inhalation risk<sup>a</sup> (per <math>\mu\text{g}/\text{m}^3</math>)</b>	<b>Oral slope factor<sup>a</sup> (mg/kg-day)<sup>1</sup></b>
Rats, dietary (Feron et al., 1981)	F		$2.5 \times 10^0$
Mice, inhalation (Maltoni et al., 1981, 1984, BT4)	M	$8.8 \times 10^{-6}$	
	F	$7.4 \times 10^{-6}$	
Rats, inhalation (Maltoni et al., 1981, 1984, BT1, BT2, and BT15)	M	$3.4 \times 10^{-6}$	
	F	$1.5 \times 10^{-5}$	
<b>Average inhalation</b>		$8.7 \times 10^{-6}$	

<sup>a</sup>Includes a sixfold factor to account for lifetime exposure from infancy, and possibility of tumor induction at nonliver sites. If exposure is limited to adulthood, the risk is decreased twofold.

**Table 9. Lifetime human cancer risk estimates based on incidence of liver tumors in animal bioassays with extrapolation using the ED10/linear method**

<b>Study</b>	<b>Sex</b>	<b>Inhalation risk<sup>a</sup> (per <math>\mu\text{g}/\text{m}^3</math>)</b>	<b>Oral slope factor<sup>a</sup> (<math>\text{mg}/\text{kg}\text{-day}</math>)<sup>-1</sup></b>
Rats, dietary (Feron et al., 1981)	F		$2.6 \times 10^0$
Mice, inhalation (Maltoni et al., 1981, 1984, BT4)	M	$8.3 \times 10^{-6}$	
	F	$9.5 \times 10^{-6}$	
Rats, inhalation (Maltoni et al., 1981, 1984, BT1, BT2, and BT15)	M	$3.2 \times 10^{-6}$	
	F	$1.4 \times 10^{-5}$	
Average inhalation		$8.8 \times 10^{-6}$	

<sup>a</sup> Includes a sixfold factor to account for lifetime exposure from infancy, and possibility of tumor induction at nonliver sites. If exposure is limited to adulthood, the risk is decreased twofold.

**5.3.5.1. Basis for Recommending a Three-fold Uncertainty Factor to Account for Tumors at Sites Other Than the Liver.**

A recommended threefold uncertainty factor to account for possible induction of nonliver tumors is based on limited evidence for induction of tumors at other sites such as the mammary gland and kidneys in rats, as well as brain, soft tissue and connective tissue in humans. Estimation of possible increased risk from nonliver sites may be approached in various ways. One approach is to include animals with tumors in other organs such as kidneys and mammary tissue, as well as liver, in the data sets used to calculate dose-response. According to EPA Cancer Risk Assessment Guidelines, however, it is recommended that animals with tumors be summed only for those sites where statistically significant increases in tumors are noted. This approach was not used because increased tumor incidences in organs other than the liver were very sporadic and generally not statistically significant in the data sets suitable for quantitation. Moreover, individual animal data was not available for the Maltoni et al. (1981,1984) studies that were used to estimate cancer potency via inhalation. This raises the possibility of counting animals with tumors at two or more sites more than once, introducing inaccuracies in the dose-response assessment. Another approach is to calculate risk for each site separately and then add risks together. This approach was not adopted for the similar reasons.

Despite the limitations of the data, the possibility of additional risk due to tumor induction at nonliver sites deserves consideration. To accommodate the possibility of increased risk from nonliver tumors, potency estimates based on the induction of either kidney or mammary tumors were derived, even though the incidence of these tumors were quite sporadic. Since the PBPK



model does not contain a mammary tissue compartment, and since there is no adequate data on the metabolism of VC in mammary tissue to construct one, a “zero order approximation” approach was utilized in which metabolism of VC in the liver was used as a surrogate for *in situ* metabolism in mammary tissue. Thus, the same liver dose-metrics, “RISK,” i.e., steady-state concentration of the active metabolite per L liver tissue, were calculated for the conditions and doses of the bioassays showing increased incidence of mammary tumors. See table 8 in the appendix B. The 95% upper confidence limits of mammary tumor risk in female mice and rats, based upon the dose metric “RISK” for studies in which an increase in mammary tumors was seen, are listed below. Use of “RISK” results in a conservative estimate of cancer potency since it is assumed that mammary tissue metabolizes at the same rate as liver tissue, which is considered unlikely.

Estimated risks from mammary tumors in several studies reported by Maltoni et al. (1981,1984) were quite small ranging from  $3 \times 10^{-7}$  to  $3 \times 10^{-6}$  per  $ug/m^3$ , with one exception, for which a risk of  $1 \times 10^{-4}$  per  $ug/m^3$  was derived (table 10 in appendix B). In the latter case, increases occurred against a very high background ( $\approx 50\%$ ), raising the possibility that VC was promoting or synergising with an ongoing process, if indeed there was any biological increase at all. The high background incidence in all the Sprague-Dawley groups renders conclusions based upon this strain uncertain. Wistar rats have a much lower background incidence. In studies reported by Maltoni et al. (1981, 1984) using Wistar rats, control incidence was less than 5%; among groups exposed up to 10,000 ppm and the incidences were even lower and in some cases zero. In the Feron et al. (1983) study, while elevated, but not statistically significant increases were reported for mammary carcinomas, mammary fibroadenomas showed a significantly decreased incidence. Because of a lack of dose-response in the studies used in attempts to quantitate mammary tumor risk, fit was rejected in all but one case, and in that case the fit was poor.

Increases in nephroblastoma were noted only in the Maltoni et al. (1981,1984) studies. Risk estimates were also quite small, ranging from  $8 \times 10^{-8}$  to  $1 \times 10^{-6}$  per  $ug/m^3$  (Table 9 in appendix B). No evidence for nephroblastoma was reported in the Feron et al. (1983) study, even though a high incidence of liver tumors occurred. Concern regarding risk from induction of nephroblastoma are also decreased because increases in these tumors were not observed in the epidemiology studies.

Suggestive evidence for tumors at other sites in humans has also been noted, but increases were generally small compared to liver tumors. For example, in a recent update of the “American” cohort by CMA (1998b), significant increases in brain and connective tissue tumors were reported. However, the estimated increase in mortality from these sources is only about one third that from liver cancer. Despite the apparent limited risk from nonliver tumors, some concern nevertheless remains. The Influence of VC exposure on breast cancer induction has never evaluated adequately in humans, because occupational studies have generally been limited to males. Although animal studies reported by Drew et al. (1983) are unsuitable for dose-response analysis because single exposure levels were used, increases in mammary tumors were noted in three species.

Given the increases in mammary or kidney tumors found in some animal studies, suggestive evidence for increases in sites other than the liver in some epidemiologic studies, and the fact that

the epidemiology studies generally fail to account for sensitive members of the population, the application of an uncertainty factor of three to the risk estimates based upon liver cancer is recommended. Note that uncertainty factors for a given topic generally range from 1 to 10. A choice of 3 reflects a definitive uncertainty, though modest in magnitude.

#### **5.3.5.2. *Basis for Recommending Adjustment in Cancer Risk Estimates to Account for Early-Life Sensitivity.***

Several studies have compared the carcinogenic effects of VC in newborn and adult animals. Newborn rats treated with VC respond with both angiosarcoma and hepatocellular carcinoma, in contrast with adult animals exposed via inhalation, in which angiosarcoma is more common (Maltoni et al., 1981). Consistent with this observation, VC was found to induce preneoplastic foci in newborn rats, but not in adult rats (Laib et al., 1979). Interestingly, in the same study it was found that VC did induce preneoplastic foci in adult rats after partial hepatectomy, indicating that the appearance of foci, and presumably of hepatocellular carcinoma, in neonatal animals was a consequence of the increased rate of cell proliferation at that age. Similarly, Laib et al. (1989) found that inhaled radiolabeled VC was incorporated into physiological purines of 11-day-old Wistar rats at eightfold higher levels than in similarly treated adult rats (presumably reflecting the DNA replication activity), and roughly fivefold higher levels of the DNA adduct 7-N-(2-oxyethyl)guanine (OEG) were found in the livers of young animals, reflecting an increased alkylation rate. It should be noted, however, that neoplastic nodules and hepatocellular carcinoma were induced in rats exposed to VC in the diet. Although OEG is not believed to be a precarcinogenic lesion, it is reasonable to expect that levels of this adduct would correlate with the levels of the precarcinogenic VC adducts. In a similar study, roughly fourfold greater concentrations of both OEG and EG were also seen in preweanling rats exposed to VC (Fedtke et al., 1990).

Drew et al. (1983) studied the effect of age and exposure duration on cancer induction by VC in rats, mice, and hamsters. In this study, female golden Syrian hamsters, F344 rats, Swiss CD-1 mice, and B6C3F1 mice were exposed for 6 hours/day, 5 days/week to carcinogenic levels of VC (50, 100, or 200 ppm for mice, rats, and hamsters, respectively) for 6, 12, 18, or 24 (rats and hamsters only) months. All animals were sacrificed at month 24, and about 50 animals/species/group were tested. Other groups of rodents were held 6 to 12 months, then exposed for 6 or 12 months, and sacrificed also at month 24. Unfortunately, time-to-tumor data were not reported in this study, making it impossible to deconvolute the impact of survival on the observation of tumors from later exposure periods. Moreover, both mice and hamsters showed significant survival effects (life shortening) from the VC exposures, and the data could not be used for comparison of exposure periods. Therefore, only the data on exposures of rats during the first 12 months of life are appropriate for analysis. In the rats, exposure from 0 to 6 months showed an overall similar potency to exposure from 6 to 12 months of life. In particular, the incidence of hepatocellular carcinoma and hemangiosarcoma was 4.0% and 5.3%, respectively, in rats exposed from 0 to 6 months, while for exposure from 6 to 12 months, the incidence was 11.5% and 3.8%, respectively.

Although the reactive nature of the carcinogenic metabolites and the lack of P450 activity in rodent fetuses would suggest that VC is not a transplacental carcinogen (Bolt et al., 1980), data from Maltoni et al. (1981) indicate that it is. Pregnant rats were exposed from gestation day 12-18 to 6,000 or 10,000 ppm VC for 4 hours/day, and tumors were ascertained at 143 weeks postexposure. Nephroblastomas, forestomach tumors, epithelial tumors, and mammary gland carcinomas were observed only in the offspring, and the incidence of Zymbal gland carcinomas was higher in transplacentally exposed animals than in maternal animals. Since the dams and offspring were followed for the same period, latency is not an issue for this experiment. However, it is important to note that the offspring were exposed during organogenesis, a period of rapid cell division, and any genotoxic carcinogen would be expected to have a higher potency during this period. This apparent increased sensitivity of newborn animals occurs in spite of a much lower metabolic capability at birth: during the first week of life, the P450 activity in the liver of rats increases from about 4% to about 80% of adult levels (Filser and Bolt, 1979). Since the fetuses did not possess the capability to metabolize VC, these data suggest that CEO was formed in the dam's liver and then transported across the placenta to the fetuses.

Studies such as those by Laib et al. (1985) and Maltoni et al. (1981) indicate that young animals have an enhanced sensitivity to VC carcinogenicity. Indeed, the higher cell proliferation rates found in newborn animals would seem to suggest that VC, or any other DNA-reactive carcinogen, could be more potent in newborns than in adults. Guidance has previously been given to the Regional Offices to double the lifetime risk estimate for VC to account for the additional risk attributable to early-life exposures (Cogliano, 1989, 1990; Cogliano and Parker, 1992).

Animal studies of partial lifetime exposure to VC suggest that the lifetime cancer risk depends on the age at exposure, with higher lifetime risks attributable to exposures at younger ages. The results suggest that the potential for VC to cause cancer is greatest for newborn exposure. Maltoni et al. (1981) demonstrated that a brief exposure in newborn animals can, by the end of life, induce a higher incidence of tumors compared with long-term exposure occurring later in life, including tumors not induced by exposure later in life. Mechanistic studies are consistent with these tumor findings and reveal an increased potential for carcinogenic activity in newborn animals. Although there is no direct evidence of increased human sensitivity to VC-induced carcinogenicity with exposure during childhood or adolescence, the animal evidence of such age-dependent sensitivity warrants concern for young children potentially exposed to VC.

Several observations can be made about the early-life studies.

1. Exposure periods in the early-life studies (weeks 1–5 for Maltoni et al., 1981, and days 7–21 for Laib et al., 1985) do not overlap those of the chronic studies (weeks 14–65) from which chronic slope factors and unit risks are derived.
2. The angiosarcoma incidence after short-term, early-life exposure is approximately equal to that of long-term exposure starting after maturity (see Table 7).
3. Because the effects of early-life exposure are qualitatively and quantitatively different from those of later exposures, it would not be appropriate to prorate early-life exposures as if they were received at a proportionately lesser rate over a full lifetime.

These observations imply that slope factors and unit risks should be amended to reflect the potential for increased sensitivity early in life. The first observation (nonoverlapping exposure periods) suggests that the full lifetime cancer risk can be approximated by adding risks from the nonoverlapping exposures in early life and later. The second observation suggests that the angiosarcoma risks from these nonoverlapping periods are approximately equal. The third observation suggests that the risk from early-life exposure should not be prorated over a longer duration. The experimental studies suggest that the risk from short-term exposure immediately after birth may not be reversible even in the absence of further exposure later in life. This would effectively double the VC slope factors and unit risks; one portion would apply to any early-life exposure; the other, to exposures later in life.

In applying these results to partial lifetime exposure, the later-life portion can be apportioned according to a curve that declines with age (Cogliano, 1989, 1990; Cogliano and Parker, 1992; Cogliano et al., 1996; Hiatt et al., 1994). In contrast, early-life exposures would not be prorated over a longer duration. (A simpler approach would be to prorate later-life exposures over the lifespan, while not prorating early-life exposures.) The following examples illustrate these adjustments. In each example,  $1 \times 10^{-6}$  is used as an example of a unit risk estimate.

Example 1. Full lifetime exposure (birth through death) to  $1 \mu\text{g}/\text{m}^3$ .

$$\text{Early-life risk: } (1 \times 10^{-6} \text{ per } \mu\text{g}/\text{m}^3) \times (1 \mu\text{g}/\text{m}^3) = 1 \times 10^{-6}.$$

$$\text{Later-life risk: } (1 \times 10^{-6} \text{ per } \mu\text{g}/\text{m}^3) \times (1 \mu\text{g}/\text{m}^3) = 1 \times 10^{-6}.$$

$$\text{Total risk: } 2 \times 10^{-6}.$$

Here the total risk is made up of two components, an early-life risk and a later-life risk. The unit risk for each component is taken to be  $1 \times 10^{-6}$ .

Example 2. Exposure to  $2 \mu\text{g}/\text{m}^3$  from ages 30-60.

Early-life risk: Not applicable.

$$\text{Later-life risk: } (1 \times 10^{-6} \text{ per } \mu\text{g}/\text{m}^3) \times (2 \mu\text{g}/\text{m}^3) \times (30/70) = 0.9 \times 10^{-6}.$$

$$\text{Total risk: } 0.9 \times 10^{-6}.$$

Here exposure begins at age 30, so there is no early-life component. The later-life component is prorated as a duration of 30 years over an assumed lifespan of 70 years.

Example 3. Exposure to  $5 \mu\text{g}/\text{m}^3$  from ages 0-10.

$$\text{Early-life risk: } (1 \times 10^{-6} \text{ per } \mu\text{g}/\text{m}^3) \times (5 \mu\text{g}/\text{m}^3) = 5 \times 10^{-6}.$$

$$\text{Later-life risk: } (1 \times 10^{-6} \text{ per } \mu\text{g}/\text{m}^3) \times (5 \mu\text{g}/\text{m}^3) \times (10/70) = 0.7 \times 10^{-6}.$$

$$\text{Total risk: } 5.7 \times 10^{-6}.$$

Here there is an early-life component that is not prorated. The later-life component is, however, prorated as 10 out of 70 years.

In general, the potential for added risk from early-life exposure to VC is accounted for in the quantitative cancer risk estimates by a twofold uncertainty factor. If exposure occurs only during adult life, the twofold factor need not be applied.

### **5.3.5.3. Confidence in the dose-response assessment**

Confidence in the dose-response assessment is medium to high for a number of reasons. VC has been shown to be carcinogenic in a large number of animal bioassays as well as in epidemiologic studies. The primary target site and major tumor types are also the same in experimental animals and humans. VC is a well-characterized genotoxic carcinogen. Its carcinogenic activity is attributed to the formation of DNA adducts by the highly reactive VC metabolite CEO. There is strong evidence linking etheno-DNA adducts with observed carcinogenicity. This increases confidence in extrapolating to low doses using either the ED10 method or the LMS model.

Recommendations from epidemiologic based estimates were not made due to the limitations of the studies. The low dose-response estimates nevertheless provide support for assuming the animal based estimates are sufficiently conservative (see appendix B). The epidemiologic studies also provided evidence that, while tumors may be induced at other sites, the estimated increases are considerably less than for liver tumors, resulting in increased confidence that a threefold uncertainty factor to account for nonliver tumor risk is adequate. It should be noted, however, that while these risk estimates are quite low, they are based primarily upon healthy male workers and do not account for sensitive members of the population. Some uncertainty also remains because of lack data on possible induction of breast cancer in females by VC.

The use of a PBPK model to determine target site concentration of the active metabolite allows a more accurate estimate of dose-response than default methods. Uncertainty in the PBPK model was determined by conducting a Monte Carlo analysis, in which risk is calculated by sampling the distributions of the parameters used in the model, resulting in a distribution of calculated risks. This analysis for the VC model found that the 95th percentile of the distribution of upper confidence limit (UCL) risks was within 50% of the mean UCL risk. Furthermore, in a sensitivity/uncertainty analysis of the parameters used in the model, none of the parameters displayed sensitivities markedly greater than 1.0, indicating that there is no amplification of error from the inputs to the outputs. This is, of course, a desirable trait in a model to be used for risk assessment. The parameters with a significant impact on the calculated dose metric (and thus the risk) were: body weight (BW), alveolar ventilation (QPC), cardiac output (QCC), liver blood flow (QLC) and volume (VLC), blood/air partition coefficient (PB), the capacity (VMAX1C) and affinity (KM1) for metabolism by CYP2E1, and, in the case of oral gavage, the oral uptake rate (KA). All of these parameters could be reasonably well characterized from experimental data. However, the sensitivity of the risk predictions to the human values of these parameters implies that the risk from exposure to VC could vary considerably from individual to individual, depending on the specific physiology, level of activity, and metabolic capability.

Pharmacodynamics were not addressed by the PBPK model. Since the dose metric is the amount of reactive metabolite produced, and the reactive metabolite is believed to interact directly with DNA, pharmacodynamics in animals and humans would be expected to be similar. There is also little evidence from bioassays and epidemiologic data for significant differences in responsiveness of laboratory species and humans to VC. Some uncertainty, however, remains due to potential interspecies differences in the steps between fixation of the mutagenic lesion and development of the tumor.

## **6. MAJOR CONCLUSIONS IN CHARACTERIZATION OF HAZARD AND DOSE RESPONSE**

### **6.1. HUMAN HAZARD POTENTIAL**

#### **6.1.1. Hazard Identification for Cancer Effects**

The association between occupational exposure to VC and the development of liver angiosarcomas is one of the best characterized cases of chemical-induced carcinogenicity in humans. Liver angiosarcomas are an extremely rare tumor with only 20-30 cases per year reported in the United States. Since the introduction of VC manufacturing, a significant percentage of reported cases have been associated with VC exposure. VC exposure has also been associated with increased death due to primary liver cancer, as well as cancer of the brain, lung, and lymphopoietic system. The association of VC with angiosarcoma in numerous epidemiologic studies has been supported by findings in rats, mice, and hamsters administered VC via the oral and inhalation routes. The mode of action is also well understood. VC is metabolized to a reactive metabolite, probably CEO, which interacts with DNA, forming DNA adducts, and ultimately leading to tumor formation.

On the basis of sufficient evidence for carcinogenicity in human epidemiology studies, VC is therefore considered to best fit the weight-of-evidence Category “A”, according to current EPA Risk Assessment Guidelines (U.S. EPA, 1986). Agents classified into this category are considered to be known human carcinogens. Under the Proposed Guidelines for Carcinogen Risk Assessment (U.S.EPA, 1996), it is concluded that VC is a known human carcinogen by both the oral and inhalation routes of exposure, but has not been tested dermally. See Section 4.6 for further details.

#### **6.1.2. Hazard Identification for Noncancer Effects**

The liver is the primary target for the noncancer effects of VC in animals (Bi et al., 1985; Feron et al., 1981; Sokal et al., 1980; Til et al., 1983, 1991) and humans (Buchancova et al., 1985; Doss et al., 1984; Gedigk et al., 1975; Lilis et al., 1975; Marsteller et al., 1975; Popper and Thomas, 1975; Tamburro et al., 1984). Pathological effects such as liver necrosis, liver cell polymorphism, and cysts as well as alterations in liver function have been reported. Neurological effects reported in some occupational studies are associated with exposure levels much higher

than those that cause liver injury. Acroosteolysis, or resorption of the terminal phalanges of the fingers, was observed in workers occupationally exposed to vinyl chloride (Lillis et al., 1975; Marsteller et al., 1975), often preceded by clinical signs of Reynaud's phenomenon (Fontana et al., 1995). This was most often seen in tank cleaners and is apparently associated with dermal exposure. Occupational exposures at high concentrations may induce headaches, drowsiness, dizziness, ataxia, and loss of consciousness (Lillis et al., 1975; Langauer-Lewowicka et al., 1983; Waxweiler et al., 1977). Reproductive effects and testes damage occurred in rats exposed to VC (Short et al., 1977; CMA, 1988a; Bi et al., 1985). These endpoints, however, were generally noted at concentrations greater than those necessary to cause liver damage.

Although most of the animal and human data result from inhalation studies, these data are directly applicable to oral exposure, because VC is rapidly absorbed and distributed throughout the body following oral or inhalation exposure. First-pass metabolism is not a major issue since the initial function of the liver is activation rather than inactivation. However, initial liver concentration may be greater via oral dosing because essentially all absorbed VC passes through the liver before possibly entering the systemic circulation.

## **6.2. DOSE RESPONSE**

### **6.2.1. Dose Response for Cancer Effects**

Cancer potency of VC in humans is based on animal experiments because of uncertain exposure levels in epidemiology studies. Estimated risk from continuous lifetime inhalation exposure to VC is  $8.7 \times 10^{-6}$  per  $\mu\text{g}/\text{m}^3$ . Estimated lifetime cancer risk from oral exposure to VC is 2.5 per mg/kg-day. Risk is estimated to equal one-half these values for continuous lifetime exposure during adulthood only. The recommended values include a threefold uncertainty factor to account for possible increases in risk due to cancer induction at sites other than the liver.

Quantitation is based upon the rat feeding study reported by Feron et al. (1983) and rat and mouse inhalation studies reported by Maltoni et al. (1981, 1984). The Maltoni et al. (1981, 1984) studies included both mice and rats exposed to a wide range of concentrations. The Feron et al. (1983) studies included three exposure levels and is supported by a subsequent study by (Til et al., 1991), conducted under nearly identical conditions that included two lower exposures. The studies were well designed and utilized adequate numbers of animals.

Risk estimates were based upon concentration of the active metabolite of VC, chloroethylene oxide (CEO) in the liver. CEO concentrations were derived using a PBPK model that accounted for species variability in factors such as ventilatory exchange rates, blood-air partition coefficients, metabolic activation rates, organ volumes, etc. Use of this model allows a more accurate estimation of risk than previously used default models. A body surface area correction was not applied because the PBPK model adjusts for differences in metabolic rate among species. Pharmacodynamics were not addressed by the PBPK model. However, since the dose metric is the amount of reactive metabolite produced, and the reactive metabolite is believed to interact directly with DNA, pharmacodynamics in animals and humans are expected to be similar.

Several studies have provided evidence for early life sensitivity. Maltoni et al. (1981) reported markedly increased cancer incidence in rats exposed via inhalation beginning at one day of age compared with those exposed beginning at 13 weeks of age. Mice, rats and hamsters were shown to be more sensitive to cancer induction if exposed at a younger age (Drew et al., 1983). Vinyl chloride induction of preneoplastic liver foci in rats are restricted to exposures at approximately 7 to 21 days of age (Laib et al., 1979). None of these studies were considered to be suitable for deriving recommended unit risk estimates because of short exposure durations, single exposure levels, or reporting of endpoints other than cancer. The Maltoni et al. (1991), Drew et al. (1983), and Laib et al (1979) studies, however, provide a basis for recommending a two-fold adjustment of estimated risk to account for early life exposure.

A threefold uncertainty factor was adopted to account for possible induction of nonliver tumors. This decision is a result of limited evidence for induction of tumors at sites such as the mammary gland and kidneys in laboratory species, brain, soft tissue and connective tissue in humans. An uncertainty factor was adopted because the sporadic nature of the nonliver tumor responses in animal bioassays and limited evidence in humans, rendered potency estimates based on nonliver tumors very uncertain. While most available data indicate that risk would be increased less than three-fold by inclusion of non liver tumors, a conservative recommendation for a three-fold uncertainty factor is made because of a lack of human data for possible breast cancer induction.

While results of several epidemiology studies were positive for liver cancer, exposure concentrations were of sufficient uncertainty to preclude recommendation of risk estimates derived from these studies. Considerable variation in exposure was likely in the larger studies that included cohorts from several facilities. Duration of exposure at high concentrations, a variable necessary to determine the fraction of VC metabolized to its active metabolite was often unavailable.

Despite their limitations several epidemiology studies have been used to estimate cancer risk. The study by Fox and Collier (1977) provided the best data set with respect to providing information regarding duration of employment and exposure level groupings. Chen and Blancato (1989) used this study to derive a unit risk estimate of about  $1.5 \times 10^{-6}$  per  $\mu\text{g}/\text{m}^3$ . The weakness of the study is the small cohort with only two cases of liver angiosarcoma. An estimate of  $1 \times 10^{-6}$  per  $\mu\text{g}/\text{m}^3$  was derived based upon autoclave workers in the Jones et al. (1988) study, an update of the Fox and Collier (1977) study. Reitz et al. (1996) reported that the unit risk estimate of  $5.7 \times 10^{-7}$  per  $\mu\text{g}/\text{m}^3$  they derived from animal data, predicted tumor counts in humans, based upon exposure estimates in the Simonato et al (1991) study, as much as 35-fold greater than actually reported. While this study had a larger cohort and more deaths due to liver cancer (24), exposure uncertainty was also greater because data was collected from many different workplaces in several countries. It should also be noted, that since many of the workers were still alive when these calculations were made, with the likelihood of further deaths from liver cancer, overprediction of human risk may be less than reported.

While epidemiology-based risk estimates are conservative compared with animal-based ones, the occupational cohorts used lack females, children, and other potentially sensitive members of the population. The epidemiology-based based estimates also did not account for the possibility of tumor induction at sites other than the liver. Nevertheless, the epidemiology-based



estimates, collectively provide support for the recommended values and suggest that the present estimates are unlikely to underestimate human risk.

As discussed in Section 5.3.1, use of DNA adduct levels could be considered as the basis for a VC risk estimate. However, adduct levels cannot be used directly to extend tumor dose-response data to lower doses, since tumor formation from adducts depends on many factors, including the consequences of adduct repair or failure to be repaired. Thus, although a quantitative analysis of the relationship between VC metabolism, adduct formation, and tumor formation is likely to be a fruitful area for additional research, it is premature to attempt to establish a quantitative link between the tissue concentrations of a specific adduct and the risk of cancer in that tissue.

Confidence in the risk assessment is increased by the availability of appropriately designed and conducted studies, understanding of the mechanisms of VC carcinogenicity, allowing risk to be based upon concentration of the active metabolite, and the fact that risks based on liver angiosaromas (rare tumors in both animals and humans) are in close agreement. VC is a well-characterized genotoxic carcinogen. Carcinogenic activity of VC is attributed to the formation of DNA adducts by the highly reactive VC metabolite CEO. Therefore, there is considerable confidence in extrapolating to low doses using either the ED10 method or the LMS model. A Monte Carlo analysis, in which risk is calculated by sampling the distributions of the parameters used in the model, resulting in a distribution of calculated risks determined that the 95th percentile of the distribution of upper confidence limit (UCL) risks was within 50% of the mean UCL risk. Furthermore, in a sensitivity/uncertainty analysis of the parameters used in the model, none of the parameters displayed sensitivities markedly greater than 1.0, indicating that there is no amplification of error from the inputs to the outputs.

Confidence in the risk estimates are are decreased somewhat by uncertainty regarding the possible effect of nonliver tumors on cancer potency. This is especially true for endpoints such as the mammary gland, for which some animal studies suggest an additional risk, but for which human data is lacking. However, the available epidemiological data suggests that any additional degree of risk is likely to be modest and is expected to be accounted for by the adoption of a three-fold uncertainty factor.

Overall, confidence in the overall assessment is medium to high.

### **6.2.2. Dose Response for Noncancer Effects**

The quantitative estimates of human risk as a result of low-level chronic exposure to VC are based on animal experiments because of uncertainties regarding human exposure levels to VC.

The human oral dose that is likely to be without an appreciable risk of deleterious noncancer effects during a lifetime (the RfD) is  $5E-5$  mg/kg-day.

Confidence in the principal study is high. The study of Til et al. (1983, 1991) used adequate numbers of animals, was well controlled, and reported in detail on the histological

effects on the liver. There are several corroborative inhalation studies that observed effects on the liver and testes in rodents following inhalation exposure. Medium confidence in the database results from a lack of a two-generation reproductive study. Other gaps in the oral database can be filled based on inhalation toxicity data. Two developmental inhalation studies (John et al., 1977; Ungvary et al., 1978) were located that reported embryotoxic effects only at levels much higher than those causing maternal toxicity in mice, rats, or rabbits. There is no evidence for other effects at doses as low as those inducing effects in the Til et al. (1991) study. The two generation reproductive study of CMA, (1998) demonstrates liver effects at concentrations where reproductive effects were absent indicating the sensitivity of the liver relative to any effects on reproduction. Too, in a dominant lethal study of VC, reduced fertility was observed at a concentration greater than that inducing liver effects in rats (Short et al., 1977). These data impart considerable certainty that in the dose-response relationship of VC, liver effects would occur before reproductive-related effects. Therefore, the confidence in the database is considered high to medium.

Qualitative differences exist between the dose metrics generated from the PBPK model used in this assessment. This difference is due principally to the extent of information available for validating the dose metrics derived from different routes of exposure, i.e., inhalation and oral. As documented in Appendix B, numerous data sets are available via the inhalation route to both parameterize and judge the ability of the model to characterize aspects of VC dosimetry, including the dose metrics used in this assessment, that occur in an inhalation scenario. Data sets for the oral route, however, are few and problematic (Appendix B), which limits the ability to either parameterize or to judge performance of the model. Thus, a higher degree of confidence is placed in dose metrics derived from inhalation scenarios than in those derived from oral scenarios. To attempt to compensate for this qualitative difference between the oral and inhalation dose metrics, certain procedures were instituted within the model when calculating oral dose metrics, including assumption of a maximum rate of VC uptake (i.e., designating it a zero-order process) and spreading the applied dose over a 24-hr period, which would minimize the concentration and maximize the likelihood that the parent VC would be metabolized to reactive species (i.e., the basis of this assessment, mg VC metabolized).

The high degree of confidence in the principal study of Til et al. (1983, 1991), combined with the high-to-medium assessment of the database and less than high confidence in the qualitative aspects of the PBPK, is considered to result in an overall medium confidence in the RfD.

An uncertainty factor of 10 was used for protection of sensitive human subpopulations and 3 for animal to human extrapolation. The uncertainty factor of 10 for intraspecies variability includes the variability in risk estimates that would be predicted by the model for different individuals, due to variability in physiology, level of activity, and metabolic capability. A factor of 3 was used for interspecies extrapolation because although PBPK modeling refines the animal to human comparison of delivered dose, it does not address the uncertainty regarding the toxicodynamic portion of interspecies extrapolation (relating to tissue sensitivity). No uncertainty factor for was considered necessary for deficiencies in this relatively complete data base.

Daily inhalation exposure to a human population that is likely to be without an appreciable risk of deleterious effects during a lifetime (the RfC) is  $1\text{E-}1 \text{ mg/m}^3$ . The RfC is based on the same study used to derive the RfD (Til et al., 1983, 1991). As noted above, confidence in this study is high. An oral study was used to derive the RfC because it was the best study available, effects were reported at lower doses than in any of the inhalation studies, and use of the PBPK model allowed accurate route extrapolation of reactive metabolite.

The overall confidence in the RfC is medium. The study of Til et al. (1983, 1991) used adequate numbers of animals, was well controlled, and reported in detail on the histological effects on the liver. Since the PBPK model can be used to calculate tissue doses for oral and inhalation exposure, detailed information on a range of endpoints is available. There are several corroborative inhalation studies that observed effects on the liver and testes in rodents following inhalation exposure. Two developmental inhalation studies (John et al., 1977; Ungvary et al., 1978) were located that reported embryotoxic effects only at levels much higher than those causing maternal toxicity in mice, rats, or rabbits. Results from both the reproductive study of CMA (1998) and, to a lesser degree, the dominant lethal study of Short et al. (1977) clearly indicate that liver effects occur at exposures to VC much less than any reproductive effect or parameter examined in these studies.

As discussed for the RfD, there exist qualitative differences between dose metrics generated from oral and inhalation routes by the PBPK model used in this assessment. Data sets for the oral route are problematic and few (Appendix B), which limits the ability to either parameterize or to judge performance of the model. This RfC is based on dose metrics derived from the dietary administration study of Til et al (1983, 1991). Actions taken to compensate for this qualitative deficiency were those described above for the RfD, the overall intent being to maximize the likelihood of the administered dose to be transformed to reactive C metabolites in the liver, to obtain the maximum dose metric from any oral dose.

Comparable to the RfD, an uncertainty factor of 10 was used for protection of sensitive human subpopulations and 3 for animal to human extrapolation. The uncertainty factor of 10 for intraspecies variability includes the variability in risk estimates that would be predicted by the model due to population variability, and a factor of 3 was used for interspecies extrapolation to address uncertainty relating to potential interspecies differences in tissue sensitivity.

Since VC toxicity results from a reactive metabolite generated by P450 enzymes, individuals who generate increased amounts of the toxic metabolite due to the induction of these enzymes comprise a sensitive population. The P450 inducers phenobarbital and Aroclor 1254 induce VC metabolism and have been shown to increase VC toxicity (Jaeger et al., 1977; Jedrychowski et al., 1985; Reynolds et al., 1975). Increased sensitivity would also be expected in people with pre-existing liver disease.

Although VC has often been cited as a chemical for which saturable metabolism should be considered in the risk assessment, saturation appears to become important only at very high exposure levels (greater than 250 ppm by inhalation or 25 mg/kg-day orally) compared with levels associated with the most sensitive noncancer effects or tumorigenic levels, and thus has little impact on the risk estimates. The important contribution of pharmacokinetic modeling is to

provide a more biologically plausible estimate of the effective dose: total production of reactive metabolites at the target tissue. The ratio of this biologically effective dose to exposure concentration or administered dose is not uniform across routes and species. Therefore, any estimate of administered dose is less adequate for performing route-to-route and interspecies extrapolation of risk.

The major area of scientific uncertainties in this assessment is a quantitative characterization of the variability in the human population and the increased sensitivity of sensitive populations. This area is compensated for with a default uncertainty factor. As noted in Section 5.1.1, the LOAEL used by ATSDR (1995) in its calculation of a chronic oral MRL is considerably lower than the NOAEL and BMD<sub>10</sub> identified for the RfD (without consideration of pharmacokinetics). This discrepancy resulted because ATSDR did not take into consideration the preneoplastic nature of its critical effect, the proliferative basophilic foci in the Til et al. (1983, 1991) study. As also noted in Section 5.2.1, ATSDR (1995) considered increased relative heart and spleen weights (Bi et al., 1985) to be co-critical effects in its calculation of an intermediate duration inhalation MRL. These effects were not considered for the derivation of the RfC because of the absence of a concentration- or duration-related response and because they occurred at higher concentrations than liver cell polymorphisms used to derive both the RfC and RfD.

It should be noted, however, that the most significant effect of VC observed in human epidemiologic studies is liver cancer. The observation that the cancer effects of VC dominate at high human exposure concentrations, coupled with the fact that VC is a genotoxic carcinogen for which linear low-dose extrapolation is appropriate, suggests that the noncancer effects of VC are not likely to be as important a concern for chronic human exposure.

## 7. REFERENCES

Afzelius, BA; Schoental, R. (1967) The ultrastructure of the enlarged hepatocytes induced in rats with a single oral dose of retrorsine, a pyrrolizidine (Senecio) alkaloid. *J Ultrastruct Res* 20:328-345.

Agency for Toxic Substances and Disease Registry (ATSDR), Public Health Service, U.S. Department of Health and Human Services. (1995) Toxicological profile for vinyl chloride. Draft for public comment.

Andersen, M; Clewell, H; Gargas, M; et al. (1987) Physiologically based pharmacokinetics and the risk assessment process for methylene chloride. *Toxicol Appl Pharmacol* 87:185-205.

Bartsch, H; Malaveille, C; Montesano, R. (1975) Human, rat and mouse liver-mediated mutagenicity of vinyl chloride in *S. typhimurium* strains. *Int J Cancer* 15:429-437.

Belli, S; Bertazzi, PA; Comba, P; et al. (1987) A cohort study on vinyl chloride manufacturers in Italy: study design and preliminary results. *Cancer Lett* 35:253-261.

Berk, PD; Martin, JF; Young, RS; et al. (1976) Vinyl chloride-associated liver disease. *Ann Intern Med* 84:717-731.

Bi, W; Wang, Y; Huang, M; et al. (1985) Effect of vinyl chloride on testis in rats. *Ecotoxicol Environ Saf* 10:281-289.

Bolt, HM. (1978) Pharmacokinetics of vinyl chloride. *Gen Pharmacol* 9:91-95.

Bolt, HM. (1986) Metabolic activation of vinyl chloride, formation of nucleic acid adducts and relevance to carcinogenesis. *IARC Sci Publ* 70:261-268.

Bolt, HM; Kappus, H; Buchter, A; et al. (1976) Disposition of [1,2-<sup>14</sup>C] vinyl chloride in the rat. *Arch Toxicol* 35:153-162.

Bolt, HM; Laib, RJ; Kappus, H; et al. (1977) Pharmacokinetics of vinyl chloride in the rat. *Toxicology* 7:179-188.

Bolt, HM; Laib, RJ; Filser, JG; et al. (1980) Vinyl chloride and related compounds: mechanisms of action on the liver. In: *Frontiers in liver disease*. Berk, PD; Chalmers, TC, eds. New York: Thieme/Stratton, p. 80.

Bos, JL. (1989) Ras oncogenes in human cancer: a review. *Cancer Res* 49:4682-4689.

Buchancova, J; Reznak, I; Horak, V; et al. (1985) Scintigraphic pictures of the liver in workers after a long-term exposure to vinyl chloride. *Pracov Lek* 37:190-194.

Buffler, PA; Word, S; Eifler, C; et al. (1979) Mortality experience of workers in a vinyl chloride monomer production plant. *J Occup Med* 21:195-203.

Bull, RJ; Brown, JM; Meierhenry, EA; et al. (1986) Enhancement of the hepatotoxicity of chloroform in B6C3F1 mice by corn oil: implications for chloroform carcinogenesis. *Environ Health Perspect* 69:49-58.

Byren, D; Engholm, G; Englund, A; et al. (1976) Mortality and cancer morbidity in a group of Swedish VCM and PVC workers. *Environ Health Perspect* 17:167-170.

Chemical Manufacturers Association (CMA) (1998a) Vinyl chloride combined inhalation two-generation reproduction and developmental toxicity study in CD rats. Final Report: CMA, Arlington VA.

Chemical Manufacturers Association (CMA) (1998b) Epidemiological study of men employed in the vinyl chloride industry between 1942 and 1972: I. Re-analysis of mortality through December 31, 1982; and II. Update of Mortality through December 31, 1995. Final Report. CMA, Arlington VA. pp. 1-178.

Chen, CW; Blancato, JN. (1989) Incorporation of biological information in cancer risk assessment: example—vinyl chloride. *Cell Biol Toxicol* 5:417-444.

Cheng, KC; Preston, BD; Cahill, DS; et al. (1991) The vinyl chloride DNA derivative N<sup>2</sup>,3-ethenoguanine produces G→A transitions in *Escherichia coli*. Proc Natl Acad Sci 88:9974-9978.

Clement Associates. (1987) Investigation of cancer risk assessment methods. Final report. Vol. 1: Introduction and epidemiology. Prepared for the U.S. Environmental Protection Agency, the U.S. Department of Defense, and the Electric Power Research Institute.

Clewell, HJ; Gentry, PR; Gearhart, JM; et al. (1995a) The development and validation of a physiologically based pharmacokinetic model for vinyl chloride and its application in a carcinogenic risk assessment for vinyl chloride. Prepared by ICF Kaiser for the Office of Health and Environmental Assessment, U.S. Environmental Protection Agency, and the Directorate of Health and Standards Programs, Occupational Safety and Health Administration, Washington, DC.

Clewell, HJ; Covington, TR; Crump, KS; et al. (1995b) The application of a physiologically based pharmacokinetic model for vinyl chloride in a noncancer risk assessment. Prepared by ICF Kaiser/Clement Associates for the National Center for Environmental Assessment, U.S. Environmental Protection Agency, Washington, DC, under EPA contract number 68-D2-0129.

Clewell, HJ; Gentry, PR; Gearhart, JM; et al. (1995c) Considering pharmacokinetic and mechanistic information in cancer risk assessments for environmental contaminants: examples with vinyl chloride and trichloroethylene. Chemosphere 31:2561-2578.

Cogliano, J. (1989) Status of vinyl chloride assessment (memorandum). National Center for Environmental Assessment, U.S. Environmental Protection Agency, Washington, DC.

Cogliano, J. (1990) Cancer unit risk estimates for vinyl chloride (memorandum). National Center for Environmental Assessment, U.S. Environmental Protection Agency, Washington, DC.

Cogliano, VJ; Parker, JC. (1992) Some implications of toxicology and pharmacokinetics for exposure assessment. J Exp Environ Epidemiol Suppl 1:189-207.

Cogliano, VJ; Hiatt, GFS; Den, A. (1996) A quantitative cancer assessment for vinyl chloride: indications of early-life sensitivity. Toxicology 111:21-28.

Cooper, WC. (1981) Epidemiologic study of vinyl chloride workers: mortality through December 31, 1972. Environ Health Perspect 41:101-106.

Cowfer, JA; Magistro, AJ. (1983) Vinyl chloride. In: Encyclopedia of chemical technology, vol. 23. Othmer, K, ed. New York: Wiley Interscience, pp. 865-885.

Creech, JL; Johnson, MN. (1974) Angiosarcoma of the liver in the manufacture of polyvinyl chloride. J Occup Med 16:150-151.

DeAngelo, AB; Daniel, FB; McMillan, L; et al. (1989) Species and strain sensitivity to the induction of peroxisome proliferation by chloroacetic acids. Toxicol Appl Pharmacol 101:285-298.

DeVivo, I; Marion, MJ; Smith, SJ; et al. (1994) Mutant c-Ki-ras protein in chemical carcinogenesis in humans exposed to vinyl chloride. Cancer Causes Control 5:273-278.

Donehower, LA; Harvey, M; Slagel, BL; et al. (1992) Mice deficient for p53 are developmentally normal but susceptible to spontaneous tumors. Nature 356:215-221.

Dosanjh, JK; Chenna, A; Kim, E; et al. (1994) All four known cyclic adducts formed in DNA by the vinyl chloride metabolite chloroacetaldehyde are released by a human DNA glycosylase. Proc Natl Acad Sci 91:1024-1028.

Doss, M; Lange, CE; Veltman, G. (1984) Vinyl chloride-induced hepatic coproporphyrinuria with transition to chronic hepatic porphyria. *Klin Wochenschr* 62:175-178.

Dow Chemical Company. (1986) Co-initial submission: an update of an epidemiologic study with vinyl chloride workers, 1942-1982 (final report with cover letter dated 07/24/92 and attachments). U.S. Environmental Protection Agency/OTS public files. Document no. 88-920005649. Fiche no. 0544432 (1).

Drew, RT; Boorman, GA; Haseman, JK; et al. (1983) The effect of age and exposure duration on cancer induction by a known carcinogen in rats, mice, and hamsters. *Toxicol Appl Pharmacol* 68:120-130.

D'Souza, RW; Andersen, ME. (1988) Physiologically based pharmacokinetic model for vinylidene chloride. *Toxicol Appl Pharmacol* 95:230-240.

Du, JL; Sandoz, JP; Tseng, MT; et al. (1979) Biochemical alterations in livers of rats exposed to vinyl chloride. *J Toxicol Environ Health* 5:1119-1132.

Du, CL; Kuo, ML; Chang, HL; et al. (1995) Changes in lymphocyte single strand breakage and liver function of workers exposed to vinyl chloride monomer. *Toxicol Lett (Ireland)* 77:379-385.

Duck, BW; Carter, JT; Coombes, EJ. (1975) Mortality study of workers in a polyvinyl-chloride production plant. *Lancet* 13:1197-1199.

Edmonds, LD; Anderson, CE; Flynt, JW, Jr; et al. (1978) Congenital central nervous system malformations and vinyl chloride monomer exposure: a community study. *Teratology* 17:137-142.

Elliot, P; Kleinschmidt, I. (1997) Angiosarcoma of the liver in Great Britain in proximity to vinyl chloride sites. *Occup Environ Med* 54:14-18.

Fedtke, N; Boucheron, JA; Walker, VE; et al. (1990) Vinyl chloride-induced DNA adducts. II. Formation and persistence of 7-(2'-oxoethyl)guanine and N<sup>2</sup>,3-ethenoguanine in rat tissue DNA. *Carcinogenesis* 11:1287-1292.

Feron, VJ; Kroes, R. (1979) One-year time-sequence inhalation toxicity study of vinyl chloride in rats. II. Morphological changes in the respiratory tract, ceruminous glands, brain, kidneys, heart, and spleen. *Toxicology* 13:131-141.

Feron, VJ; Hendriksen, CFM; Speek, AJ; et al. (1981) Lifespan oral toxicity study of vinyl chloride in rats. *Food Cosmet Toxicol* 19(3):317-333.

Filser, JG; Bolt, HM. (1979) Pharmacokinetics of halogenated ethylenes in rats. *Arch Toxicol* 42:123-136.

Fontana, L; Baietto, M; Becker, F; et al. (1995) Etude clinique et capillaroscopique de phenomenes de raynaud chez des retraites anciennement exposes au chlorure de vinyle monomere. *J Mal Vasculaires* 20:268-273.

Fox, AJ; Collier, PF. (1977) Mortality experience of workers' exposure to vinyl chloride monomer in the manufacture of polyvinyl chloride in Great Britain. *Br J Ind Med* 34:1-10.

Gargas, ML; Andersen, ME. (1982) Metabolism of inhaled brominated hydrocarbons: validation of gas uptake results by determination of a stable metabolite. *Toxicol Appl Pharmacol* 66:55-68.

Gedigk, P; Muller, R; Bechtelsheimer, H. (1975) Morphology of liver damage among polyvinyl chloride production workers. A report on 51 cases. *Ann NY Acad Sci* 246:279-285.

Gehring, PJ; Watanabe, PG; Park, CN. (1978) Resolution of dose-response toxicity data for chemicals requiring metabolic activation: example—vinyl chloride. *Toxicol Appl Pharmacol* 44:581-591.

- Goldsworthy, TL; Recio, L; Brown, K; et al. (1994) Symposium overview: transgenic animals in toxicology. *Fundam Appl Toxicol* 22:8-19.
- Green, T; Hathway, DE. (1975) Biological fate in rats of vinyl chloride in relation to its oncogenicity. *Chem-Biol Interact* 11:545-562.
- Greenblatt, MS; Bennett, WP; Hollstein, M; et al. (1994) Mutations in the p53 tumor suppressor gene: clues to cancer etiology and molecular pathogenesis. *Cancer Res* 54:4855-4878.
- Guengerich, FP. (1987) *Mammalian cytochromes P-450*. Vol. I. Boca Raton, FL: CRC Press, Inc.
- Guengerich, FP; Strickland, TW. (1977) Metabolism of vinyl chloride: destruction of the heme of highly purified liver microsomal cytochrome P-450 by a metabolite. *Molec Pharmacol* 13:993-1004.
- Guengerich, FP; Watanabe, PG. (1979) Metabolism of [<sup>14</sup>C]-labeled vinyl chloride *in vivo* and *in vitro*. *Biochem Pharmacol* 28:589-596.
- Guengerich, FP; Mason, PS; Stott, WT; et al. (1981) Roles of 2-haloethylene oxides and 2-haloacetaldehydes derived from vinyl bromide and vinyl chloride in irreversible binding to protein and DNA. *Cancer Res* 41:4391-4398.
- Guengerich, FP; Kim, D; Iwasaki, M. (1991) Role of human cytochrome P-450 IIE1 in the oxidation of many low molecular weight cancer suspects. *Chem Res Toxicol* 4:168-179.
- Gwinner, IM; Laib, RJ; Filser, JG; et al. (1983) Evidence of chloroethylene oxide being the reactive metabolite of vinyl chloride towards DNA: comparative studies with 2,2'-dichloroethylether. *Carcinogenesis* 4:1483-1486.
- Hansteen, IL; Hillestad, L; Thiis-Evensen, E; et al. (1978) Effects of vinyl chloride in man: a cytogenetic follow-up study. *Mutat Res* 51:271-278.
- Hatch, M; Kline, J; Stein, Z. (1981) Power considerations in studies of reproductive effects of vinyl chloride and some structural analogs. *Environ Health Perspect* 41:195-201.
- Hefner, RE, Jr; Watanabe, PG; Gehring, PJ. (1975) Preliminary studies of the fate of inhaled vinyl chloride monomer in rats. *Ann NY Acad Sci* 246:135-148.
- Hehir, RM; McNamara, BP; McLaughlin, J, Jr; et al. (1981) Cancer induction following single and multiple exposures to a constant amount of vinyl chloride monomer. *Environ Health Perspect* 41:63-72.
- Heldaas, SS; Langard, SL; Anderson, A. (1984) Incidence of cancer among vinyl chloride and polyvinyl chloride workers: further evidence for an association with malignant melanoma. *Br J Ind Med* 41:25-30.
- Hiatt, GFS; Cogliano, VJ; Becker, RA; et al. (1994) Vinyl chloride action levels: indoor air exposures at a Superfund site. In: *Hazardous waste and public Health: International Congress on the Health Effects of Hazardous Waste*. Andrews, JS, Jr; Frumkin, H; Johnson, BL; Mehlman, MA; Xintaras, C; Bucsela, JA, eds. Princeton, NJ: Princeton Scientific Publishing, pp. 525-529.
- Ho, SF; Phoon, WH; Gan, SL; et al. (1991) Persistent liver dysfunction among workers at a vinyl chloride monomer polymerization plant. *J Soc Occup Med* 41:10-16.
- Hong, CB; Winston, JM; Thornburg, LP; et al. (1981) Follow-up study on the carcinogenicity of vinyl chloride and vinylidene chloride in rats and mice: tumor incidence and mortality subsequent to exposure. *J Toxicol Environ Health* 7:909-924.



Infante, PF; Wagoner, JK; Waxweiler, RJ. (1976) Carcinogenic, mutagenic and teratogenic risks associated with vinyl chloride. *Mutat Res* 41:131-142.

Ivanetich, KM; Aronson, I; Katz, ID. (1977) The interaction of vinyl chloride with rat hepatic microsomal cytochrome P-450 in vitro. *Biochem Biophys Res Comm* 74:1411-1418.

Jaeger, RJ; Murphy, SD; Reynolds, ES; et al. (1977) Chemical modification of acute hepatotoxicity of vinyl chloride monomer in rats. *Toxicol Appl Pharmacol* 41:597-607.

Jedrychowski, RA; Sokal, JA; Chmielnicka, J. (1984) Influence of exposure mode on vinyl chloride action. *Arch Toxicol* 55:195-198.

Jedrychowski, RA; Sokal, JA; Chmielnicka, J. (1985) Comparison of the impact of continuous and intermittent exposure to vinyl chloride, including phenobarbital effects. *J Hyg Epidemiol Microbiol Immunol* 28:111-120.

John, JA; Smith, FA; Leong, BKJ; et al. (1977) The effects of maternally inhaled vinyl chloride on embryonal and fetal development in mice, rats, and rabbits. *Toxicol Appl Pharmacol* 39:497-513.

Jones, RW; Smith, DM; Thomas, PG. (1988) A mortality study of vinyl chloride monomer workers employed in the United Kingdom in 1940–1974. *Scand J Work Environ Health* 14:153-160.

Keplinger, ML; Goode, JW; Gordon, DE; et al. (1975) Interim results of exposure of rats, hamsters, and mice to vinyl chloride. *Ann NY Acad Sci* 248:219-224.

Krajewski, J; Dobecki, M; Gromiec, J. (1980) Retention of vinyl chloride in the human lung. *Br J Ind Med* 37:373-374.

Laib, RJ. (1986) The role of cyclic base adducts in vinyl-chloride-induced carcinogenesis: studies on nucleic acid alkylation in vivo. *IARC Sci Publ* 70:101-108.

Laib, RJ; Stoeckle, G; Bolt, HM; et al. (1979) Vinyl chloride and trichloroethylene. Comparison of alkylating effects of metabolites and induction of preneoplastic enzyme deficiencies in rat liver. *J Cancer Res Clin Oncol* 94:139-147.

Laib, RJ; Klein, KP; Bolt, HM. (1985) The rat liver foci bioassay. I. Age-dependence of induction by vinyl chloride of ATPase-deficient foci. *Carcinogenesis* 6:65-68.

Laib, RJ; Bolt, HM; Cartier, R; et al. (1989) Increased alkylation of liver DNA and cell turnover in young versus old rats exposed to vinyl chloride correlates with cancer susceptibility. *Toxicol Lett* 45:231-239.

Langauer-Lewowicka, H; Kurzbauer, H; Byczkowska, Z; et al. (1983) Vinyl chloride disease-neurological disturbances. *Int Arch Occup Environ Health* 52:151-157.

Lee, CC; Bhandari, JC; Winston, JM; et al. (1978) Carcinogenicity of vinyl chloride and vinylidene chloride. *J Toxicol Environ Health* 4:15-30.

Lee, FI; Smith, PM; Bennett, B; et al. (1996) Occupationally related angiosarcoma of the liver in the United Kingdom 1973-1994. *Gut* 39:312-318.

Leibman, KC. (1977) Current literature: metabolism of vinyl chloride. *Drug Metab Disp* 5:93-94.

Lelbach, WK. (1996) A 25-year follow-up study of heavily exposed vinyl chloride workers in Germany. *Am J Ind Med* 29:446-458.

Lester, D; Greenberg, LA; Adams, WR. (1963) Effects of single and repeated exposures of humans and rats to vinyl chloride. *Am Ind Hyg Assoc J* 24:265-275.

Lilis, R; Anderson, H; Nicholson, WJ; et al. (1975) Prevalence of disease among vinyl chloride and polyvinyl chloride workers. *Ann NY Acad Sci* 246:22-41.

Maltoni, C; Lefemine, G; Ciliberti, A; et al. (1980) Vinyl chloride carcinogenicity bioassays (BT project) as an experimental model for risk identification and assessment in environmental and occupational carcinogenesis. *Epidemiol Anim Epidemiol Hum: Cas Chlorure Vinyle Monomer (Reun. Club Carcerog. Chim.) 20th meeting date 1979, Publ. Essent, Paris, France, pp. 11-112.*

Maltoni, C; Lefemine, G; Ciliberti, A; et al. (1981) Carcinogenicity bioassay of vinyl chloride monomer: a model of risk assessment on an experimental basis. *Environ Health Perspect* 41:3-29.

Maltoni, C; Lefemine, G; Ciliberti, A; et al. (1984) Experimental research on vinyl chloride carcinogenesis. In: *Archives of research on industrial carcinogenesis. Vol. 2. Maltoni, C; Mehlman, MA, eds. Princeton, NJ: Princeton Scientific Publishers, Inc.*

Marion, MJ; DeVivo, I; Smith, S; et al. (1996) The molecular epidemiology of occupational carcinogenesis in vinyl chloride exposed workers. *Int Arch Occup Environ Health* 68:394-398.

Marsteller, HJ; Lelbach, WK; Muller, R; et al. (1975) Unusual splenomegalic liver disease as evidenced by peritoneoscopy and guided liver biopsy among polyvinyl chloride production workers. *Ann NY Acad Sci* 246:95-134.

Monson, RR; Peters, JM; Johnson, MN; et al. (1975) Proportional mortality among vinyl chloride workers. *Environ Health Perspect* 11:75-77.

Morinello, EJ; Ham, A-J; Swenberg, JA. (1999) Molecular dosimetry of N2,3-ethenoguanine in control and vinyl chloride-exposed rats. *Toxicol Sci* 48, Suppl 1:232.

Nakajima, T; Wang, R; Elovaara, E; et al. (1993) Cytochrome P450-related differences between rats and mice in the metabolism of benzene, toluene and trichloroethylene in liver microsomes. *Biochem Pharmacol* 45:1079-1085.

National Institute for Occupational Safety and Health (NIOSH), Public Health Service, U.S. Department of Health and Human Services. (1986) Chemical review: vinyl chloride. *Dangerous properties of industrial materials report 6:13-43. NIOSH publication no. 00188891. Washington, DC.*

National Research Council (NRC). (1983) *Risk assessment in the federal government: managing the process.* Washington, DC: National Academy Press.

Occidental Chemical Corporation. (1975) Initial submission: Pottstown vinyl chloride medical survey results (final report with attachments and cover letter dated 02/21/92). U.S. Environmental Protection Agency/OTS public files (8eCP). Document no. 88-920001077. Fiche no. 0535773.

Ott, MG; Langner, RR; Holder, BB. (1975) Vinyl chloride exposure in a controlled industrial environment. *Arch Environ Health* 30:333-339.

Perrard, MH. (1985) Mutagenicity and toxicity of chloroethylene oxide and chloroacetaldehyde. *Experientia* 41:676-677.

Perticoni, GF; Abbritti, G; Cantsani, TA; et al. (1986) Polyneuropathy in workers with long exposure to vinyl chloride. Electrophysiological study. *Electromyogr Clin Neurophysiol* 26:41-47.

- Pessayre, D; Wandscheer, JC; Descatoire, V; et al. (1979) Formation and inactivation of a chemically reactive metabolite of vinyl chloride. *Toxicol Appl Pharmacol* 49:505-515.
- Pirastu, R; Comba, P; Reggiani, A; et al. (1990) Mortality from liver disease among Italian vinyl chloride monomer/polyvinyl chloride manufacturers. *Am J Ind Med* 17:155-161.
- Plugge, H; Safe, S. (1977) Vinyl chloride metabolism—a review. *Chemosphere* 6:309-325.
- Popper, H; Thomas, LB. (1975) Alterations of liver and spleen among workers exposed to vinyl chloride. *Ann NY Acad Sci* 246:172-194.
- Purchase, IFH; Richardson, CR; Anderson, D; et al. (1978) Chromosomal analysis in vinyl chloride exposed workers. *Mutat Res* 57:325-334.
- Ramsey, JR; Andersen, ME. (1984) A physiologically based description of the inhalation pharmacokinetics of styrene in rats and humans. *Toxicol Appl Pharmacol* 73:159-175.
- Rannug, U; Johansson, A; Ramel, C; et al. (1974) The mutagenicity of vinyl chloride after metabolic activation. *Ambio* 3:194-197.
- Rannug, U; Gothe, R; Wachtmeister, CA. (1976) The mutagenicity of chloroethylene oxide, chloro-acetaldehyde, 2-chloroethanol and chloroacetic acid, conceivable metabolites of vinyl chloride. *Chem Biol Interact* 12:251-263.
- Reitz, RH; Gargas, ML; Andersen, ME; et al. (1996) Predicting cancer risk from vinyl chloride exposure with a physiologically based pharmacokinetic model. *Toxicol Appl Pharmacol* 137:253-267.
- Reynolds, ES; Moslen, MT; Szabo, S; et al. (1975) Vinyl chloride-induced deactivation of cytochrome P-450 and other components of the liver mixed function oxidase system: an in vivo study. *Res Comm Chem Pathol Pharmacol* 12:685-694.
- Sandgren, EP; Quaiife, CJ; Pinkert, CA; et al. (1989) Oncogene-induced liver neoplasia in transgenic mice. *Oncogene* 4:715-724.
- Sax, NI; Lewis, RJ, eds. (1989) *Dangerous properties of industrial materials*. 7th ed. New York: Van Nostrand Reinhold Co., pp. 3473-3474.
- Schoental, R; Magee, PN. (1957) Chronic liver changes in rats after a single dose of lasiocarpine, a pyrrolizidine (*Senecio*) alkaloid. *J Pathol Bact* 74:305-319.
- Schoental, R; Magee, PN. (1959) Further observations on the subacute and chronic liver changes in rats after a single dose of various pyrrolizidine (*Senecio*) alkaloids. *J Pathol Bact* 78:471-482.
- Short, RD; Minor, JL; Winston, JM; et al. (1977) Dominant lethal study in male rats after repeated exposures to vinyl chloride or vinylidene chloride. *J Toxicol Environ Health* 3:965-968.
- Simonato, L; L'Abbe, KA; Andersen, A; et al. (1991) A collaborative study of cancer incidence and mortality among vinyl chloride workers. *Scand J Work Environ Health* 17:159-169.
- Singer, B. (1985) In vivo formation and persistence of modified nucleosides resulting from alkylating agents. *Environ Health Perspect* 62:41-48.
- Singer, B; Spengler, SJ; Chavez, F; et al. (1987) The vinyl chloride-derived nucleoside, N<sup>2</sup>,3-ethenoguanosine, is a highly efficient mutagen in transcription. *Carcinogenesis* 8:745-747.

- Sinues, B; Sanz, A; Bernal, ML. (1991) Sister chromatid exchanges, proliferating rate index, and micronuclei in biomonitoring of internal exposure to vinyl chloride monomer in plastic industry workers. *Toxicol Appl Pharmacol* 108:37-45.
- Sipes, IG; Gandolfi, AJ. (1991) Biotransformation of toxicants. In Casarett and Doull's *Toxicology*, 4<sup>th</sup> ed. Klasson, CD; Amdur, MO; Doull, J, eds. McGraw Hill, New York, NY. pp 88-126.
- Smulevich, VB; Fedotova, IV; Filatova, VS. (1988) Increasing evidence of the rise of cancer in workers exposed to vinyl chloride. *Br J Ind Med* 45:93-97.
- Sokal, JA; Baranski, B; Majka, J; et al. (1980) Experimental studies on the chronic toxic effects of vinyl chloride in rats. *J Hyg Epidemiol Microbiol Immunol* 24:285-294.
- Studniarek, M; Durski, K; Liniecki, J; et al. (1989) Effects of vinyl chloride on liver function of exposed workers, evaluated by measurements of plasma clearance of the 99mTc-N-2,4-dimethylacetanilido-iminodiacetate complex. *J Appl Toxicol* 9:213-218.
- Suzuki, Y. (1978) Pulmonary tumors induced in mice by vinyl chloride monomer. *Environ Res* 16:285-301.
- Suzuki, Y. (1983) Neoplastic effect of vinyl chloride in mouse lung—lower doses and short-term exposure. *Environ Res* 32:91-103.
- Swenberg, JA; Fedtke, N; Ciroussel, F; et al. (1992) Etheno adducts formed in DNA of vinyl chloride-exposed rats are highly persistent in liver. *Carcinogenesis* 13:727-729.
- Tabershaw, IR; Gaffey, WR. (1974) Mortality study of workers in the manufacture of vinyl chloride and its polymers. *J Occup Med* 16:509-518.
- Tamburro, CH; Makk, L; Popper, H. (1984) Early hepatic histologic alterations among chemical (vinyl monomer) workers. *Hepatology* 4:413-418.
- Tarkowski, S; Wisniewska-Knypl, JM; Klimczak, J; et al. (1980) Urinary excretion of thiodiglycolic acid and hepatic content of free thiols in rats at different levels of exposure to vinyl chloride. *J Hyg Epidemiol Microbiol Immunol* 24:253-261.
- Tennant, RW; French, JE; Spalding, JW. (1995) Identifying chemical carcinogens and assessing potential risk in short-term bioassays using transgenic mouse models. *Environ Health Perspect* 103:942-950.
- Theriault, G; Iturra, H; Gingras, S. (1983) Evaluation of the association between birth-defects and exposure to ambient vinyl-chloride. *Teratology* 27:359-370.
- Til, HP; Immel, HR; Feron, VJ. (1983) Lifespan oral carcinogenicity study of vinyl chloride in rats. Report no. V 83f.285/291099. Zeist, The Netherlands: Civo Institutes TNO.
- Til, HP; Feron, VJ; Immel, HR. (1991) Lifetime (149-week) oral carcinogenicity study of vinyl chloride in rats. *Fd Chem Toxicol* 29:713-718.
- Torkelson, TR; Oyen, F; Rowe, VK. (1961) The toxicity of vinyl chloride as determined by repeated exposure of laboratory animals. *Am Ind Hyg Assoc J* 22:354-361.
- Trivers, GE; Cawley, HL; DeBenedetti, VMG; et al. (1995) *J Natl Cancer Inst* 87:1400-1407.

Ungvary, G; Hudak, A; Tatrai, E; et al. (1978) Effects of vinyl chloride exposure alone and in combination with trypan blue applied systematically during all thirds of pregnancy on the fetuses of CFY rats. *Toxicology* 11(1):45-54.

U.S. Environmental Protection Agency. (1985) Drinking water criteria document for vinyl chloride. Washington, DC. Prepared by the Office of Health and Environmental Assessment, Environmental Criteria and Assessment Office, Cincinnati, OH, for the Office of Drinking Water, NTIS PB86-118320.

U.S. Environmental Protection Agency. (1986) Guidelines for carcinogen risk assessment. *Federal Register* 51(185):33992-43003.

U.S. Environmental Protection Agency. (1987) Risk assessment guidelines of 1986. Office of Health and Environmental Assessment, Washington, DC. EPA/600/8-87/045, dated August 1987.

U.S. Environmental Protection Agency. (1988, Feb) Recommendations for and documentation of biological values for use in risk assessment. Office of Health and Environmental Assessment, Washington, DC. EPA 600/6-87/800. NTIS PB88-179874/AS.

U.S. Environmental Protection Agency. (1991, Dec. 5) Guidelines for developmental toxicity risk assessment. *Federal Register* 56(234):63798-63826.

U.S. Environmental Protection Agency. (1992) Request for comments on draft report of cross-species scaling factor for cancer risk assessment. *Federal Register* 57:24152.

U.S. Environmental Protection Agency. (1994a, Oct. 26) Interim policy for particle size and limit concentration issues in inhalation toxicity: notice of availability. *Federal Register* 59(206):53799.

U.S. Environmental Protection Agency. (1994b, Oct. 26) Methods for derivation of inhalation reference concentrations and application of inhalation dosimetry. EPA/600/8-90/066F. Prepared by the Office of Health and Environmental Assessment, Environmental Criteria and Assessment Office, Cincinnati, OH.

U.S. Environmental Protection Agency. (1994c) Peer review and peer involvement at the U.S. Environmental Protection Agency, signed by U.S. EPA Administrator, Carol M. Browner, dated June 7, 1994.

U.S. Environmental Protection Agency. (1994d) Health effects assessment summary tables FY 1994: supplement number 2. Prepared by the Office of Health and Environmental Assessment, Environmental Criteria and Assessment Office, Cincinnati, OH. Washington, DC. EPA/540/R/94-114. NTIS PB94-921102.

U.S. Environmental Protection Agency. (1995a) Guidance on risk characterization. Memorandum of the U.S. EPA Administrator, Carol Browner, dated March 21, 1995.

U.S. Environmental Protection Agency. (1995b, Oct. 4) Proposed guidelines for neurotoxicity risk assessment. *Federal Register* 60(192):52032-52056.

U.S. Environmental Protection Agency. (1995c, Feb.) Use of the benchmark dose approach in health risk assessment. Prepared by the Office of Health and Environmental Assessment, Environmental Criteria and Assessment Office, Cincinnati, OH. EPA/630/R-94/007.

U.S. Environmental Protection Agency. (1996) Proposed guidelines for carcinogen risk assessment. Office of Research and Development. *Federal Register* 61(79):17960-18011.

Viola, PL. (1970) Pathology of vinyl chloride. *Med Lav* 61:174-180.

Viola, PL; Bigotti, A; Caputo, A. (1971) Oncogenic response of rats' skin, lungs, and bones to vinyl chloride. *Cancer Res* 31:516-522.

- Wallis, SAS; Holmberg, B; Svensson, K; et al. (1988) Induction of single-strand breaks in liver DNA of mice after inhalation of vinyl chloride. *IARC Sci Publ* 89:227-231.
- Watanabe, PG; Gehring, PJ. (1976) Dose-dependent fate of vinyl chloride and its possible relationship to oncogenicity in rats. *Environ Health Perspect* 17:145-152.
- Watanabe, PG; McGowan, GR; Gehring, PJ. (1976a) Fate of [<sup>14</sup>C]-vinyl chloride after single oral administration in rats. *Toxicol Appl Pharmacol* 36:339-352.
- Watanabe, PG; McGowan, GR; Madrid, EO; et al. (1976b) Fate of [<sup>14</sup>C]-vinyl chloride following inhalation exposure in rats. *Toxicol Appl Pharmacol* 37:49-59.
- Watanabe, PG; Hefner, RE, Jr; Gehring, PJ. (1976c) Vinyl chloride-induced depression of hepatic non-protein sulfhydryl content and effects on bromosulphalein (BSP) clearance in rats. *Toxicology* 6:1-8.
- Watanabe, PG; Zempel, JA; Peggy, DG; et al. (1978) Hepatic macromolecular binding following exposure to vinyl chloride. *Toxicol Pharmacol* 44:571-579.
- Waxweiler, RJ; Stringer, W; Wagoner, JK; et al. (1976) Neoplastic risk among workers exposed to vinyl chloride. *Ann NY Acad Sci* 271:40-48.
- Waxweiler, RJ; Falk, H; McMichael, A; et al. (1977) A cross-sectional epidemiologic survey of vinyl chloride workers. NTIS PB274193. Springfield, VA.
- Waxweiler, RJ; Smith, AH; Falk, H; et al. (1981) Excess lung cancer risk in a synthetic chemicals plant. *Environ Health Perspect* 41:159-165.
- Weber, H; Reinl, W; Greiser, E. (1981) German investigations on morbidity and mortality of workers exposed to vinyl chloride. *Environ Health Perspect* 41:95-99.
- Whysner, J; Conaway, CC; Verna, L; et al. (1996) Vinyl chloride mechanistic data and risk assessment: DNA reactivity and cross-species quantitative risk extrapolation. *Pharmacol Ther* 71:7-28.
- Wisniewska-Knypl, J; Klimczak, J; Kolakowski, J. (1980) Monooxygenase activity and ultrastructural changes of liver in the course of chronic exposure of rats to vinyl chloride. *Int Arch Occup Environ Health* 46(3):241-249.
- Withey, JR. (1976) Pharmacodynamics and uptake of vinyl chloride monomer administered by various routes to rats. *J Toxicol Environ Health* 1:381-394.
- Wong, O; Whorton, MD; Foliart, DE; et al. (1991) An industry-wide epidemiologic study of vinyl chloride workers, 1942-1982. *Am J Ind Med* 20:317-334.
- Wu, W; Steenland, K; Brown, D; et al. (1989) Cohort and case-control analyses of workers exposed to vinyl chloride: an update. *J Occup Med* 31:518-523.
- Zajdela, F; Croisy, A; Barbin, A; et al. (1980) Carcinogenicity of chloroethylene oxide, an ultimate reactive metabolite of vinyl chloride, and Bis(chloromethyl)ether after subcutaneous administration and in initiation-promotion experiments in mice. *Cancer Res* 40:352-356.

## APPENDIX A. COMPARISON OF PBPK MODELS FOR VINYL CHLORIDE

The calculations performed in this risk assessment used the PBPK model of Clewell et al. (1995a). Another model of vinyl chloride (VC) was recently published (Reitz et al., 1996). The purpose of this Appendix is to provide a comparison of the two models and to demonstrate the similarity of risk calculations based on either model. For comparison purposes, tumor incidences were based on liver angiosarcoma only.

### A.1. REVIEW OF REPORTED PBPK MODELS FOR VC

In fact, five different PBPK models for VC have been described in the literature. The first (Chen and Blancato, 1989) was a simple description of parent chemical kinetics and total metabolism based on the styrene model of Ramsey and Andersen (1984). Metabolism of VC was modeled with a single saturable pathway, and the kinetic constants were estimated from measurements of whole body clearance (e.g., Filser and Bolt, 1989). No attempt was made to validate the model against data on blood time-courses or total metabolism. The model was used to calculate total metabolism of VC (representing total production of reactive metabolites) as the dose metric in a carcinogenic risk assessment for VC. Potency estimates based on the internal dose (mg VC metabolized per kg/day) were derived from inhalation bioassays of VC performed by Maltoni et al. (1981, 1984), as well as from human epidemiological data. Using the same internal dose metric (mg metabolized per kg/day), the inhalation potency estimated from epidemiological data of Fox and Collier (1977) of  $3.8 \times 10^{-3}/\text{ppm}$  ( $1.4 \times 10^{-6}$  per  $\mu\text{g}/\text{m}^3$ ) was essentially identical to the potency estimated from rat inhalation data of  $1.7 - 3.7 \times 10^{-3}/\text{ppm}$  ( $0.7 - 1.4 \times 10^{-6}$  per  $\mu\text{g}/\text{m}^3$ ) using body weight scaling (that is, without applying a body surface area correction for cross-species scaling). Although the extrapolations performed by Chen and Blancato were for carcinogenic risk, the PBPK model would be equally effective for noncancer endpoints.

The second model published for VC (Gargas et al., 1990) was a generic model of volatile chemical kinetics in a recirculated closed chamber, which was used to identify global metabolic parameters in the rat for a number of chemicals, including VC. It differed from the model of Chen and Blancato chiefly by the incorporation of a second, linear metabolic pathway (presumed to be glutathione conjugation) in parallel with the saturable (oxidative) pathway. Based on gas uptake studies, both a saturable and a linear metabolic component were postulated for VC.

The different descriptions of metabolism in the two models discussed above were examined in a more in-depth study of VC pharmacokinetics performed for the U.S. Air Force by the K.S. Crump Division of Clement International (Clement, 1990). They refitted the one- and two-pathway descriptions to gas uptake data and then compared their predictions with measurements of total metabolism by Gehring et al. (1978) and Watanabe et al. (1976b). Although the two-pathway description provided a significantly better fit to the gas uptake data (adding parameters nearly always improves a fit), the resulting parameters tended to overpredict total metabolism at higher concentrations owing to the presence of the first-order component. In addition, it was not possible to explain the continued increase in glutathione (GSH) depletion measured at the highest exposure levels (where the saturable component was above saturation)

because only products of the oxidative metabolism of VC have been shown to react with GSH. In an attempt to provide a better correspondence to the data on both total metabolism and glutathione depletion, two possible refinements to the model were investigated. In the first, direct reaction of VC with GSH was postulated, and in the second, the products of both the saturable and the linear pathways were assumed to react with GSH. Unfortunately, neither description was able to provide a satisfactory correspondence to both total metabolism and GSH depletion data. The authors suggested that a different formulation featuring two saturable oxidative pathways, both producing reactive metabolites, might provide the required behavior. This suggestion formed the basis for the subsequent development of the PBPK model of Clewell et al. (1995a).

More recently, a PBPK model of VC was developed by Reitz et al. (1996) and applied to compare cancer potency in mice, rats, and humans. The structure of the model was similar to that of Chen and Blancato (1989), providing a description of parent chemical kinetics and total metabolism based on the styrene model of Ramsey and Andersen (1984). Metabolism of VC was modeled with a single saturable pathway, and the kinetic constants were estimated from fitting of closed chamber gas uptake studies with rats. The model was then validated against data on total metabolism in the rat (Watanabe et al., 1976b), gas uptake data in the mouse, and inhalation data in the human (Baretta et al., 1969). The model was used to calculate total metabolism of VC as the dose metric in carcinogenic risk assessments for VC. Based on the rat inhalation bioassay of Maltoni et al. (1981, 1984), and using the linearized multistage model, they estimated that lifetime continuous human exposure to 1.75  $\mu\text{g}$  VC is associated with an increased lifetime risk of one in a million. This estimate equates to a lifetime risk of approximately  $0.6 \times 10^{-6}/\mu\text{g}/\text{m}^3$ , in good agreement with the results of Chen and Blancato (1989). The potency estimates from rats were then shown to be consistent with tumor incidence data in mice and humans when the pharmacokinetic dose metric was used.

In a parallel effort, a more elaborate PBPK model of VC was developed for OSHA and EPA to support a cancer risk assessment for VC (Clewell et al., 1995a). This model and the modeling results are described in more detail in Appendix B. Following the suggestion of Clement (1990), the initial metabolism of VC was hypothesized to occur via two saturable pathways, one representing low-capacity–high-affinity oxidation by CYP2E1 and the other representing higher capacity–lower affinity oxidation by other isozymes of P450, producing in both cases chloroethylene oxide (CEO) as an intermediate product. The percentage of CEO converted to  $\text{CO}_2$  via reaction with  $\text{H}_2\text{O}$  was determined from published reports of radiolabeled VC whole-body metabolism studies. Previous *in vitro* and *in vivo* studies support chloroacetaldehyde (CAA) as the major metabolite of VC through the breakdown of CEO, and this metabolite was modeled as the major substrate in glutathione (GSH) conjugation, with a lesser amount of CEO as the glutathione S-epoxide transferase substrate. Depletion of glutathione by reaction with CAA was also described. The parameter values for the two metabolic pathways describing the initial step in VC metabolism were determined by simulation of gas uptake data from mice, rats, hamsters, monkeys, and controlled human inhalation exposures, as well as from data on total metabolism and glutathione depletion in both oral and inhalation exposures of rats. The use of a low-affinity pathway in parallel with the high-affinity pathway was able to successfully reproduce the continued increases in total metabolism and GSH depletion observed with VC in rats. The successful simulation of pharmacokinetic data from a large number of



studies over a wide range of concentrations, using multiple routes of exposure, served as evidence that the PBPK model was valid over the exposure range of interest.

As with the PBPK model of Chen and Blancato (1989), the use of a pharmacokinetic dose metric reflecting lifetime average daily dose to the target tissue resulted in similar potency estimates for liver angiosarcoma from VC across different species. The human risk estimates based on studies with mice ( $0.6 \times 10^{-6}$  to  $1.3 \times 10^{-6}$  per  $\mu\text{g}/\text{m}^3$ ) agreed very well with those based on inhalation studies with rats ( $0.9 \times 10^{-6}$  to  $2.1 \times 10^{-6}$  per  $\mu\text{g}/\text{m}^3$ ) demonstrating the ability of pharmacokinetics to integrate dose-response information across species. It should be noted that these were values derived using liver angiosarcoma incidence only and before a sixfold factor is incorporated. Lifetime risk of liver cancer from VC exposure estimated from three epidemiological studies was  $2.7 \times 10^{-7}$  to  $1.6 \times 10^{-6}$  per  $\mu\text{g}/\text{m}^3$ , in good agreement with the estimates based on animal inhalation data. The risk estimates obtained with this model are also very similar to those obtained with the simpler PBPK models of Chen and Blancato (1989) and Reitz et al. (1996), as described above. It should be noted, however, that human exposure estimates have a considerable degree of uncertainty, so agreement may be at least to some extent due to chance.

The human inhalation risks were somewhat greater when estimated using data from female rats exposed orally to VC in the Feron et al. (1981) study. These estimates ranged from  $3.1 \times 10^{-6}$  when based on angiosarcomas alone to  $1.2 \times 10^{-4}$  per  $\mu\text{g}/\text{m}^3$  when based on all liver tumors including angiosarcomas, hepatocellular carcinomas, and neoplastic nodules. These estimates were in general agreement with those derived from female rats using the oral bioassays of Maltoni et al. (1981, 1984),  $1.7 \times 10^{-5}$  per  $\mu\text{g}/\text{m}^3$ . Human cancer potency estimates based on oral exposure are unavailable, because ingestion is not a common route of human exposure. It is quite possible, however, that potency for induction of liver cancer is somewhat greater by the oral route of exposure, because essentially all absorbed VC passes through the liver before entering the systemic circulation, whereas some of the VC taken up through the lungs may be metabolized by other tissues before reaching the liver.

In summary, the results of pharmacokinetic risk assessments using three different PBPK models are in remarkable agreement, with lifetime risk estimates for different species exposed via the inhalation route that range over about an order of magnitude, from  $0.2 \times 10^{-6}$  to  $2 \times 10^{-6}$  per  $\mu\text{g}/\text{m}^3$ . These pharmacokinetic risk estimates are lower than those currently used in environmental decision making by roughly two orders of magnitude. The currently used risk estimates, however, are in much closer agreement with those obtained in the present study by the oral route, differing by only four- to fivefold. The simpler PBPK models of Chen and Blancato (1989) or Reitz et al. (1996) would provide an acceptable framework for conducting a pharmacokinetically based human risk assessment for VC, and would provide a more accurate estimate of human risk than external measures of VC exposure. However, the 2-saturable pathway model structure used by Clewell et al. (1995a) is better validated, because, in addition to the data used to validate the other models, it was validated against experimental data on both total metabolism and GSH depletion in rats as well as closed-chamber VC exposure data in humans.

## A.2. COMPARISON OF REITZ AND CLEWELL MODELS

A more complete comparison was performed between the model used in this risk assessment and the recently published model of Reitz et al. (1996). The structures of the two models are shown in Figures A-1 and A-2.<sup>1</sup> It can be seen that the structure of the parent chemical portion of the models is essentially identical. Only the descriptions of metabolism in the two models differ substantially. The model of Clewell et al. (1995a) includes a more complex description of metabolism, with two saturable oxidative pathways rather than one, and with a description of glutathione conjugation of the oxidative metabolites. The purpose of this additional complexity was (1) to increase confidence in the ability of the model to correctly simulate VC metabolism by improving the ability of the model to reproduce data on the dose response for total metabolism and glutathione depletion in rats, and (2) to investigate alternative dose metrics representing (a) total oxidative metabolites not detoxified by glutathione and (b) total glutathione conjugates. As reported in Clewell et al. (1995a), the alternative dose metrics did not provide any improvement over the use of total metabolism and were not used or presented in the risk assessment. The model components associated with the formation of glutathione conjugates and the depletion of glutathione do not have any effect on the calculation of total oxidative metabolism in the model. Therefore, for the calculation of risks based on liver metabolism dose metrics, the only structural difference between the two models is the use of one versus two saturable pathways to describe metabolism.

The parameters used in the two models are shown in Tables A-1 and A-2.<sup>2</sup> Of the physiological parameters, the only significant differences are in the alveolar ventilation for the human, the liver volume for the rat, and the body weight and fat volumes for the rat and mouse. The Clewell et al. (1995a) model used an alveolar ventilation based on the EPA's preferred human ventilation rate (20 m<sup>3</sup>/day), based on continuous heavy work, whereas the ventilation rates in the Reitz et al. (1996) model were taken from the International Radiation Consensus Report on Reference man and were more typical of humans at rest or engaged in light activity. The rat liver volumes used were recommended in the recent ILSI Risk Science Institute physiological parameter document (ILSI, 1994), whereas the Reitz et al. (1996) model used actual necropsy results. The Clewell et al. model also used the actual animal body weights reported by the authors of the bioassays, and calculated the fat volume from the observed relationship between body weight and fat volume in the rodent (ILSI, 1994). The blood/air and tissue/blood partition coefficients in the two models are for the most part similar, but the slowly perfused tissue/blood partition coefficients in the Reitz et al. model are as much as threefold higher than those in the Clewell et al. model. Metabolic parameters also differ somewhat between the two models, reflecting the different data sets used to estimate metabolism in different species, strains, and sexes.

---

<sup>1</sup>For the purpose of this comparison, it was necessary to add oral uptake to the model of Reitz et al. (1996), which includes only inhalation exposure. This was accomplished by adding a zero-order input term in the equation for the liver, in the same fashion as in the model of Clewell et al. (1996b).

<sup>2</sup>The parameter values for the Reitz et al. (1996) model are taken from Table 1 of that publication with the exception of the blood/air partition coefficient in the mouse, which was incorrectly reported as 2.26. The value shown in Table A-1 is the value actually used in the risk calculations (R.H. Reitz, personal communication).

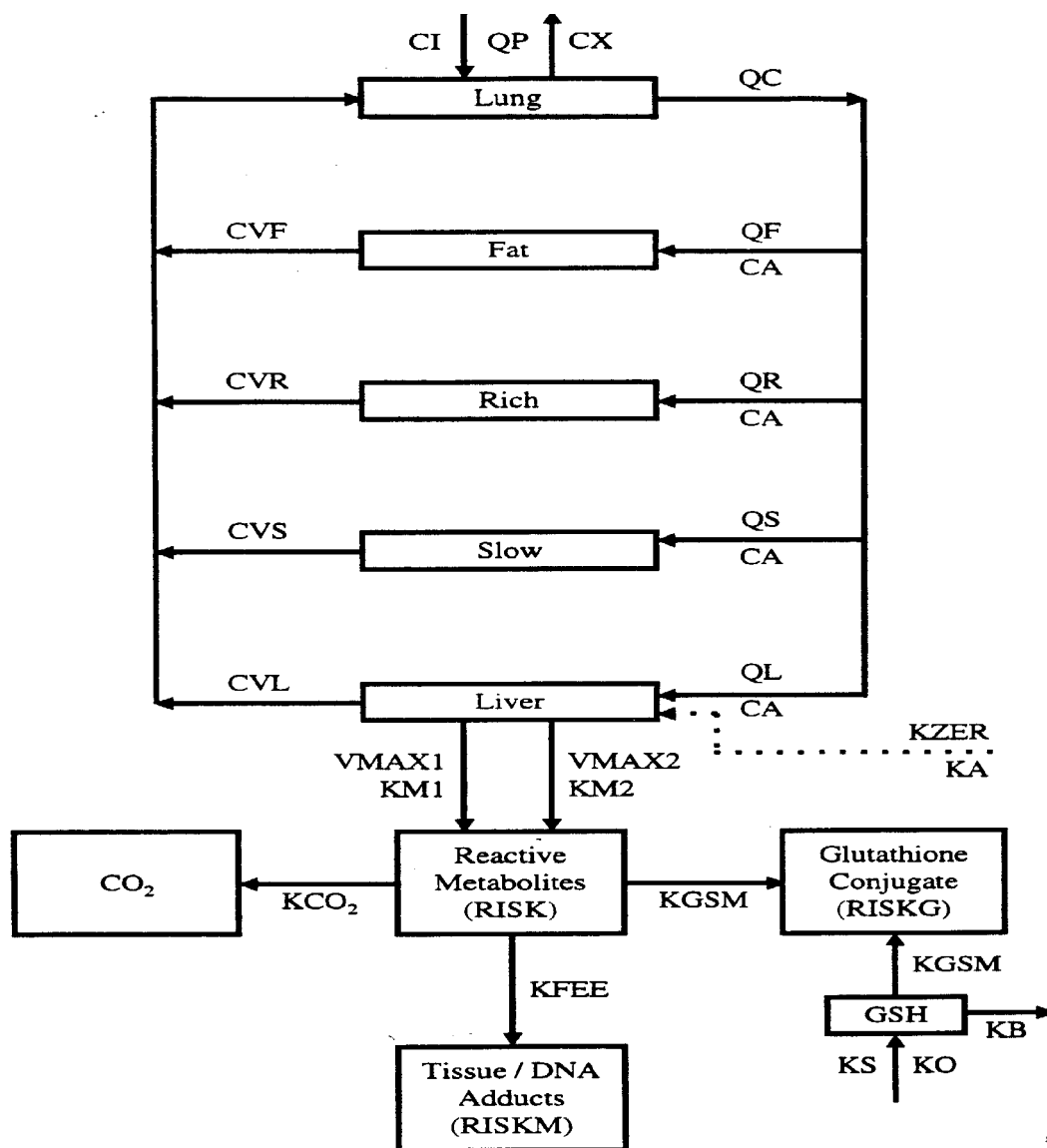
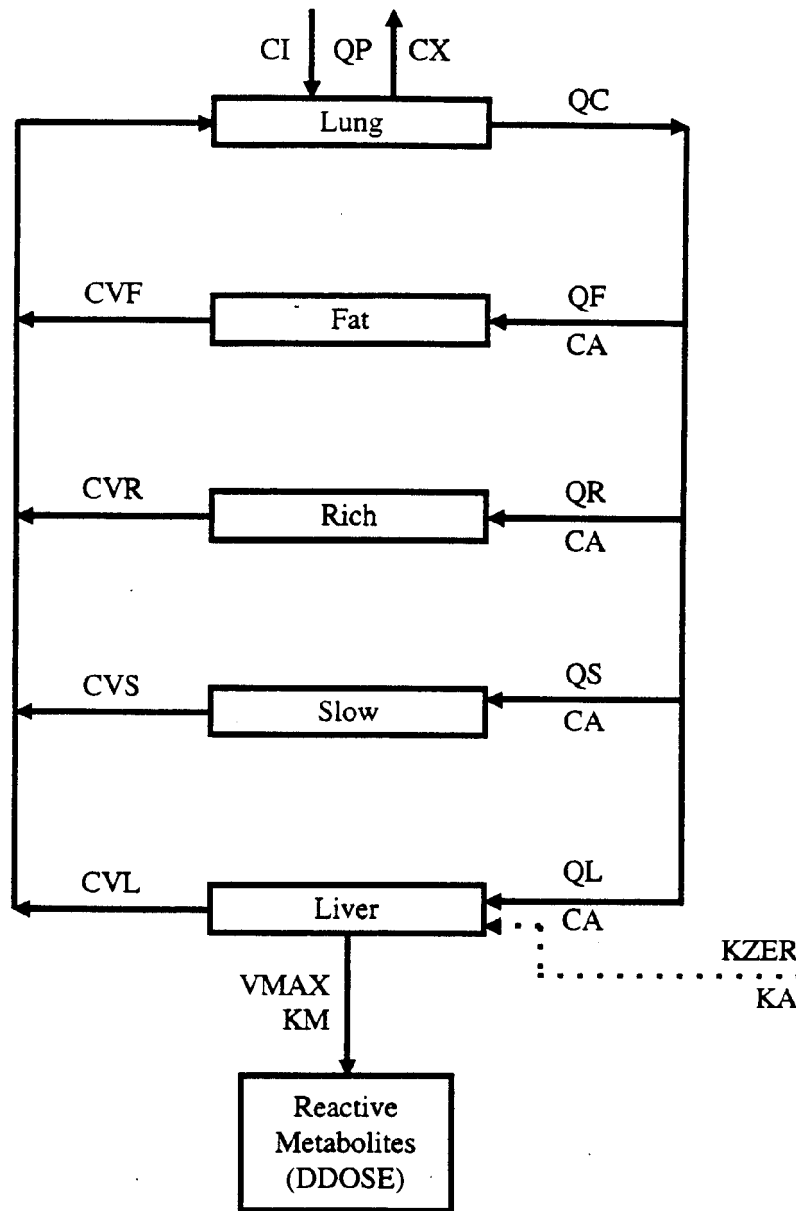

Figure A-1. The PBPK model for vinyl chloride developed by Clewell et al. (1995a). Diagram of the PBPK model of Clewell et al. (1995a) for VC. Abbreviations: QP = alveolar ventilation; CI = inhaled concentration; CX = exhaled concentration; QC = cardiac output; QF, CVF = blood flow to, and venous concentration leaving, the fat; QR, CVR = blood flow to, and venous concentration leaving, the richly perfused tissues (most organs); QS, CVS = blood flow to, and venous concentration leaving, the slowly perfused tissues (e.g., muscle); QL, CVL = blood flow to, and venous concentration leaving, the liver; VMAX1, KM1 = capacity and affinity for the high-affinity oxidative pathway enzyme (CYP 2E1); VMAX2, KM2 = capacity and affinity for the lower affinity oxidative pathway enzymes (e.g., CYP 2C11/6); KZER = zero-order rate constant for uptake of VC from drinking water; KA = first-order rate constant for uptake of VC from corn oil; KCO<sub>2</sub> = first-order rate constant for metabolism of VC to CO<sub>2</sub>; KGSM = first-order rate constant for reaction of VC metabolites with GSH; KFEE = first-order rate constant for reaction of VC metabolites with other cellular materials, including DNA; KB = first-order rate constant for normal turnover of GSH; KO = zero-order rate constant for maximum production of GSH; KS = parameter controlling rate of recovery of GSH from depletion.



**Figure A-2**

Figure A-2. Diagram of the PBPK model of Reitz et al. (1996) for VC. Abbreviations are as in Figure A-1.

**Table A-1. Comparison of model parameters**

		Mouse		Rat		Human	
		Clewell	Reitz	Clewell	Reitz	Clewell	Reitz
BW	Body weight (kg)	0.040-0.044 <sup>c</sup>	0.0285	0.245-0.638 <sup>a</sup>	0.225	70.0	70.0
	Scaling factor	0.75	0.74 <sup>d</sup>	0.75	0.74 <sup>b</sup>	0.75	0.74 <sup>b</sup>
QPC	Alveolar ventilation (L/hr)	30.0	28.0	21.0	18.0	24.0	15.0
QCC	Cardiac output (L/hr)	18.0	28.0	18.0	18.0	16.5	15.0
Tissue blood flows (fraction of cardiac output):							
QRC	Rapidly perfused tissues	0.51	0.52	0.51	0.52	0.5	0.52
QFC	Fat	0.09	0.05	0.09	0.05	0.05	0.05
QSC	Slowly perfused tissues	0.15	0.19	0.15	0.19	0.19	0.19
QLC	Liver	0.25	0.24	0.25	0.24	0.26	0.24
Tissue volumes (fraction of body weight):							
VSC	Slow	0.77	0.7614	0.75	0.7647	0.63	0.6105
VFC	Fat	0.12-0.13 <sup>a</sup>	0.04	0.11-0.20 <sup>a</sup>	0.07	0.19	0.231
VRC	Rapid	0.035	0.05	0.05	0.05	0.064	0.0371
VLC	Liver	0.055	0.0586	0.04	0.0253	0.026	0.0314
Partition coefficients:							
PB	Blood/air	2.26	2.26 <sup>e</sup>	2.4	1.68	1.16	1.16
PF	Fat/blood	10.62	8.85 <sup>f</sup>	10.0	11.9 <sup>c</sup>	20.7	17.2 <sup>c</sup>
PS	Slow/blood	0.42	0.93 <sup>c</sup>	0.4	1.25 <sup>c</sup>	0.83	1.81 <sup>c</sup>
PR	Rapid/blood	0.74	0.71 <sup>c</sup>	0.7	0.95 <sup>c</sup>	1.45	1.38 <sup>c</sup>
PL	Liver/blood	0.74	0.71 <sup>c</sup>	0.7	0.95 <sup>c</sup>	1.45	1.38 <sup>c</sup>
Metabolic parameters:							
VMAX1C	Maximum velocity of first saturable pathway (mg/hr)	5.0-8.0 <sup>c</sup>	8.13	3.0-4.0 <sup>a</sup>	2.75	4.0	3.97
KM1	Affinity of first saturable pathway (mg/L)	0.1	0.28	0.1	0.04	1.0	0.04

**Table A-1. Comparison of model parameters (continued)**

		Mouse		Rat		Human	
		Clewell	Reitz	Clewell	Reitz	Clewell	Reitz
VMAX2C	Maximum velocity of second saturable pathway (mg/hr)	0.1-3.0 <sup>a</sup>	0.0	0.1-2.0 <sup>a</sup>	0.0	0.1	0.0
KM2	Affinity of second saturable pathway (mg/L)	10.0	— <sup>g</sup>	10.0	—	10.0	—
GSH parameters:							
KCO2C	First-order breakdown to CO <sub>2</sub>	1.6	—	1.6	—	1.6	—
KGSMC	Conjugation rate constant	0.13	—	0.13	—	0.13	—
KFEEC	Rate constant with non-GSH	35.0	—	35.0	—	35.0	—
GSO	Initial GSH concentration	5800.0	—	5800.0	—	5800.0	—
KBC	First-order rate constant for GSH breakdown	0.12	—	0.12	—	0.12	—
KS	Resynthesis constant	2000.0	—	2000.0	—	2000.0	—
KOC	Zero-order production of GSH	28.5	—	28.5	—	28.5	—
Dosing parameters:							
KA	Oral uptake rate	3.0	—	3.0	—	3.0	—

<sup>a</sup>For the purpose of this comparison, it was necessary to add oral uptake to the model of Reitz et al. (1996), which includes only inhalation exposure. This was accomplished by adding a zero-order input term in the equation for the liver, in the same fashion as in the model of Clewell et al. (1996b).

<sup>b</sup>The parameter values for the Reitz et al. (1996) model are taken from Table 1 of that publication with the exception of the blood/air partition coefficient in the mouse, which was incorrectly reported as 2.26. The value shown in Table A-1 is the value actually used in the risk calculations (R.H. Reitz, personal communication).

<sup>c</sup>See Table A-2.

<sup>d</sup>The scaling factor for maximum velocity of metabolism is 0.70.

<sup>e</sup>Different from reported value of 2.41 (Reitz et al., 1996), but used in risk calculations (D. Reitz, personal communication).

<sup>f</sup>The parameters listed here are the tissue/blood partition coefficients. They were derived from the tissue/air partition coefficients in Table 1 of Reitz et al. (1996) by dividing by the blood/air partition coefficient.

<sup>g</sup>Not used in model.

**Table A-2. Species/sex/study-dependent parameter values in Clewell model**

		BW	VFC	VMAX1C	VMAX2C
Swiss albino mice (inhalation study)	Male	0.044	0.13	8.0	0.1 <sup>a</sup>
	Female	0.040	0.12	5.0	3.0
Sprague-Dawley rats (inhalation study)	Male - low dose	0.638	0.19	4.0	2.0
	Male - high dose	0.433	0.13	4.0	2.0
	Female - low dose	0.485	0.20	3.0	0.1 <sup>b</sup>
	Female - high dose	0.321	0.14	3.0	0.1 <sup>b</sup>
Sprague-Dawley rats (gavage study)	Male - low dose	0.632	0.19	4.0	2.0
	Male - high dose	0.405	0.12	4.0	2.0
	Female - low dose	0.445	0.18	3.0	0.1 <sup>b</sup>
	Female - high dose	0.301	0.13	3.0	0.1 <sup>b</sup>
Wistar rats (drinking water study)	Male	0.436	0.14	4.0	2.0
	Female	0.245	0.11	3.0	0.1 <sup>b</sup>

<sup>a</sup>Zero was used as the variance for this value of VMAX2C in the PBPK-Sim runs.

<sup>b</sup>For the purpose of this comparison, it was necessary to add oral uptake to the model of Reitz et al. (1996), which includes only inhalation exposure. This was accomplished by adding a zero-order input term in the equation for the liver, in the same fashion as in the model of Clewell et al. (1996b).

The impact of differences in the model parameters can better be evaluated in light of the results of the parameter sensitivity analysis conducted on the Clewell et al. (1995a) model. Of the parameters discussed above for which the two models differ, only the body weight, liver volume, and metabolism parameters have significant impact on dose metric calculations. Alveolar ventilation and the blood/air partition coefficient have only a minor impact, whereas the fat volume and tissue/blood partition coefficients have essentially no impact at all. With respect to the more important differences between the two models in the body weights, liver volumes, and metabolism parameters, the Clewell et al. model used the actual reported body weights, adopted the most recently recommended liver volumes (ILSI, 1994), and employed a much larger number of studies to estimate and validate the metabolic parameters.

The best way to compare the impact of model selection on risk estimates is simply to employ the two models in estimating risks from the same studies. The results of this exercise are shown in Tables A-3 through A-5. Table A-3 shows the dose metrics calculated with the two models.<sup>3</sup> The dose metrics in every case are very similar. The greatest difference, of about 50% for the Feron et al. (1981) dietary study, is due to the different values used in the models for the volume of the liver in the rat. As mentioned above, the liver volume used in the Clewell et al. (1995a) model is the value recommended by ILSI (1994). Table A-4 compares the cancer ED<sub>10s</sub> for angiosarcoma calculated with the dose metric from the two models, and Table A-5 provides the same comparison for noncancer BMD<sub>10s</sub> for liver necrosis. It should be noted that although the NOAEL for liver necrosis is 10-fold higher than for liver cell polymorphism, the endpoint used for development of the RfC and RfD in the present assessment, the model comparison is still valid. The high level of agreement between the ED<sub>10s</sub> and BMD<sub>10s</sub> based on the two different models demonstrates the reliability of PBPK models that have been properly designed and validated against experimental data.

---

<sup>3</sup>The dose metrics for the Reitz et al. (1996) model were obtained with an ACSL version of the model (VCDOSE2.CSL) kindly provided by Dr. Reitz. The only modification of the model for use in this study was to add a zero-order oral input term. The model was run with the parameter values shown in Table A-1 and the dose metric calculations were compared with Tables 4 and 5 in Reitz et al. (1996). The ACSL model reproduced the reported mouse dose metrics within 2% and reproduced the human dose metrics exactly. The minor differences in the mouse dose metrics are probably due to rounding off of the parameter values as reported in Table 1 of Reitz et al. (1996) from those originally used to obtain Tables 4 and 5 of that paper (R.H. Reitz, personal communication).



**Table A-3. Comparison of values for lifetime average delivered dose**

Reference	Route	Species	Duration	Dose	Incidence		Clewell et al.		Reitz et al.
					Male	Female	Male	Female	
Occupational exposure	Inhalation	Human	Continuous	1 ppm			1.75		2.05
	Drinking water			0.028 mg/kg/day			0.58		0.86
Maltoni et al. (1988) (BT4) <sup>a</sup>	Inhalation	Swiss albino mice	4 hr/d, 5 d/wk for 30 of 104 wks	0 ppm	0/80	0/70			
				50 ppm	1/30	0/30	33.36	32.33	38.91
				250 ppm	9/30	9/30	159.81	138.67	175.36
				500 ppm	6/30	8/30	256.57	182.81	269.50
				2500 ppm	6/29	10/30	295.63	246.77	337.01
				6000 ppm	2/30	11/30	304.79	276.34	348.82
				10,000 ppm	1/26	9/30	310.22	289.56	354.47
Maltoni et al. (1981, 1984) (BT1, BT2, and BT15) <sup>b</sup>	Inhalation	Sprague-Dawley rats	4 hr/d, 5 d/wk for 52 of 147 wks (BT15)	0 ppm	0/108	0/141			
				1 ppm	0/48	0/55	0.61	0.59	0.74
				5 ppm	0/43	0/47	3.03	2.96	3.69
				10 ppm	0/42	1/46	6.05	5.90	7.36
			52 of 135 wks	25 ppm	1/41	4/40	15.05	14.61	18.37
				50 ppm	0/26	1/29	32.46	31.27	39.76
			52 of 143 wks (BT2)	100 ppm	0/37	1/43	59.70	55.95	73.81
				150 ppm	1/36	5/46	85.90	76.67	107.36
				200 ppm	7/42	5/44	107.39	90.00	135.09
			52 of 135 wks (BT1)	250 ppm	1/28	2/26	130.25	103.45	162.58
				500 ppm	0/22	6/28	163.41	116.94	188.89
				2500 ppm	6/26	7/24	220.99	134.37	222.82
				6000 ppm	3/17	10/25	250.71	143.72	245.18
Feron et al. (1981)	Drinking water	Wistar rats	135 weeks (males) 144 weeks (females)	0 mg/kg/day	0/55	0/57			
				1.7 mg/kg/day	0/58	0/58	39.54	38.61	63.67
				5.0 mg/kg/day	6/56	2/59	116.10	113.24	187.03
				14.1 mg/kg/day	27/59	9/57	325.85	316.63	525.26

<sup>a</sup>The denominator for the incidence data is the total number of mice, as used by Chen and Blancato (1989).

<sup>b</sup>The denominator is the number of rats alive when the first angiosarcoma was observed, as used by Chen and Blancato (1989). However, the male and female incidence data shown here differ from that reported by Chen and Blancato (1989), after verification with the original study (Maltoni et al., 1984).

**Table A-4. Comparison of ED<sub>10</sub>s based on angiosarcoma incidence**

Study	Sex	Clewell et al. (1995a)		Reitz et al. (1996)	
		ED <sub>10</sub> (mg metabolite/kg/day)		ED <sub>10</sub> (mg metabolite/kg/day)	
		95% lower bound	MLE	95% lower bound	MLE
Rats, inhalation Maltoni et al. (1981, 1984) (BT1, BT2, and BT15)	M	112.24	157.14	133.53	180.05
	F	53.19	74.35	76.35	105.97
Mice, inhalation Maltoni et al. (1981, 1984) (BT4)	M	112.07	153.16	125.59	171.62
	F	51.94	65.52	67.88	85.63
Average inhalation		82.36	112.54	100.84	135.82
Rats, dietary Feron et al. (1981) <sup>a</sup>	M	94.93	132.32	152.89	213.28
	F	182.02	241.33	307.14	400.11
Average oral		138.48	186.82	227.01	306.69

<sup>a</sup>All risks from the Feron study shown here were calculated using a quantal model, multistage option. The risks presented in Appendix B were calculated using a time-to-tumor model, to account for increased deaths in the mid- and high-dose groups.

**Table A-5. Comparison of BMD10 values (in units of dose metric) based on liver necrosis**

Study	Sex	Clewell et al. (1995a)		Reitz et al. (1996)	
		BMD <sub>10</sub> <sup>a</sup>	MLE <sup>b</sup>	BMD <sub>10</sub>	MLE <sup>c</sup>
Feron et al. (1981)	M	70.04	139.25	112.90	224.48
	F	40.41	54.75	66.93	90.68
Average		55.22	97.00	89.92	157.58

<sup>a</sup>BMD<sub>10</sub> is the benchmark dose at 10% extra risk based on dichotomous data.

<sup>b</sup>MLE=maximum likelihood estimate.

<sup>c</sup>The parameter values for the Reitz et al. (1996) model are taken from Table 1 of that publication with the exception of the blood/air partition coefficient in the mouse, which was incorrectly reported as 2.26. The value shown in Table A-1 is the value actually used in the risk calculations (R.H. Reitz, personal communication).

## REFERENCES

Baretta, ED; Stewart, RD; Mutchler, JE. (1969) Monitoring exposures to vinyl chloride vapor: breath analysis and continuous air sampling. *Am Indust Hygiene Assoc J* 30:537-544.

Chen, CW; Blancato, JN. (1989) Incorporation of biological information in cancer risk assessment: example - vinyl chloride. *Cell Biol Toxicol* 5:417-444.

Clement International. (1990) Development and validation of methods for applying pharmacokinetic data in risk assessment. Final report. Volume V: vinyl chloride. AAMRL-TR-90-072. Prepared for the Department of the Air Force, Armstrong Aerospace Medical Research Laboratory, Wright-Patterson Air Force Base, Ohio.

Clewell, HJ; Gentry, PR; Gearhart, JM; Allen, BC; Andersen, ME. (1995a) The development and validation of a physiologically based pharmacokinetic model for vinyl chloride and its application in a carcinogenic risk assessment for vinyl chloride. ICF Kaiser report prepared for EPA/OHEA and OSHA/DHSP.

Clewell, HJ; Covington, TR; Crump, KS; Haber, LT; Andersen, ME. (1995b) The application of a physiologically based pharmacokinetic model for vinyl chloride in a noncancer risk assessment. ICF/Clement report prepared for EPA/NCAA under contract number 68-D2-0129.

Feron, HJ; Hendriksen, CFM; Seek, HJ; Til, HP; Spit, BJ. (1981) Linesman oral toxicity study of vinyl chloride in rats. *Food Cosmet Toxicol* 19:317-333.

Filser, JE; Bolt, HM. (1979) Pharmacokinetics of halogenated ethylene in rats. *Arch Toxicol* 42:123-136.

Fox, A; Collier, P. (1977) Mortality experience of workers exposed to vinyl chloride monomer in the manufacture of polyvinyl chloride in Great Britain. *Br J Ind Med* 344:1-10.

Gargas, ML; Clewell, HJ, III; Andersen, ME. (1990) Gas uptake techniques and the rates of metabolism of chloromethanes, chloroethanes, and chloroethylenes in the rat. *Inhal Toxicol* 2:295-319.

Gehring, PJ; Watanabe, PG; Park, CN. (1978) Resolution of dose-response toxicity data for chemicals requiring metabolic activation: example—vinyl chloride. *Toxicol Appl Pharmacol* 44:581-591.

International Life Sciences Institute (ILSI) Risk Science Institute. (1994) Physiological parameter values for PBPK models. Report prepared for the USEPA Office of Health and Environmental Assessment.

Maltoni, C; Lefemine, G; Ciliberti, A; Cotti, G; Carretti, D. (1981) Carcinogenicity bioassay of vinyl chloride monomer: a model of risk assessment on an experimental basis. *Environ Health Perspect* 41:3-29.

Maltoni, C; Lefemine, G; Ciliberti, A; Cotti, G; Carretti, D. (1984) Experimental research on vinyl chloride carcinogenesis. Archives of Research on Industrial Carcinogenesis. Vol. 2. Maltoni, C; Mehlman, MA, editors. Princeton, NJ: Princeton Scientific Publishers.

Ramsey, JR; Andersen, ME. (1984) A physiologically based description of the inhalation pharmacokinetics of styrene in rats and humans. Toxicol Appl Pharmacol 73:159-175.

Reitz, RH; Gargas, ML; Anderson, ME; Provan, WF; Green, T. (1996) Predicting cancer risk from vinyl chloride exposure with a physiologically based pharmacokinetic model. Toxicol Appl Pharmacol 137:253-267.

Watanabe, PG; McGowan, GR; Madrid, EO; Gehring, PJ. (1976) Fate of 14C-vinyl chloride following inhalation exposure in rats. Toxicol Appl Pharmacol 37:49-59.

## **APPENDIX B. THE DEVELOPMENT AND VALIDATION OF A PBPK MODEL FOR VINYL CHLORIDE (VC) AND ITS APPLICATION IN A CARCINOGENIC RISK ASSESSMENT**

This appendix documents the development of the model used to estimate VC cancer risk, as well as the results of the modeling. The risk estimates presented in this appendix were calculated using the 1-stage version of the LMS model, so the specific risk estimates are slightly different **from** those calculated using the LMS or ED<sub>10</sub>/linear models. Currently recommended risk values using the LMS and ED<sub>10</sub>/linear models are presented in the main document. Other PBPK models developed for VC, and a comparison between the Clewell model and another recent model (Reitz et al., 1996), are discussed in Appendix A.

The liver tumor data utilized for model development and presented in this section include only angiosarcomas, in order to better compare results with other assessments using angiosarcoma data both for rodents and across species. Cancer risk estimates were subsequently revised to include all liver tumors. These revised estimates are the ones listed in the Toxicological Review and the cancer summary. Table B-1 summarizes the incidence of angiosarcomas (in some cases only total angiosarcomas) reported in those chronic animal bioassays in which a statistically significant increase was observed. For completeness, however, two other tumor types observed at low concentrations in the rodent were also analyzed: nephroblastoma and mammary gland adenocarcinoma. Table B-2 summarizes the incidence of these tumors reported in chronic animal bioassays.

### **B.1. MECHANISM OF CARCINOGENICITY OF VC**

As discussed in the main document, VC carcinogenicity is due to a reactive metabolite, probably CEO. The reactive metabolite forms DNA adducts, and a persistent DNA adduct is believed to lead to tumorigenesis.

The majority of the DNA adduct studies conducted with VC have been conducted on or related to the hepatocyte. However, although VC is primarily metabolized in the hepatocyte (Ottewalder and Bolt, 1980), the primary target cell for liver carcinogenicity is the sinusoidal cell, as indicated by the incidence of liver angiosarcoma in both animals and humans. Sinusoidal cells show a relatively low activity for transforming VC into reactive, alkylating metabolites, roughly 12% of the activity of hepatocytes (Ottewalder and Bolt, 1980). Therefore, it has been suggested that the carcinogenic metabolites of VC may have to migrate from the hepatocytes to produce tumors in the sinusoidal cells (Laib and Bolt, 1980). This possibility was suggested by Laib and Bolt (1980) following their observation that alkylating metabolites of VC were capable of diffusing through an artificial semipermeable membrane in a model in vitro system. In studies conducted in vitro with rat hepatocytes by Guengerich et al. (1981), more than 90% of the hexane-insoluble metabolites were found to migrate out of the cell, with more than 70% of the total irreversibly bound species found outside the cell. These results were interpreted to indicate that the majority of the reactive metabolites can leave the intact hepatocyte. On the other hand,

**Table B-1. Summary of the angiosarcoma incidence data from vinyl chloride chronic animal bioassays**

Reference	Route	Strain/species	Concentration/ dose	Incidence	Exposure duration
Lee et al., 1977, 1978	Inhalation	Albino CD-1 mice (M,F)	0, 50, 250, 1,000 ppm	Males - 0/26, 3/29, 7/29 <sup>a</sup> , 13/33 <sup>a</sup> Females - 0/36, 0/34, 16/34 <sup>*</sup> , 18/36 <sup>*</sup>	6 hours/day, 5 days/week, 12 months
		CD rats (M,F)	0, 250, 1,000 ppm	Males - 0/35, 0/36, 2/36, 6/34 <sup>*</sup> Females - 0/35, 0/36, 10/34 <sup>*</sup> , 15/36 <sup>*</sup>	6 hours/day, 5 days/week, 12 months
Feron et al., 1979a,b, Feron and Kroes, 1979	Inhalation	Wistar rats (M,F)	0, 5,000 ppm	Males - 0/62, 6/62 <sup>*</sup> Females - 0/62, 16/62 <sup>*</sup>	7 hours/day, 5 days/week, 12 months
Hong et al., 1981	Inhalation	Albino CD-1 mice (M,F)	0, 50, 250, 1,000 ppm	Males - 0/60, 1/40, 8/44 <sup>*</sup> , 6/38 <sup>*</sup> Females - 1/60, 1/40, 5/40 <sup>*</sup> , 12/38 <sup>*</sup>	6 hours/day, 5 days/week, and sacrificed at 1, 3, or 6 months
		CD rats (M,F)	0, 50, 250, 1,000 ppm	Males - 0/36, 0/30, 1/36, 5/36 <sup>*</sup> Females - 0/36, 0/36, 4/32 <sup>*</sup> , 9/36 <sup>a,b</sup>	6 hours/day, 5 days/week, and sacrificed at 1, 3, 6 or 10 months
Drew et al., 1983	Inhalation	Fischer 344 rats (F)	0, 100 ppm	1/112 (control), 4/76 (0-6) <sup>*</sup> , 11/55 (0-12) <sup>*</sup> , 13/55 (0-18) <sup>*</sup> , 19/55 (0-24), 2/52 (6-12), 0/51 (12-18), 0/53 (18-24), 5/54 (6- 18) <sup>*</sup> , 2/49 (12-24)	6 hours/day, 5 days/week, 6, 12, 18, or 24 months, or held for 6 or 12 months and then exposed for 6 or 12 months
		Golden Syrian hamsters (F)	0, 200 ppm	0/143 (control), 13/88 (0-6) <sup>*</sup> , 4/52 (0-12) <sup>*</sup> , 2/103 (0-18), 3/53 (6-12), 0/50 (12-18), 0/52 (18- 24), 1/44 (6-18), 0/43 (12-24) <sup>b</sup>	6 hours/day, 5 days/week, 6, 12, 18, or 24 months, or held for 6 or 12 months and then exposed for 6 or 12 months
		B6C3F1 mice (F)	50 ppm	4/69 (control), 46/67 (0-6) <sup>*</sup> , 69/90 (0-12) <sup>*</sup> , 27/42 (6-12) <sup>*</sup> , 30/51 (12-18) <sup>*</sup> , 30/48 (6-18) <sup>*</sup> , 29/48 (12-24) <sup>c</sup>	6 hours/day, 5 days/week, 6, 12, 18, or 24 months, or held for 6 or 12 months and then exposed for 6 or 12 months
		CD-1 mice (F)	0, 50 ppm	1/71 (control), 29/67 (0-6) <sup>*</sup> , 30/47 (0-12) <sup>*</sup> , 20/45 (0-18) <sup>*</sup> , 11/49 (6-12) <sup>*</sup> , 5/53 (12-18), 17/46 (6-18) <sup>*</sup> , 3/50 (12-24) <sup>c</sup>	6 hours/day, 5 days/week, 6, 12, 18, or 24 months, or held for 6 or 12 months and then exposed for 6 or 12 months

**Table B-1. Summary of the angiosarcoma incidence data from vinyl chloride chronic animal bioassays (continued)**

Reference	Route	Strain/species	Concentration/ dose	Incidence	Exposure duration
Keplinger et al., 1975 (8 month interim) MCA, 1980 (in U.S. EPA, 1985)	Inhalation	COBS Charles River rats (M,F)	0, 50, 200, 2,500 ppm	0/143, 28/139*, 82/141*, 114/147*	7 hours/day, 5 days/week for 12 months
		CDI Swiss Charles River mice (M,F)	0, 50, 200, 2,500 ppm	0/97, 46/121*, 130/134*, 101/101*	7 hours/day, 5 days/week for 9 months
		Syrian Golden hamsters (M,F)	0, 50, 200, 2,500 ppm	0/83, 7/74*, 12/88*, 56/66*	7 hours/day, 5 days/week for 12 months
Bi et al., 1985	Inhalation	Wistar rats (M)	0, 10, 100, 3,000 ppm	0/19, 0/20, 7/19*, 17/20*	6 hours/day, 6 days/week for 18 months
Maltoni et al., 1981, 1984 (BT1)	Inhalation	Sprague-Dawley rats (M,F)	0, 50, 250, 500, 2,500, 6,000, 10,000 ppm	0/58, 1/60, 3/59, 6/60, 13/60, 13/59*, 7/60 <sup>d</sup>	4 hours/day, 5 days/week for 52 weeks (135 weeks)
Maltoni et al., 1981, 1984 (BT2)	Inhalation	Sprague-Dawley rats (M,F)	0, 100, 150, 200 ppm	0/185, 1/120, 6/119, 12/120* <sup>d</sup>	4 hours/day, 5 days/week for 52 weeks (143 weeks)
Maltoni et al., 1981, 1984 (BT9)	Inhalation	Sprague-Dawley rats (M,F)	0, 50 ppm	0/98, 14/294*	4 hours/day, 5 days/week for 52 weeks (142 weeks)
Maltoni et al., 1981, 1984 (BT15)	Inhalation	Sprague-Dawley rats (M,F)	0, 1, 5, 10, 25 ppm	0/120, 0/118, 0/119, 1/119, 5/120* <sup>d</sup>	4 hours/day, 5 days/week for 52 weeks (147 weeks)
Maltoni et al., 1981, 1984 (BT10)	Inhalation	Sprague-Dawley rats (M,F)	0 (Group VII), 6,000 (Groups II, IV, VI), 10,000 (Groups I, III, V) ppm	1/118 (Group I), 0/120 (Group II), 1/119 (Group III), 3/118* (Group IV), 1/119 (Group V), 1/120 (Group VI), 0/227 (Group VII)	Groups I and II - 4 hours/day, 5 days/week, 5 weeks Groups III and IV - 1 hour/day, 4 days/week for 25 weeks Groups V and VI - 4 hours/day, 1 day/week for 25 weeks (154 weeks)
Maltoni et al., 1981, 1984 (BT7)	Inhalation	Wistar rats (M)	0, 50, 250, 500, 2,500, 6,000, 10,000 ppm	0/38, 0/28, 1/27, 3/28, 3/25, 3/26, 8/27*	4 hours/day, 5 days/week, for 52 weeks (165 weeks)
Maltoni et al., 1981, 1984 (BT4)	Inhalation	Swiss mice (M,F)	0, 50, 250, 500, 2,500, 6,000, 10,000 ppm	0/150, 1/60, 18/60*, 14/60*, 16/59*, 13/60*, 10/56*	4 hours/day, 5 days/week for 30 weeks (81 weeks)

5/17/99

B-3

DRAFT-DO NOT CITE OR QUOTE



**Table B-1. Summary of the angiosarcoma incidence data from vinyl chloride chronic animal bioassays (continued)**

Reference	Route	Strain/species	Concentration/ dose	Incidence	Exposure duration
Maltoni et al., 1988 (BT4001, 4006)	Inhalation	Sprague-Dawley rats (Breeders - F; Embryos - M,F)	0, 2500 ppm	Breeders - 0/60, 27/54 Embryos (M) - 0/158 (control), 24/60* (Group I), 36/64* (Group II) Embryos (F) - 0/149 (control), 28/60* (Group I), 46/63* (Group II)	Breeders - 4 hours/day, 5 days/week for 7 weeks and then 7 hours/day, 5 days/week for 69 weeks Embryos - 4 hours/day, 5 days/week for 7 weeks and then 7 hours/day 5 days/week for 8 (Group I) or 69 weeks (Group II)
Groth et al., 1981	Inhalation	Sprague-Dawley rats (M,F) (ages 6, 18, 32, and 52 weeks)	0, 940 ppm	6 weeks - males - 0/110, 1/83, females - 0/110, 2/88 18 weeks - males - 0/119, 2/91, females - 0/120, 7/97* 32 weeks - males - 1/115, 7/94*, females - 0/120, 27/98* 52 weeks - males - 0/128, 18/102*, females - 0/127, 14/104*	7 hours/day, 5 days/week for 24 weeks
Radike et al., 1981	Inhalation	Sprague-Dawley rats (M)	0, 600 ppm	0/80, 18/80*	4 hours/day, 5 days/week for 52 weeks
Feron et al., 1981	Oral - diet	Wistar rats (M,F)	0, 1.7, 5.0, 14.1 mg/kg/day	Males - 0/55, 0/58, 6/56*, 27/59* Females - 0/57, 0/58, 2/59, 9/57*	4 hours/day for 135 or 144 weeks
Maltoni et al., 1981, 1984 (BT11)	Gavage	Sprague-Dawley rats (M,F)	0, 2.38, 11.9, 35.7 mg/kg/day	0/80, 0/80, 10/80*, 17/80*	4 to 5 days/week for 52 weeks (136 weeks)

\*Significantly different from control at p = 0.05.

<sup>b</sup>Incidence for both males and females includes only those animals sacrificed at 6 and 10 months. The incidence data for those animals sacrificed at 1 and 3 months was not reported.

<sup>c</sup>Incidence reported for hemangiosarcomas at all sites only. The authors reported that these tumors occurred primarily in the skin, spleen, and liver.

<sup>d</sup>Hemangiosarcomas for all sites reported.

<sup>e</sup>The denominator shown is the total number of animals examined. However, the denominator used for risk calculations was the number alive when the first angiosarcoma was observed, as shown in Table C-5.

<sup>f</sup>Reported total angiosarcomas.

5/17/99

B-4

DRAFT-DO NOT CITE OR QUOTE

**Table B-2. Summary of incidence data on other low-dose tumors from vinyl chloride chronic animal bioassays**

Reference	Route	Species	Endpoint	Dose	Incidence <sup>a</sup>	Exposure duration
Lee et al., 1977, 1978	Inhalation	Albino CD-1 mice (F)	Mammary gland tumors	0, 50, 250, 1,000 ppm	0/36, 9/34, 3/34, 13/36	6 hr/d, 5 d/wk, 12 mo
Drew et al., 1983(a)	Inhalation	Fischer-344 rats (F)	Mammary gland: fibroadenoma and adenocarcinoma	0, 100 ppm	Fibroadenoma: 24/112, 26/55 (0-24) Adenocarcinoma: 5/112, 5/55 (0-24)	6 hr/d, 5 d/wk, 6, 12, 18 or 24 mo, or held for 6 or 12 mo and then exposed for 6 or 12 mo
		Fischer-344 rats (F)	Hepatocellular carcinoma	0, 100 ppm	Females: 1/112, 9/55 (0-24)	
		Golden Syrian hamsters (F)	Mammary gland carcinoma	0, 200 ppm	Females: 0/143, 47/102 (0-18)	
		B6C3F1 mice (F)	Mammary gland carcinoma	0, 50 ppm	Females: 3/69, 37/90 (0-12)	
		CD-1 Swiss mice (F)	Mammary gland carcinoma	0, 50 ppm	Females: 2/71, 22/45 (0-18)	
Radike et al., 1981	Inhalation	Sprague-Dawley rats (M)	Hepatocellular carcinoma	0, 600 ppm	Males: 1/80, 35/80 (0-11.5)	4 hr/d, 5 d/wk, 52 wks
Maltoni et al., 1981, 1984 (BT1)	Inhalation	Sprague-Dawley rats (M,F)	Nephroblastoma	0, 50, 250, 500, 2500, 6,000, 10,000 ppm	M & F: 0/58, 1/60, 5/59, 6/60, 6/60, 5/59, 5/60	4 hr/d, 5 d/wk for 52 wk (held 135 wk)
			Mammary malignant tumor	0, 50, 250, 500, 2500, 6,000, 10,000 ppm	M & F: 0/58, 2/60, 2/59, 1/60, 2/60, 0/59, 3/60	

**Table B-2. Summary of incidence data on other low-dose tumors from vinyl chloride chronic animal bioassays (continued)**

Reference	Route	Species	Endpoint	Dose	Incidence <sup>a</sup>	Exposure duration
Maltoni et al., 1981, 1984 (BT2)	Inhalation	Sprague-Dawley rats (M,F)	Nephroblastoma	0, 100, 150, 200 ppm	120	4 hr/d, 5 d/wk for 52 wk (held 143 wk)
			Mammary malignant tumor	0, 100, 150, 200 ppm	M & F: 2/128, 4/120, 6/119, 6/120	
Maltoni et al., 1981, 1984 (BT4)	Inhalation	Swiss mice (M,F)	Mammary carcinoma	0, 50, 250, 500, 2,500, 6,000, 10,000 ppm	1/150, 12/60, 12/60, 8/60, 8/59, 8/60, 13/56	4 hr/d, 5 d/wk for 30 wk (held 81 wk)
Maltoni et al., 1981, 1984 (BT3)	Inhalation	Sprague-Dawley rats (M,F)	Nephroblastoma	0, 50, 250, 500, 2,500, 6,000, 10,000 ppm	M&F: 0/190, 3/58, 6/59, 0/60, 2/60, 1/60, 1/58	4 hr/d, 5 d/wk, 17 wk
			Mammary malignant tumor	0, 50, 250, 500, 2,500, 6,000, 10,000 ppm	M&F: 5/190, 1/58, 1/59, 3/60, 4/60, 1/60, 1/58	
Maltoni et al., 1981, 1984 (BT9)	Inhalation	Sprague-Dawley rats (M,F)	Nephroblastoma	0, 50 ppm	M&F: 0/98, 1/294	4 hr/d, 5 d/wk for 52 wk (held 142 wk)
			Mammary malignant tumor	0, 50 ppm	M&F: 10/98, 62/294	
Maltoni et al., 1981, 1984 (BT15)	Inhalation	Sprague-Dawley rats (M,F)	Nephroblastoma	0, 1, 5, 10, 25 ppm	M&F: 0/120, 0/118, 0/119, 0/119, 1/120	4 hr/d, 5 d/wk for 52 wk (held 147 wk)
			Mammary malignant tumor	0, 1, 5, 10, 25 ppm	M&F: 7/120, 15/118, 22/119, 21/119, 17/120	

5/17/99

B-6

DRAFT-DO NOT CITE OR QUOTE

**Table B-2. Summary of incidence data on other low-dose tumors from vinyl chloride chronic animal bioassays (continued)**

Reference	Route	Species	Endpoint	Dose	Incidence <sup>a</sup>	Exposure duration
Maltoni et al., 1981, 1984 (BT10)	Inhalation	Sprague-Dawley rats (M,F)	Nephroblastoma	Gp VII: control; Gps I, III, V: 10,000 ppm; Gps II, IV, VI: 6000 ppm	Gp VII: 0/227; Gps I, III, V: 0/118, 0/119, 0/119; Gps II, IV, VI: 1/120, 0/118, 1/120	Gps I & II: 4 hr/d, 5 d/wk, 5 wks; Gps III & IV: 1 hr/d, 4 d/wk, 25 wks; Gps V & VI: 4 hr/d, 1 d/wk, 25 wks (held 154 wks)
			Mammary malignant tumor	Gp VII: control; Gps I, III, V: 10000 ppm; Gps II, IV, VI: 6000 ppm	Gp VII: 17/227; Gps I, III, V: 13/118, 16/119, 20/119; Gps II, IV, VI: 13/120, 11/118, 12/120	
Feron et al., 1981	Oral – diet	Wistar rats (M,F)	Hepatocellular carcinoma	0, 1.7, 5.0, 14.1 mg/kg body weight/day	Males: 0/55, 1/58, 2/56, 8/59 Females: 0/57, 4/58, 19/59, 29/57	135 or 144 wks
			Neoplastic nodules	0, 1.7, 5.0, 14.1 mg/kg body weight/day	Males: 0/55, 1/58, 7/56, 23/59 Females: 2/57, 26/58, 39/59, 44/57	
			Combined incidence of angiosarcomas, hepatocellular carcinoma, and neoplastic nodules	0, 1.7, 5.0, 14.1 mg/kg body weight/day	Males: 0/55, 2/58, 11/56, 41/59 Females: 2/57, 28/58, 49/59, 56/57	
Til et al., 1983	Oral – diet	Wistar rats (M,F)	Hepatocellular carcinoma	0, 0.017, 0.17, 1.7 mg/kg body weight/day	Males: 0/99, 0/99, 0/99, 3/49 Females: 1/98, 0/100, 1/96, 3/49	149 wks

5/17/99

B-7

DRAFT-DO NOT CITE OR QUOTE

**Table B-2. Summary of incidence data on other low-dose tumors from vinyl chloride chronic animal bioassays (continued)**

Reference	Route	Species	Endpoint	Dose	Incidence <sup>a</sup>	Exposure duration
			Neoplastic nodules	0, 0.017, 0.17, 1.7 mg/kg body weight/day	Males: 0/99, 0/99, 0/99, 3/49 Females: 0/98, 1/100, 1/96, 10/49	
			Combined incidence of angiosarcomas, hepatocellular carcinoma, and neoplastic nodules	0, 0.017, 0.17, 1.7 mg/kg body weight/day	Males: 0/99, 0/99, 0/99, 5/49 Females: 1/98, 1/100, 1/96, 11/49	
			Mammary gland tumors	0, 0.017, 0.17, 1.7 mg/kg body weight/day	Males: 5/99, 8/99, 3/99, 0/49 Females: 41/98, 21/100, 28/96, 21/48	

<sup>a</sup>Tumor incidence provided for longest duration of exposure only.

5/17/99

B-8

DRAFT-DO NOT CITE OR QUOTE

sinusoidal cells do possess the ability to produce reactive metabolites from VC, albeit at a slower rate than the hepatocyte (Ottenwalder and Bolt, 1980). In either case, the greater susceptibility of the sinusoidal cells to the carcinogenic effects of VC may result from an inability of the sinusoidal cells to repair one or more of the DNA adducts produced by VC as efficiently as the hepatocytes. Furthermore, the same dose metric (e.g., total amount of VC metabolism divided by the volume of the liver) is applicable whether the carcinogenic metabolites are produced in the hepatocyte or the sinusoidal cell.

## **B.2. SELECTION OF RISK ASSESSMENT APPROACH**

Based on the information above on the pharmacokinetics, metabolism, and mechanism of carcinogenicity of VC, it is necessary to determine the appropriate approach for conducting a human risk assessment. Clearly, the evidence is strong that the carcinogenicity of VC is related to the production of reactive metabolic intermediates. The most appropriate pharmacokinetic dose metric for a reactive metabolite is the total amount of the metabolite generated divided by the volume of the tissue into which it is produced (Andersen et al., 1987a). In the case of VC, reasonable dose metrics for angiosarcoma would include the total amount of metabolism divided by the volume of the liver (RISK), or the total amount of metabolism not detoxified by reaction with glutathione, again divided by the volume of the liver (RISKM). A third, less likely possibility, that the GSH conjugate of VC is subsequently metabolized to a reactive species that is responsible for the carcinogenicity, can also be considered by using a dose metric based on the total amount of reaction with GSH divided by the volume of the liver (RISKG). The assumption underlying the use of these dose metrics is that the concentration of the actual carcinogenic moiety, or the extent of the crucial event associated with the cellular transformation, is linearly related to this pseudoconcentration of reactive intermediates, and that the relationship of the actual carcinogenic moiety or crucial event to the dose metric is constant across concentration and species. Specifically, the average amount generated in a single day is used, averaged over the lifetime (i.e., the lifetime average daily dose, or LADD). The use of a dose rate, such as the LADD, rather than total lifetime dose, has been found empirically to provide a better cross-species extrapolation of chemical carcinogenic potency (U.S. EPA, 1992).

Subsequent steps in the carcinogenic mechanism related to specific adduct formation, detection, and repair, as well as to the consequences of DNA mistranscription/misreplication and the potential impact of increased cell proliferation, have been only sketchily outlined and have not yet reached the point where they could be incorporated into a risk assessment in any quantitative form. However, there appears to be sufficient evidence to justify the assumption that VC acts as a classic initiator, producing genetic transformations through direct reaction of its metabolites with DNA. Therefore, the traditional assumption of low-dose linearity of risk appears to be warranted, and the linearized multistage (LMS) model would seem to be the most appropriate for low-dose extrapolation.

### **B.3. DESCRIPTION OF PBPK MODEL FOR VC**

#### **B.3.1. General - Model Outputs (Dose Metrics) and Conversion to Human Values**

The PBPK model for VC developed in this study is shown in Figure A-1. As mentioned earlier, the model is basically an adaptation of a previously developed PBPK model for vinylidene chloride (D'Souza and Andersen, 1988). For a poorly soluble, volatile chemical like VC, only four tissue compartments are required: a richly perfused tissue compartment that includes all of the organs except the liver, a slowly perfused tissue compartment that includes all of the muscle and skin tissue, a fat compartment that includes all of the fatty tissues, and a liver compartment. All metabolism is assumed to occur in the liver, which is a good assumption in terms of the overall kinetics of VC, but the assumption would have to be revised to include target-tissue-specific metabolism if a serious attempt were to be made to perform a VC risk assessment for a tissue other than the liver (Andersen et al., 1987a). The model also assumes flow-limited kinetics, or venous equilibration; that is, that the transport of VC between blood and tissues is fast enough for steady state to be reached within the time it is transported through the tissues in the blood.

Metabolism of VC is modeled by two saturable pathways, one high affinity, low capacity (with parameters VMAX1C and KM1) and one low affinity, high capacity (with parameters VMAX2C and KM2). Subsequent metabolism is based on the metabolic scheme shown in Figure 1. The reactive metabolites (whether CEO, CAA, or other intermediates) may then either be metabolized further, leading to CO<sub>2</sub>; react with GSH; or react with other cellular materials, including DNA. Because exposure to VC has been shown to deplete circulating levels of GSH, a simple description of GSH kinetics was also included in the model.

The model is designed for input from inhalation (using inhaled concentration), gavage (using a first-order rate constant for uptake from corn oil), and drinking water/diet (using a zero-order rate constant for uptake), although the data available to support these routes (shown below) vary considerably. Various dose rate scenarios can be accommodated for inhalation (e.g., number of hours exposed/day and number of days/week) and for water/diet (e.g., mg/kg absorbed over a set number of hours). Continuous exposure scenarios can also be simulated. As discussed above, the most logical output from the model upon which to base this assessment is the total amount of VC metabolized in the liver divided by the volume of the liver, designated as "RISK" in the model. The other dose metrics mentioned above, RISKM and RISKG, were considered but were not used in this assessment. The direct output from the model is the daily average dose for either the RISK dose metric or for the total amount of VC metabolized/body weight (designated "AMET"). Lifetime average delivered doses (LADDs) were calculated by factoring the daily average dose both by the fraction of the week exposed (e.g., 5/7 days) and by the fraction of the lifespan the exposure period spanned (e.g., 52/147 weeks).

As discussed in the main document, the risk modeling was conducted using the animal target tissue dose, i.e. the dose metric RISK. The calculated risk values based on the animal dose metric were assumed to correspond to those from the same human dose metric. The human dose metric was then converted to a human dose as described in the main document. The following equations were then used to calculate the risk in the units of mg vinyl chloride ingested/kg body weight/day (oral) or µg vinyl chloride/m<sup>3</sup> (inhalation):

Administered Dose Slope factor (oral, LED10 method) =  $0.1 \div \text{Tissue dose LED10 (mg metabolite/kg tissue/day)} \times 0.581 [(mg\ metabolite/kg\ tissue/day)/(mg/L\ vinyl\ chloride\ in\ drinking\ water)] \div 2\ L\ water\ ingested/day \times 70\ kg$

where:

Tissue dose LED10 is the lower bound on the ED10, in units of (mg metabolite/kg tissue/day) and is derived from the TOXRISK output;

0.1 represents the 10% response that is divided by the calculated LED10 to get the slope at the LED10;

0.581 = Conversion factor for the dose of metabolites to the human liver from a sample human continuous oral exposure (1 mg/L in drinking water);

70 kg = Human default body weight;

2 L/d = Default for daily drinking water ingestion.

Using the linearized multistage model, the conversion is as follows:

Administered dose slope factor (LMS) =  $\text{Target tissue slope factor (mg metabolite/kg tissue/day)}^{-1} \times 0.58 [(mg\ metabolite/kg\ tissue/day)/(mg/L\ vinyl\ chloride\ in\ drinking\ water)] \div 2\ L\ water\ ingested/day \times 70\ kg$

where the constants in the conversion are as described above.

To calculate the inhalation unit risk using the LED10 method, the conversion is as follows:

Inhalation Unit Risk (LED10 method) =  $0.1 \div \text{Tissue dose LED10 (mg metabolite/kg tissue/day)} \times 1.74 [(mg\ metabolite/kg\ tissue/day)/(ppm\ vinyl\ chloride)] \times 0.039 (ppm/mg/m^3) \times 10^{-3} (\mu g/m^3)/(mg/m^3)$

where:

1.74 = Conversion factor for the dose of metabolites to the human liver from a sample human continuous inhalation exposure (1 ppm in air).

#### **B.4. PARAMETERIZATION AND VALIDATION**

The parameters for the model are listed in Tables B-3 and B-4. The physiological parameters are the current EPA reference values (U.S. EPA, 1988b), except for alveolar ventilation in the human, which was calculated from the standard EPA value for the ventilation rate in the human, 20 m<sup>3</sup>/day, assuming a 33% pulmonary dead space. The partition coefficients for Fisher-344 (F344) rats were taken from Gargus et al. (1989), and those for Sprague-Dawley



rats were taken from Barton et al. (1995). The Sprague-Dawley values were also used for modeling of Wistar rats. Blood/air partition coefficients for the other species were obtained from Gargas et al. (1989), and the corresponding tissue/blood partition coefficients were estimated by dividing the Sprague-Dawley rat tissue/air partition coefficients by the appropriate blood/air value.

The affinity for the 2E1 pathway (KM1) in the rat, mouse, and hamster was set to 0.1 on the basis of studies of the competitive interactions between CYP2E1 substrates in the rat (Barton et al., 1995; Andersen et al., 1987b). The affinity used for the non-2E1 pathway (KM2) in the mouse and rat was set during the iterative fitting of the rat total metabolism, glutathione depletion, and rate of metabolism data, described below. The capacity parameters for the two oxidative pathways (VMAX1C and VMAX2C) in the mouse, rat, and hamster were estimated by fitting the model to data from closed-chamber exposures with each of the species and strains of interest (Barton et al., 1995; Bolt et al., 1977; Clement, 1990; Gargas et al., 1990). After the other parameters were scaled from animal weights obtained from individual studies, the model was exercised for optimization to a single pair of values, VMAX1C and VMAX2C, to be used for all of the data on a given sex/strain/species.

Initial estimates for the subsequent metabolism of the reactive metabolites and for the glutathione submodel in the rat were taken from the model for vinylidene chloride (D'Souza and Andersen, 1988). These parameter estimates, along with the estimates for VMAX2C and KM2, were then refined for the case of VC in the Sprague-Dawley rat using an iterative fitting process that included the closed-chamber data for the Sprague-Dawley and Wistar rat (Barton et al., 1995; Bolt et al., 1977; Clement, 1990) along with data on glutathione depletion (Jedrichowski et al., 1985; Watanabe et al., 1976c), **and** total metabolism (Gehring et al., 1978). The parameters obtained for the rat were used for the other species with appropriate allometric scaling (e.g., body weight to the -1/4 for the first order rate constants).

Figures B-1a through B-1d show the results of this interactive fitting process for mice and Figures B-2a thru B-2h present the results for several strains of rats, with Figure B-2i demonstrating the fit to hamster data. Figures B-3a through B-3c demonstrate the capability of the model to simulate depletion of internal GSH (measured as cytoplasmic nonprotein sulfhydryl concentration) as a function of external air exposure to various concentrations of VC and as a function of time after inhalation exposure to VC (Jedrichowski et al., 1985). Figure B-4 shows data and simulation results from modeling total metabolism (the amount of radiolabeled VC remaining in rat carcasses after a 6-hr air exposure to VC) (Gehring et al., 1978). No systematic errors could be surmised from these

**Table B-3. Model parameters and dose metrics for the vinyl chloride model**

**Unscaled Parameters**

		Mouse (CV-%) <sup>a</sup>	Rat (CV-%)	Human (CV-%)
BW	Body weight (kg)	— <sup>b</sup> (11)	— (11)	70.0 (30)
QPC	Alveolar ventilation (L/hr, 1 kg animal)	30.0 (58)	21.0 (58)	24.0 (16)
QCC	Cardiac output (L/hr, 1 kg animal)	18.0 (9)	18.0 (9)	16.5 (9)
Tissue blood flows (fraction of cardiac output):				
QRC	Flow to rapidly perfused tissues	0.51 (50)	0.51 (50)	0.5 (20)
QFC	Flow to fat	0.09 (60)	0.09 (60)	0.05 (30)
QSC	Flow to slowly perfused tissues	0.15 (40)	0.15 (40)	0.19 (15)
QLC	Flow to liver	0.25 (96)	0.25 (96)	0.26 (35)
Tissue volumes (fraction of body weight):				
VSC	Volume of slowly perfused tissues	0.77 (30)	0.75 (30)	0.63 (30)
VFC	Volume of fat	— (30)	— (30)	0.19 (30)
VRC	Volume of richly perfused tissues	0.035 (30)	0.05 (30)	0.064 (10)
VLC	Volume of liver	0.055 (6)	0.04 (6)	0.026 (5)
Partition coefficients:				
PB	Blood/air	2.26 (15)	2.4 (15)	1.16 (10)
PF	Fat/blood	10.62 (30)	10.0 (30)	20.7 (30)
PS	Slowly perfused tissue/blood	0.42 (20)	0.4 (20)	0.83 (20)
PR	Richly perfused tissue/blood	0.74 (20)	0.7 (20)	1.45 (20)
PL	Liver/blood	0.74 (20)	0.7 (20)	1.45 (20)
Metabolic parameters:				
VMAX1 C	Maximum velocity of first saturable pathway (mg/hr, 1 kg animal)	— (20)	— (20)	4.0 (30)
KM1	Affinity of first saturable pathway (mg/L)	0.1 (30)	0.1 (30)	1.0 (50)
VMAX2 C	Maximum velocity of second saturable pathway (mg/hr, 1 kg animal)	— (20)	— (20)	0.1 (0)

**Table B-3. Model parameters and dose metrics for the vinyl chloride model (continued)**

		Mouse (CV-%) <sup>a</sup>	Rat (CV-%)	Human (CV-%)
KM2	Affinity of second saturable pathway (mg/L)	10.0 (30)	10.0 (30)	10.0 (50)
GSH parameters:				
KCO2C	First order CEO breakdown to CO <sub>2</sub>	1.6 (20)	1.6 (20)	1.6 (20)
KGSMC	Conjugated rate constant with metabolite	0.13 (20)	0.13 (20)	0.13 (20)
KFEEC	Conjugated rate constant with non-GSH	35.0 (20)	35.0 (20)	35.0 (20)
GSO	Initial GSH concentration	5,800.0 (20)	5,800.0 (20)	5,800.0 (20)
KBC	First order rate constant for GSH breakdown	0.12 (20)	0.12 (20)	0.12 (20)
KS	Constant controlling resynthesis	2,000.0 (20)	2,000.0 (20)	2,000.0 (20)
KOC	Zero order production of GSH	28.5 (20)	28.5 (20)	28.5 (20)
Dosing parameters:				
KA	Oral uptake rate (/hr)	3.0 (50)	3.0 (50)	3.0 (50)

<sup>a</sup>CV-%: Coefficient of variation = 100 \* Standard deviation/mean

<sup>b</sup>See Table B-4.

**Table B-4. Strain/study-specific parameter values**

		BW	VFC	VMAX1C	VMAX2C
Swiss albino mice (inhalation study)	Male	0.044	0.13	8.0	0.1 <sup>a</sup>
	Female	0.040	0.12	5.0	3.0
Sprague-Dawley rats (inhalation study)	Male - low dose	0.638	0.19	4.0	2.0
	Male - high dose	0.433	0.13	4.0	2.0
	Female - low dose	0.485	0.200	3.0	0.1 <sup>a</sup>
	Female - high dose	0.321	14	3.0	0.1 <sup>a</sup>
Sprague-Dawley rats (gavage study)	Male - low dose	0.632	0.19	4.0	2.0
	Male - high dose	0.405	0.12	4.0	2.0
	Female - low dose	0.445	0.18	3.0	0.1 <sup>a</sup>
	Female - high dose	0.301	0.13	3.0	0.1 <sup>a</sup>
Wistar rats (drinking water study)	Male	0.436	0.14	4.0	2.0
	Female	0.245	0.11	3.0	0.1 <sup>a</sup>

**Scaled Parameters**

$$QP = QPC * BW^{0.75}$$

$$QC = QCC * BW^{0.75}$$

$$QR = QRC * QC$$

$$QF = QFC * QC$$

$$QS = QSC * QC$$

$$QL = QLC * QC$$

$$QC = QL + QF + QS + QR$$

Note: Since all of the input parameters are subject to modification by the Monte Carlo analysis, it is necessary to recompute the total blood flow in order to maintain mass balance (where QCC, QLC, QFC, QSC, and QRC are subject to modification).

$$VS = VSC * BW$$

$$VF = VFC * BW$$

$$VR = VRC * BW$$

$$VL = VLC * BW$$

$$VMAX1 = VMAX1C * BW^{0.75}$$

$$VMAX1M = VMAX1C * BW^{0.75} * 1000.0 / MW$$

$$VMAX2 = VMAX2C * BW^{0.75}$$

$$VMAX2M = VMAX2C * BW^{0.75} * 1000.0 / MW$$

$$KCO2 = KCO2C / BW^{0.25}$$

$$KGSM = KGSMC / BW^{0.25}$$

$$KFEE = KFEEC / BW^{0.25}$$

$$GSO = VLC * BW^{0.75} * GSO$$

$$KB = KBC / BW^{0.25}$$

$$KO = KOC * BW^{0.75}$$

## Table B-4. Strain/study-specific parameter values (continued)

### Principal Dose Surrogate

RISK = (Total amount metabolized)/VL

### Other Dose Surrogates

RISK1 = (Total amount metabolized by pathway 1)/VL

RISKG = (Total amount reacted with glutathione)/VL

RISKM = (Total amount binding to cellular materials)/VL

RISKT = Lifetime Average Daily Dose based on RISK

RISKN = Lifetime Average Daily Dose based on RISKM

RISKR = Lifetime Average Daily Dose based on RISKG

RISKT1 = Lifetime Average Daily Dose based on RISK1

<sup>a</sup>The value of this parameter was normally set to zero. It was only set to 0.1 for the PBPK\_SIM runs. The variance for this parameter was set to zero in the PBPK\_SIM runs.

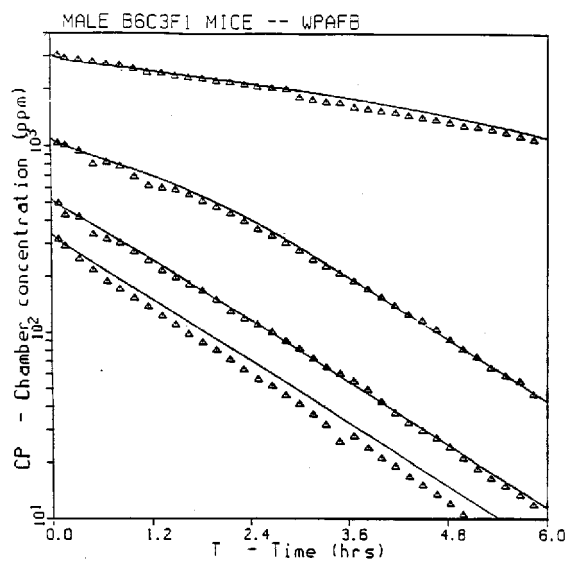

(a)

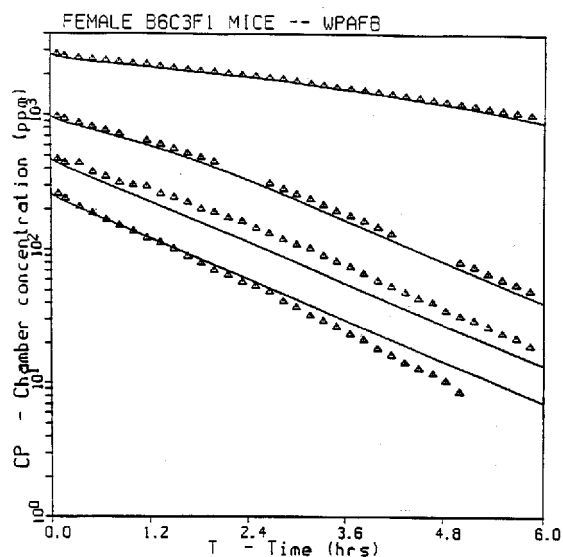

(b)

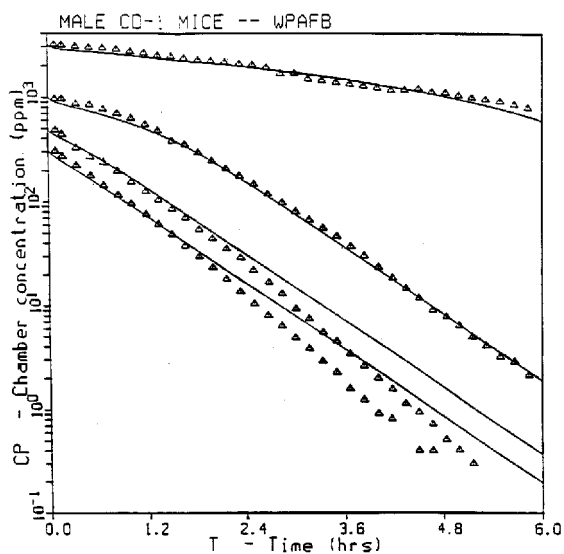

(c)

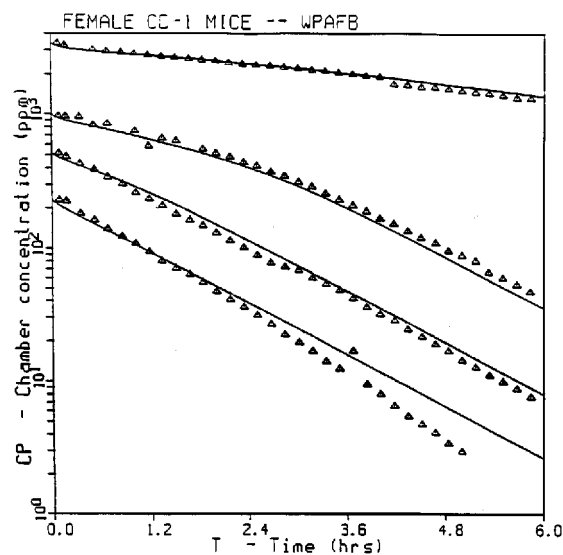

(d)

**Figure B-1. Model predictions (lines) and experimental data (symbols) for the chamber concentration during exposure of mice or hamsters to VC in a closed, recirculated chamber (Clement, 1990): (a) male B6C3F1 mice; (b) female B6C3F1 mice; (c) male CD-1 mice; (d) female CD-1 mice.**

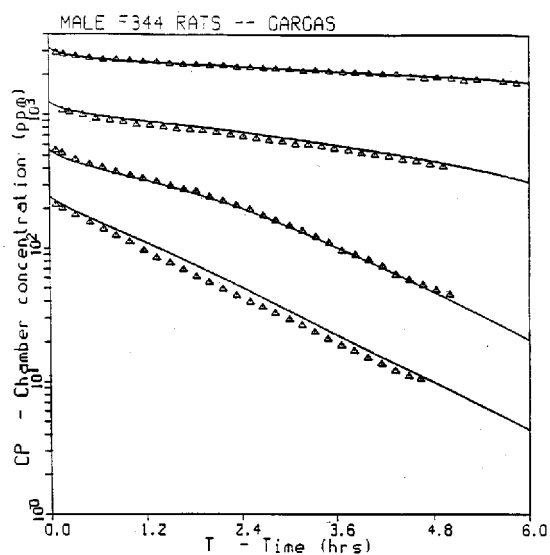

(a)

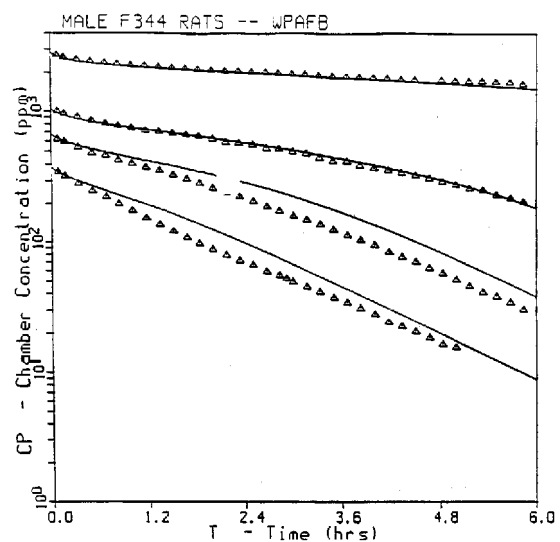

(b)

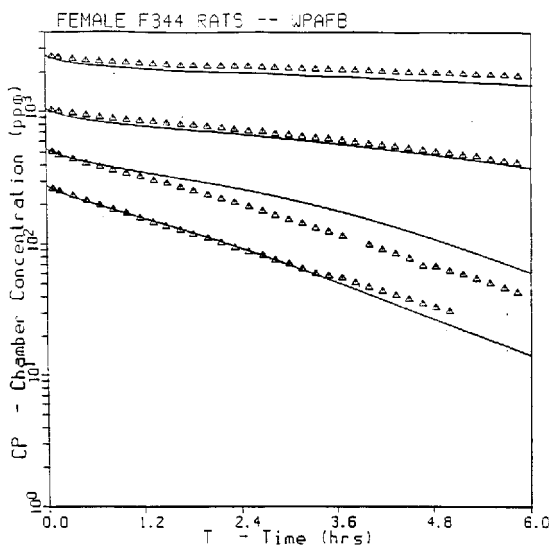

(c)

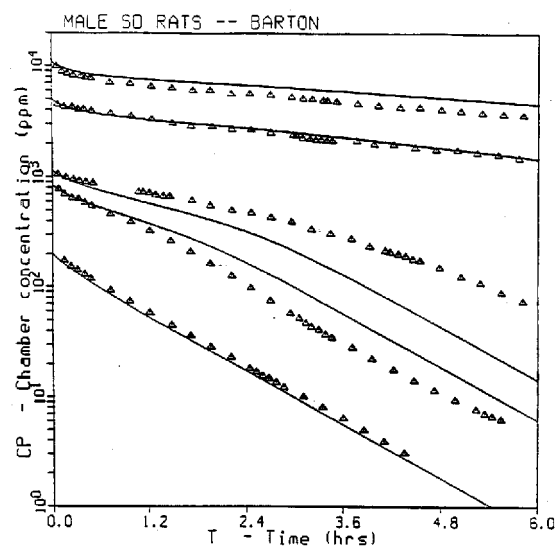

(d)

**Figure B-2. Model predictions (lines) and experimental data (symbols) for the chamber concentration during exposure of rats to VC in a closed, recirculated chamber: (a) male F344 rats (Gargas et al., 1990); (b) male F344 rats (Clement, 1990); (c) female F344 rats (Clement, 1990); (d) male Sprague-Dawley rats (Barton et al., 1995).**

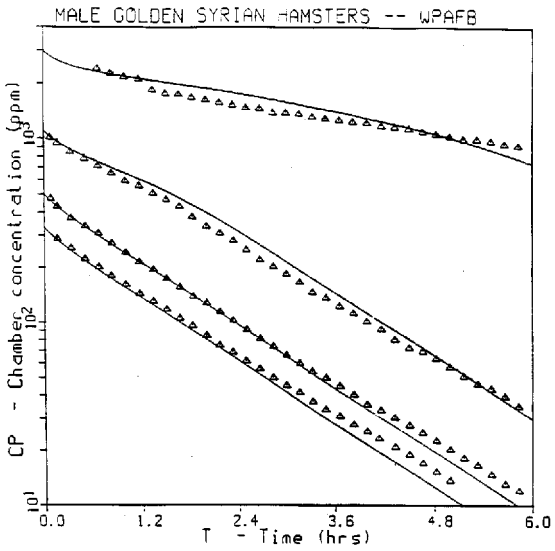

(e)

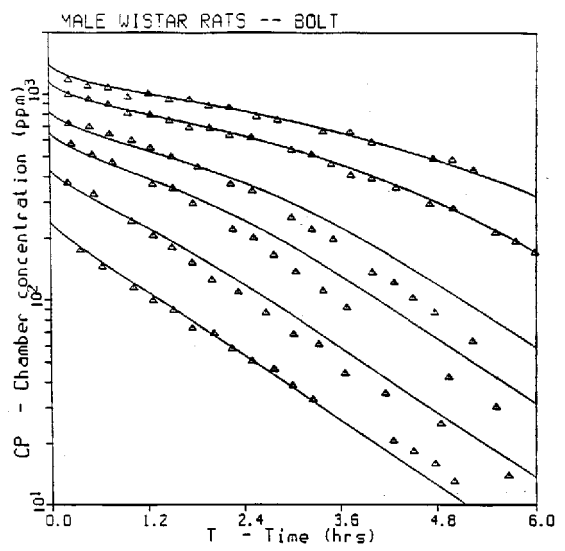

(f)

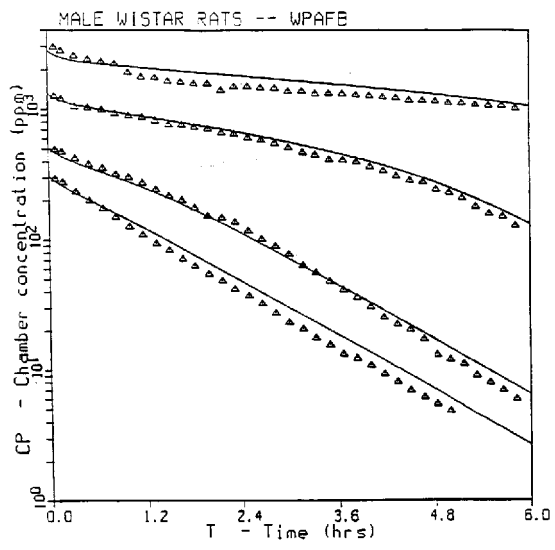

(g)

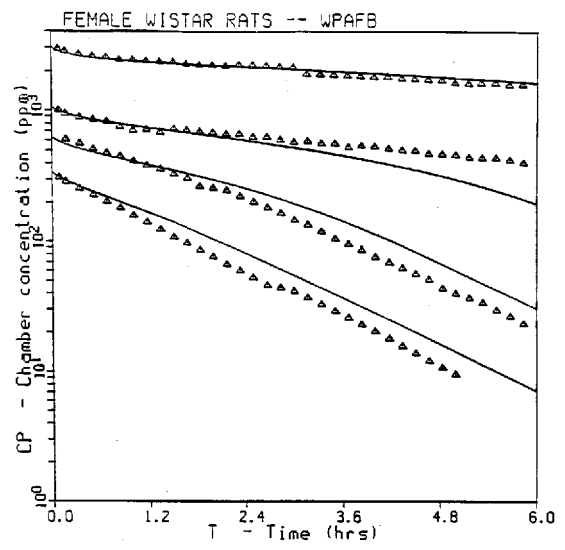

(h)

Figure B-2 (continued): (e) female SD rats (Clement, 1990); (f) male Wistar rats (Bolt et al., 1977); (g) male Wistar rats (Clement, 1990); (h) female Wistar rats (Clement, 1990).



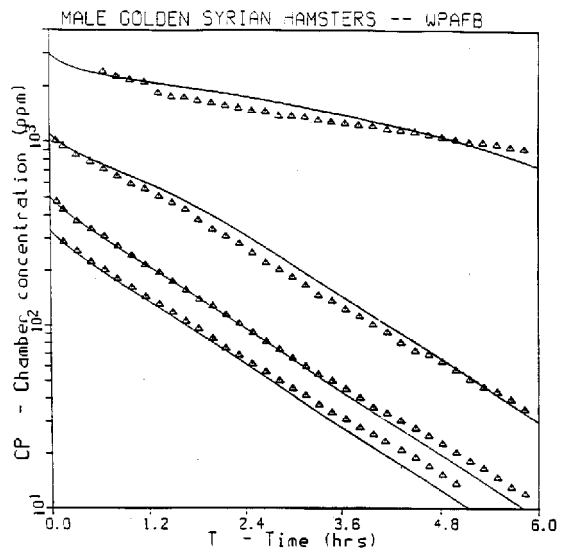

(i)

Figure B-2 (continued): (i) male Golden Syrian hamsters (Clement, 1990).

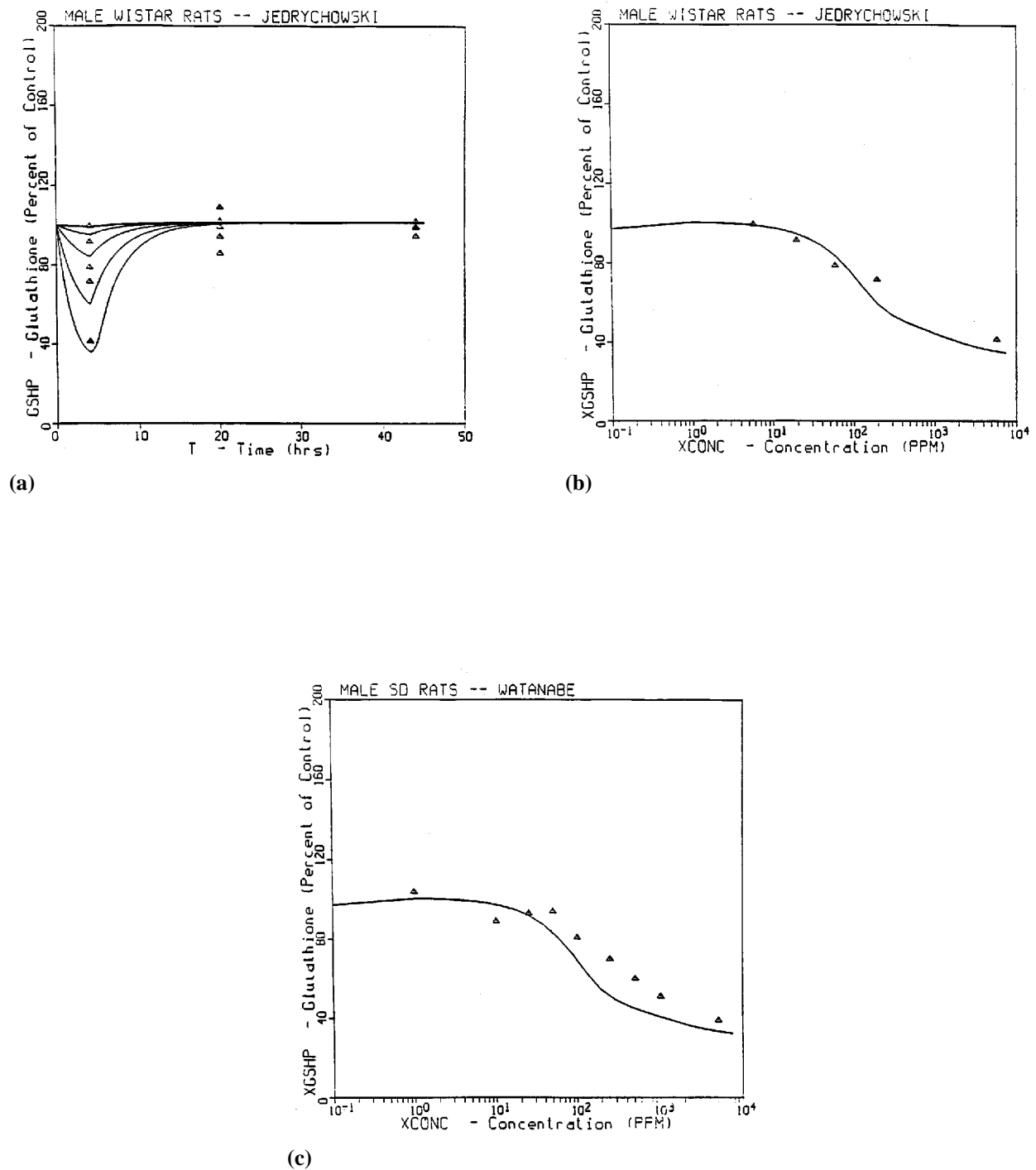

**Figure B-3. Model-predicted (lines) and experimentally determined (symbols): (a) GSH concentrations (% controls) after 4-hr inhalation exposures to VC at concentrations of (top to bottom) 15, 50, 150, 500, and 15,000 mg/m<sup>3</sup> (Jedrichowski et al., 1985); (b) glutathione concentrations (% control animal levels) immediately following 4-hr inhalation exposures to VC (Jedrichowski et al., 1985); (c) GSH concentrations (% controls) immediately following 6-hr inhalation exposures to VC (Watanabe et al., 1976c).**

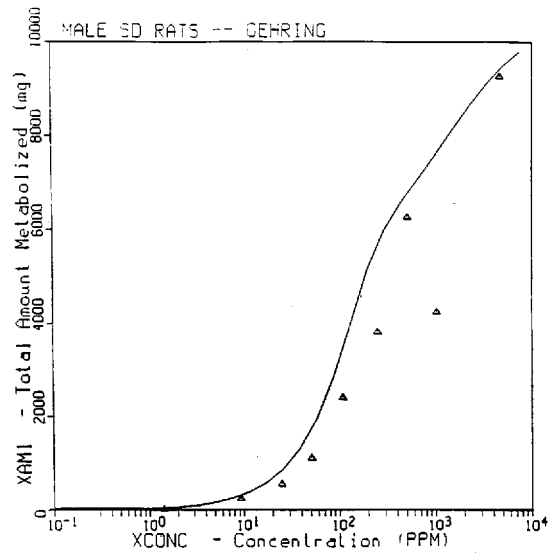

Figure B-4. Model-predicted (lines) and experimentally determined (symbols) total amount metabolized during 6-hr inhalation exposures to VC (Gehring et al., 1978).

results, indicating that the kinetic parameters optimized by the model were valid for the species/strain/sex over a wide range of external air concentrations.

Parameterization of the P450 metabolism pathways in the human was accomplished as follows: There is no evidence of high-capacity, low-affinity P450 metabolism for chlorinated ethylenes in the human; therefore, VMAX2C in the human was set to zero. The ratio of VMAX1C to KM1 could be estimated by fitting the model to data from closed chamber studies with human subjects (Buchter et al., 1978) in a manner entirely analogous to the method used for the animal closed chamber analysis. The result of this process is shown in Figures B-6a and B-6b. The precision and sensitivity of the estimate of VMAX1C/KM1 can be evaluated by a comparison of the several model runs shown in these figures, as each simulation was based on a separate designation of VMAX1C. It can be seen that the estimate of VMAX1C/KM1 in each subject can be determined to within about 30% to 50%, but that the ratio varies between the two subjects, as are represented by the two lines on Figure B-6b. This variability of CYP2E1 activity in the human is not surprising; several studies have demonstrated a variability of human CYP2E1 activity of roughly an order of magnitude (Reitz et al., 1989; Sabadie et al., 1980). This wide variability is not observed in the inbred strains typically used in animal studies; for example, the coefficient of variation (standard deviation divided by the mean) for CYP2E1 activity in rats in one of these same studies was only 14% (Sabadie et al., 1980). This wide variability in human CYP2E1 activity is an important consideration for estimating the potential difference between average population risk and individual risk in a human cancer risk assessment for materials like VC, whose carcinogenicity depends on metabolic activation.

In order to obtain separate estimates of VMAX1C and KM1 in the human, higher exposure concentration closer to metabolic saturation would be required. Fortunately, cross-species scaling of CYP2E1 between rodents and humans appears to follow allometric expectations for metabolism very closely; that is, the metabolic capacity scales approximately according to body weight raised to the 3/4 power (Andersen et al., 1987a). Support for the application of this principle to VC can be obtained from data on the metabolism of VC in nonhuman primates (Buchter et al., 1980). Based on data for the dose-dependent metabolic elimination of VC in the rhesus monkey, the maximum capacity for metabolism can be estimated to be about 50  $\mu\text{mol/hr/kg}$ . This equates to a VMAX1C (the allometrically scaled constant used in the model) of approximately 4 mg/hr for a 1 kg animal, which is in the same range as those estimated for rodents from the closed chamber exposure data. The similarity of VMAX1C in humans and rats is also supported by an *in vitro* study that found the activity of human microsomes to be 84% of the activity of rat microsomes. Based on these comparisons, the human VMAX1C was set to the primate value and KM1 was calculated using this value of VMAX1C and the ratio of VMAX1C/KM1 obtained from the closed chamber analysis. The ability of the resulting human model to reproduce inhalation exposure data (Buchter et al., 1978; Baretta et al., 1969) is shown in Figures B-6c, B-6d, and B-7. Note that the reproduction of parent chemical concentrations for a constant concentration inhalation exposure is not a particularly useful test of the accuracy of the metabolism parameters in a PBPK model of a volatile compound. The results of Figure B-7, in which three conditions of metabolism were run for each concentration (none, optimized value and twice the optimized value for VMAX1C), indicate that the discrepancies or agreement between the model and the data are due primarily to details of the physiological

description of the individual, such as fat content, ventilation rate, blood/air partition, etc., rather than rate of metabolism.

Figures B-1 through B-4, B-6, and B-7 provide a basis to favorably evaluate the capability of the inhalation portion of the model and its parameters to reproduce and predict results from experimental inhalation data. There are, however, limited data to judge the capability and performance of the oral portion of the model. Figures B-8a, b, and c are data and model simulations of blood levels of VC after gavage administration of VC at the doses indicated. Modeled simulations provide poor fits to these depuration data, which are themselves problematic. A similarly poor data fit was observed with expiration of carbon dioxide in rats following oral dosing with VC (Figure B-5). There are no experimental data from drinking water or dietary studies to judge the performance of the oral portion of the model.

The significance to the overall assessment of having experimental data to judge capabilities of a PBPK model relates directly to the confidence in model output, i.e., the dose metrics. Based on the existing experimental data, a much higher confidence would be placed in dose metrics derived from inhalation studies than for those derived from oral studies. Strategic programming within the PBPK model can, however, offset this lack of confidence. This would be done by maximizing the potential of an oral dose for expressing toxicity, i.e., maximizing the conversion of the parent dose to the reactive species. This has been accomplished in the oral dose inputs by designating VC uptake from the dietary/drinking water route as zero-order (i.e., independent of concentration) and occurring over a 24-hr period. Thus, for oral inputs the model calculates total VC uptake spread out over a period where the concentrations would not exceed the capacity of the metabolic processes to work at maximum efficiency (i.e., where  $V_{max}/K_m$  are linear). These designations would produce the maximum value of the dose metric (mg metabolite/L liver) and may be viewed as being conservative or “worst case” with respect to what may actually occur during an oral dose. Coupled with the use of the same hepatic metabolic processes for both inhalation and oral inputs, this strategy is considered to increase the confidence in dose metrics derived from oral inputs.

## **B.5. COMPARISON OF RISK ASSESSMENTS FOR VC INHALATION**

The model just described was used to calculate the pharmacokinetic dose metrics for angiosarcoma in the most informative of the animal bioassays (Maltoni et al., 1981, 1984; Feron et al., 1981), as well as for human inhalation exposure. The results of these calculations are shown in Table B-5. The 95% upper confidence limits (UCLs) on the human risk estimates for lifetime exposure to 1 ppm VC were then calculated on the basis of each of the sets of bioassay data, using the 1-hit version of the LMS model, and the resulting risk estimates are shown in Table B-6. Because saturation of metabolism occurs well above the 1 ppm concentration in the human, estimates of risk below 1 ppm can be adequately estimated by assuming linearity (e.g., the risk estimates for lifetime exposure to  $1 \mu\text{g}/\text{m}^3$  of VC would range from approximately  $0.2 \times 10^{-6}$  to  $6 \times 10^{-6}$ ). It should be noted that although the animal studies represent both inhalation and oral exposure, the risk predictions in each case are for human inhalation exposure.

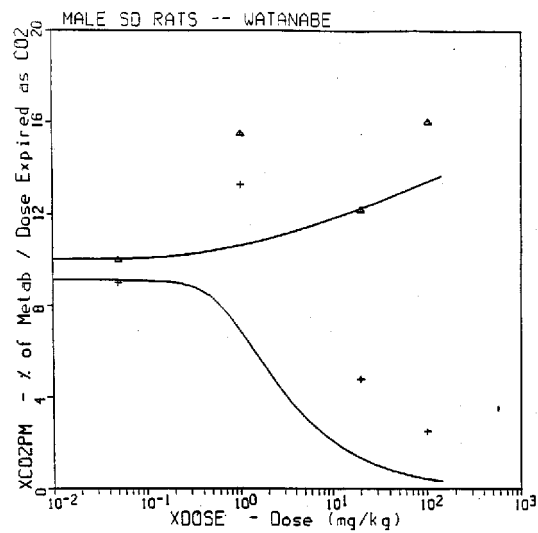
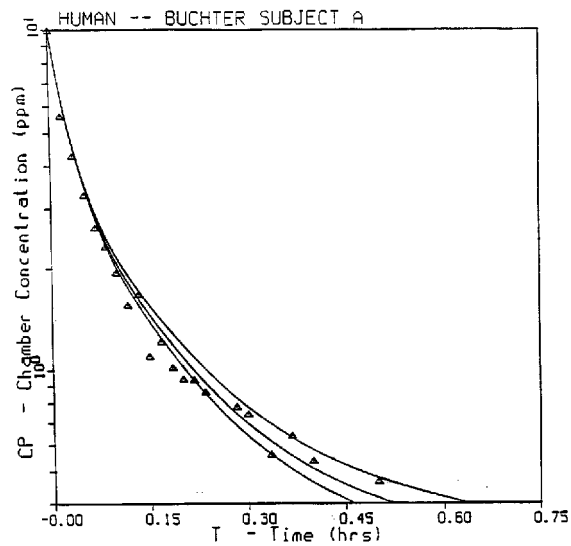
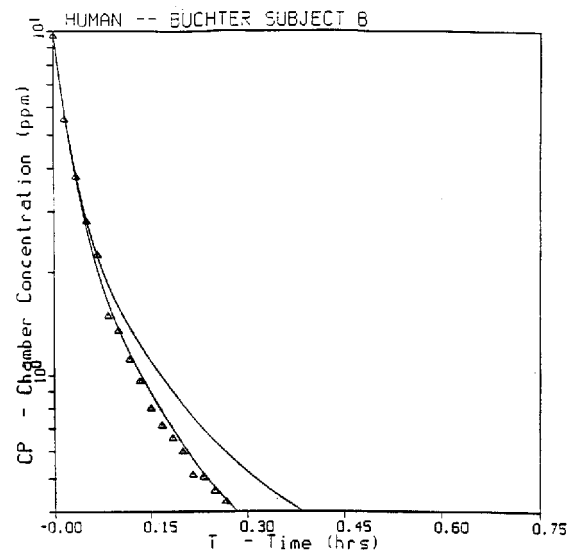

Figure B-5. Model-predicted (lines) and experimentally determined (symbols) total expired CO<sub>2</sub>, as a percent of total metabolism (upper line and symbols) and as a percent of dose (lower line and symbols), following oral dosing with VC in corn oil (Watanabe and Gehring 1976).



(a)



(b)

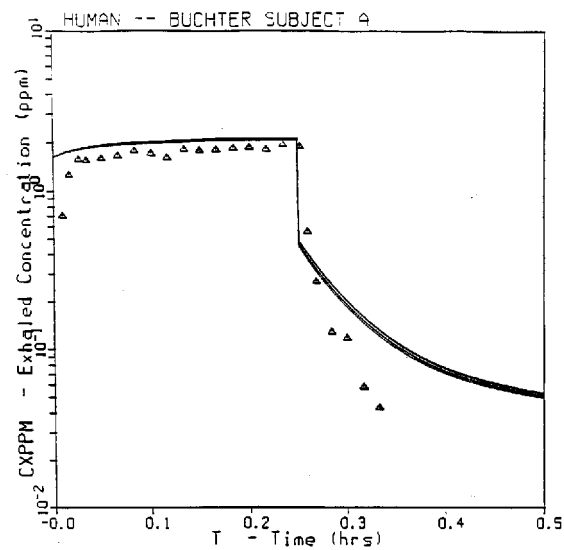

(c)

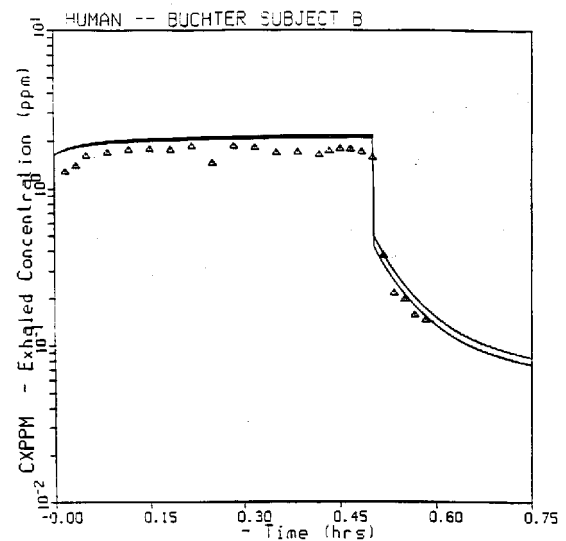

(d)

Figure B-6. Model predictions (lines) and experimental data (symbols) for the chamber concentration during exposure of human subjects to VC in a closed, recirculated chamber (Buchter et al., 1978). (a) The lines show the model predictions for (left to right)  $V_{MAX1C} = 2.5, 3.5,$  and  $4.5$ . The rest of the model parameters are those shown for the human in Table A-1. (b) The lines show the model predictions for (left to right)  $V_{MAX1C} = 10$  and  $3.5$  (compare to Subject A in Fig. B-6a). The rest of the model parameters are those shown for the human in Table A-1. (c) The lines show the model predictions for (top to bottom)  $V_{MAX1C} = 2.5, 3.5,$  and  $4.5$ . The rest of the model parameters are those shown for the human in Table A-1. (d) The lines show the model predictions for (top to bottom)  $V_{MAX1C} = 10$  and  $3.5$ . The rest of the model parameters are those shown for the human in Table A-1.

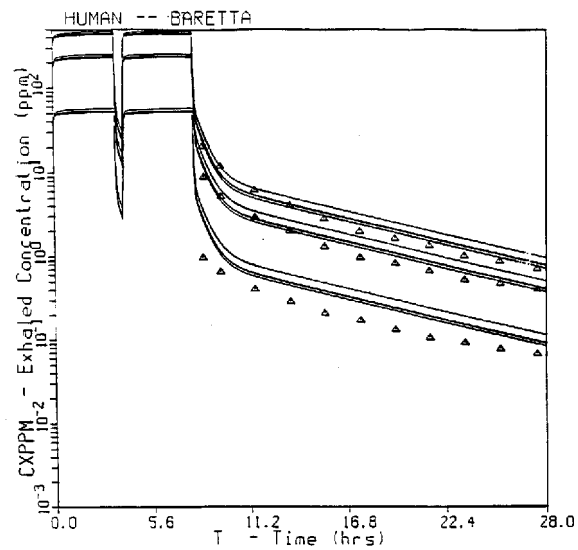
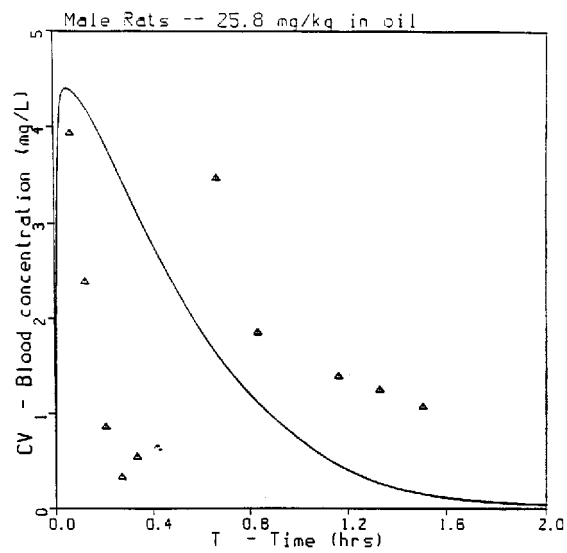
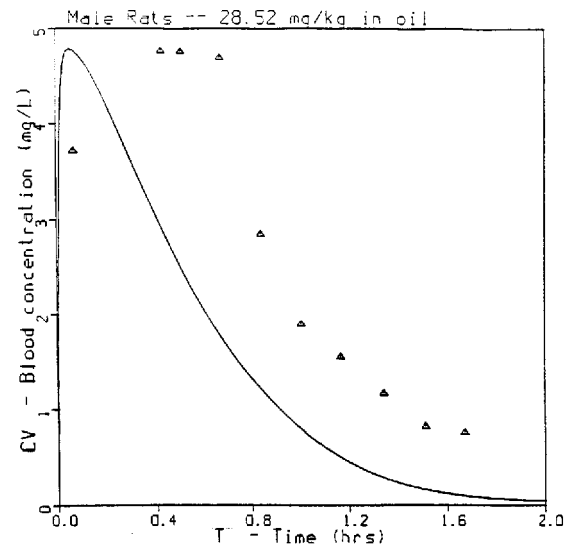

Figure B-7. Model predictions (lines) and experimental data (symbols) for the exhaled air concentration following inhalation exposure of human subjects for 8 hr (with a 30-min break for lunch) to a constant concentration of (top to bottom) 492, 261, and 59 ppm VC (Baretta et al., 1969). At each concentration the three lines show the model predictions for (top to bottom) VMAX1C = 0, 4, and 8. The rest of the model parameters are those shown for the human in Table A-1.





(a)



(b)

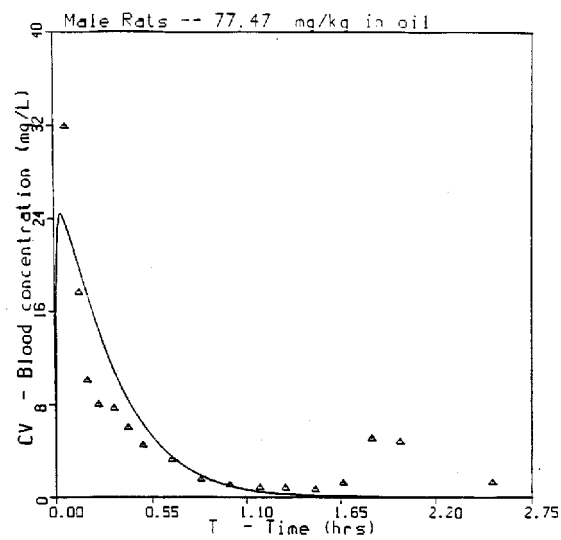

(c)

Figure B-8. Model-predicted (lines) and experimentally determined (symbols) blood concentrations following oral dosing with VC in corn oil (Withey et al., 1976): (a) 25.8 mg/kg, (b) 28.52 mg/kg, (c) 77.47 mg/kg. The KA (absorption rate constant) used was (a) 2, (b) 2, (c) 4.

**Table B-5. Dose metric values for angiosarcomas**

						Daily dose metric	Lifetime average delivered dose
Reference	Route	Species	Duration	Dose	Incidence	RISK	RISK
Occupational exposure	Inhalation	Human	8 hr/d, 5 d/wk, 50 wk/yr for 10 of 70 yr	50 ppm		26.574	2.607
				100 ppm		51.685	5.071
				200 ppm		97.509	9.567
				500 ppm		202.356	19.854
				1,000 ppm		300.965	29.530
				2,000 ppm		386.295	37.902
			8 hr/d, 5 d/wk, 50 wk/yr for 20 of 70 yr	50 ppm		26.574	5.215
				100 ppm		51.685	10.142
				200 ppm		97.509	19.134
				500 ppm		202.356	39.709
				1,000 ppm		300.965	59.059
				2,000 ppm		386.295	75.804
	Drinking water	Continuous exposure	1 ppm in air <sup>a</sup>		1.74	1.74	
			0.028 mg/kg/d (1 mg/L in drinking water)		0.581	0.581	
Maltoni et al., 1981, 1984 (BT4) <sup>b</sup>	Inhalation	Swiss Albino mice (M)	4 hr/d, 5 d/wk for 30 of 104 wk	0 ppm	0/80		
				50 ppm	1/30	161.924	33.363
				250 ppm	9/30	775.615	159.811
				500 ppm	6/30	1,245.220	256.570
				2,500 ppm	6/29	1,434.800	295.632
				6,000 ppm	2/30	1,479.270	304.795
				10,000 ppm	1/26	1,505.580	310.216
Maltoni et al., 1981, 1984 (BT4) <sup>b</sup> (continued)	Inhalation	Swiss Albino mice (F)	4 hr/d, 5 d/wk for 30 of 104 wk	0 ppm	0/70		
				50 ppm	0/30	156.907	32.330
				250 ppm	9/30	673.015	138.671
				500 ppm	8/30	887.253	182.813
				2,500 ppm	10/30	1,197.670	246.773
				6,000 ppm	11/30	1,341.160	276.338
				10,000 ppm	9/30	1,405.330	289.560

**Table B-5. Dose metric values for angiosarcomas (continued)**

						Daily dose metric	Lifetime average delivered dose
Reference	Route	Species	Duration	Dose	Incidence	RISK	RISK
Maltoni et al., 1981, 1984 (BT1, BT2, and BT15) <sup>c</sup>	Inhalation	Sprague-Dawley rats (M)	4 hrs/d, 5 d/wk for: 52 of 147 wk (BT15)	0 ppm	0/108		
				1 ppm	0/48	2.398	0.606
				5 ppm	0/43	11.985	3.028
				10 ppm	0/42	23.933	6.047
				25 ppm	1/41	59.552	15.047
			52 of 135 wk (BT1)	50 ppm	0/26	117.989	32.463
			52 of 143 wk (BT2)	100 ppm	0/37		59.70
				150 ppm	1/36		85.90
				200 ppm	7/42		107.39
			52 of 135 wk (BT1)	250 ppm	2/26	473.425	130.254
				500 ppm	6/28	593.928	163.409
				2,500 ppm	7/24	803.198	220.986
				6,000 ppm	10/25	911.248	250.714
			Maltoni et al., 1981, 1984 (BT1, BT2, and BT15) <sup>b</sup> (continued)	Inhalation	Sprague-Dawley rats (F)	4 hrs/d, 5 d/wk for: 52 of 147 wk (BT15)	0 ppm
1 ppm	0/55	2.343					0.592
5 ppm	0/47	11.698					2.956
10 ppm	1/46	23.332					5.895
25 ppm	4/40	57.838					14.614
52 of 135 wk (BT1)	50 ppm	1/29				113.653	31.270
52 of 143 wk (BT2)	100 ppm	1/43					55.95
	150 ppm	5/46					76.67
	200 ppm	5/44					90.0
52 of 135 wk (BT1)	250 ppm	2/26				375.989	103.447
	500 ppm	6/28				425.029	116.939
	2,500 ppm	7/24				488.374	134.367
	6,000 ppm	10/25				522.359	143.718

**Table B-5. Dose metric values for angiosarcomas (continued)**

						Daily dose metric	Lifetime average delivered dose
Reference	Route	Species	Duration	Dose	Incidence	RISK	RISK
Maltoni et al., 1981, 1984 (BT11)	Gavage	Sprague-Dawley rats (M)	5 d/wk for 52 of 136 wk	0 mg/kg/d	0/60		
				0.021 mg/kg/d	0/15	0.488	0.133
				0.214 mg/kg/d	0/15	4.962	1.355
				0.714 mg/kg/d	1/21	16.373	4.472
				2.38 mg/kg/d	0/34	50.390	13.762
				11.9 mg/kg/d	4/39	133.231	36.387
				35.7 mg/kg/d	8/36	203.079	55.463
		Sprague-Dawley rats (F)	5 d/wk for 52 of 136 wk	0 mg/kg/d	0/73		
				0.021 mg/kg/d	0/18	0.477	0.130
				0.214 mg/kg/d	1/19	4.835	1.321
				0.714 mg/kg/d	2/29	15.800	4.315
				2.38 mg/kg/d	0/37	45.330	12.380
				11.9 mg/kg/d	6/34	102.763	28.066
				35.7 mg/kg/d	9/35	143.866	39.291
Feron et al., 1981	Diet	Wistar rats (M)	135 wk	0 mg/kg/d	0/55 (0/55) <sup>d</sup>		
				1.7 mg/kg/d	0/58 (2/58)	39.539	39.539
				5.0 mg/kg/d	6/56 (11/56)	116.103	116.103
				14.1 mg/kg/d	27/59 (41/59)	325.845	325.845
		Wistar rats (F)	144 wk	0 mg/kg/d	0/57 (2/57)		
				1.7 mg/kg/d	0/58 (28/58)	38.611	38.611
				5.0 mg/kg/d	2/59 (49/59)	113.243	113.243
				14.1 mg/kg/d	9/57 (56/57)	316.628	316.628

<sup>a</sup>The dose metric reported here differ from those shown in Table A-3, because of use of different breathing rates. The standard EPA breathing rate was used to calculate the dose metric shown in Table A-3, and that value was used for the risk calculations.

<sup>b</sup>The denominator for the incidence data is the total number of mice, as used by Chen and Blancato (1989).

<sup>c</sup>The denominator is the number of rats alive when the first angiosarcoma was observed, as used by Chen and Blancato (1989). However, the male and female incidence data shown here differ from that reported by Chen and Blancato (1989), after verification with the original study (Maltoni et al., 1984).

<sup>d</sup>Number in parentheses is the combined incidence of liver angiosarcomas, hepatocellular carcinomas, and neoplastic nodules.

**Table B-6. Human risk estimates for inhalation exposure based on angiosarcoma incidence in oral and inhalation animal assays and various dose metrics**

	Risk based on dose metric RISK (95% UCL RISK/1,000/ppm) <sup>a</sup>	P	Fit
	RISK		
Maltoni et al. (1981, 1984) BT4 - Inhalation			
Male mice	1.52	0.005	Reject
Female mice	3.27	0.5	Good
Maltoni et al. (1981, 1984) BT15/BT1 - Inhalation			
Male rats	5.17	0.1	Poor
Female rats	2.24	0.2	OK
Maltoni et al. (1981, 1984) BT11- Gavage			
Male rats	8.68	0.3	OK
Female rats	15.70	0.07	Poor
Feron et al. (1981) - Diet			
Male rats	3.05	0.005	Reject
Female rats	1.10	0.4	Good

<sup>a</sup>Risks were calculated using the 1-hit version of the LMS model.

There are no consistent differences between risk estimates based on male and female animals exposed via inhalation, with the female-based risks being higher than the male-based risks in some studies and lower in others, but generally agreeing within a factor of 2 to 3. The human risk estimates based on inhalation studies with mice ( $0.2 \times 10^{-6}$  to  $1.7 \times 10^{-6}$  per  $\mu\text{g}/\text{m}^3$ ) agree very well with those based on inhalation studies with rats ( $0.6 \times 10^{-6}$  to  $2.4 \times 10^{-6}$  per  $\mu\text{g}/\text{m}^3$ ), demonstrating the ability of pharmacokinetics to integrate dose-response information across species.

The risks estimated from the dietary administration of VC based upon liver angiosarcomas alone ( $0.4 \times 10^{-6}$  to  $1.2 \times 10^{-6}$  per  $\mu\text{g}/\text{m}^3$ ) are similar to those obtained from the inhalation bioassays. However, the risk estimates based on combined incidence of angiosarcoma, hepatocellular carcinoma, and neoplastic nodules are increased about 16-fold. Oral gavage of VC in vegetable oil also resulted in about a sixfold greater risk than the risk based upon either angiosarcomas alone in the oral exposures, or the inhalation exposure. It has previously been noted in studies with chloroform that administration of the chemical in corn oil results in more marked hepatotoxic effects than when the same chemical is provided in an aqueous suspension (Bull et al., 1986). It has also been demonstrated that administration of corn oil alone leads to an increase in peroxisomal oxidative enzyme activity in rats (DeAngelo et al., 1989). The toxicity and oxidative environment created in the liver by continual dosing with large volumes of vegetable oil could serve to potentiate the effects of genotoxic carcinogens in the liver. In support of this suggestion, Newberne et al. (1979) found that incorporation of corn oil into the diet increased the yield of aflatoxin B<sub>1</sub>-induced tumors in rats. A similar phenomenon could be responsible for the apparently higher potency of VC when administered by oil gavage compared to incorporation in the diet.

The p-values for the goodness of fit of the 1-stage LMS model with the pharmacokinetic dose metric RISK to the bioassay data are generally acceptable, with only two data sets meeting the criterion for rejection of the model at  $p=0.05$ . The p-values for goodness of fit with the different metrics (including RISK, RISKM, and RISKG) were in general very similar; therefore only a single representative p-value is shown for each bioassay data set. The similarity of the p-values makes it impossible to select one metric over another on the basis of agreement with the dose-response of the incidence data. Fortunately, the risks predicted for each of the studies by the various dose metrics are quite similar. The RISKM metric, which is the most biologically plausible, predicts slightly lower risks than the other two dose metrics; the RISKG metric, which is probably the least likely, predicts the highest risks.

### **B.5.1. Epidemiological Analysis of Vinyl Chloride Carcinogenicity**

In order to evaluate the plausibility of the risks predicted on the basis of the animal data, risk calculations were also performed on the basis of available epidemiological data. A linear relative risk dose-response model was used for analysis of the human data:

$$O = E(1 + \alpha*d),$$

where O is the observed number of liver tumors, E is the expected number of such tumors apart from any exposure, d is a cumulative dose metric (see discussion below) and  $\alpha$  is a potency parameter that can be estimated by maximum likelihood techniques. Then it follows that the lifetime probability of liver cancer, P(d), can be estimated by

$$P(d) = P_0(1 + \alpha*d),$$

where  $P_0$  is the background probability of liver cancer death. Actually, the lifetime risk should be estimated by a lifetable method, but the above approximation should be close enough for the purpose of these comparative potency estimates.

Now suppose that for a particular exposure scenario (e.g., a VC atmospheric concentration of 50 ppm, 8 hr a day, 5 days per week), the PBPK model predicts an average daily internal dose metric of X. Then the cumulative exposure that should be used in the dose-response model is X\*Y, where Y is the number of years of such exposure. Note that to compute this PBPK-based cumulative dose, one must have an estimate of the “typical” workplace exposure concentration for each subcohort, separate from the number of years of exposure for the subcohort, rather than just a cumulative dose estimate. Only after the internal dose has been calculated with the PBPK model can the duration of exposure be applied to get a cumulative internal dose.

To obtain pharmacokinetic human-based risk estimates, the PBPK model was run for the exposure scenario appropriate to each of the selected subcohorts from the studies discussed below. The resulting internal dose metrics (which included RISKM and RISKG for comparison with RISK) were multiplied by the appropriate durations to obtain the cumulative internal doses, which were then input into the relative risk model along with the observed and expected liver cancer deaths for each subcohort to get an estimate of the maximum likelihood estimate and 95% confidence interval for  $\alpha$ . Then, to determine the risk associated with a continuous lifetime exposure to 1 ppm for comparison with the animal results, the PBPK model was run for a 1 ppm continuous exposure and the average daily value of the various internal dose metrics was calculated. Multiplying the dose metrics by 70 years gives the appropriate cumulative dose for the relative risk model. For a  $P_0$  sufficiently small (which it should be for liver cancer in humans), the extra risk for a lifetime exposure to 1 ppm VC will be approximately:

$$P_0*\alpha*d_1,$$

where  $d_1$  = cumulative internal dose for 1 ppm continuous exposure. Using the 95% upper bound on the estimate for  $\alpha$  provides a 95% upper confidence limit on the lifetime risk per ppm for comparison with the animal-based results obtained with the LMS model.

Three epidemiological studies that associated increased liver cancer with exposure to VC, and that provide sufficient information to support separate exposure concentration and duration estimates (as opposed to just cumulative exposure estimates), were selected for this study: Fox and Collier (1977), Jones et al. (1988), and Simonato et al. (1991). For each study, risk was calculated as a linear function of the product of duration and cumulative tissue dose.

### B.5.1.1. Fox and Collier (1977)

This study is probably the best with respect to providing information about duration of employment for different exposure-level groupings (see their Table 2). The average exposure levels were estimated to be 12.5, 70, and 300 ppm for the low, medium, and high exposure groups, respectively (Clement, 1987); for comparison Chen and Blancato (1989) estimated averages of 11, 71, and 316 ppm. For the constant exposure groups, these concentrations were input into the human PBPK model, assuming 8 hr/day and 5 days/week exposure, to get average daily internal dose metrics, which were then multiplied by the duration averages (assumed to be 5, 15, and 27 years) to get cumulative doses. For the intermittent exposure groups, exposure for 2 hr/day, 5 days/week was assumed.

Thus, for each exposure level, six values for the cumulative dose were calculated: one for each of three exposure durations, under both the intermittent and constant exposure scenarios. Because observed and expected numbers of liver cancers were reported only by exposure group, not broken down by duration (see their Table 9), an overall average dose was needed for each exposure level. Therefore, a weighted average of the six values for the cumulative dose was calculated for each exposure group (high, medium, and low), averaging across the duration of exposure categories and constant versus intermittent groups. The weighting was performed using the number of workers in the various subcohorts (their Table 2).

The resulting weighted dose estimates for each internal dose metric were then input into the relative risk model along with the observed and expected tumors reported by the investigators:

<u>Cumulative dose</u>	<u>Obs.</u>	<u>Exp.</u>
Average low dose	1	0.75
Average medium dose	1	0.77
Average high dose	2	0.13

The resulting risk estimates for each pharmacokinetic dose metric are shown in Table B-7. The range of risk estimates reflects uncertainty in the appropriate value for  $P_0$ , the background probability of death from liver cancer. The lower risk estimate was calculated using the value of  $P_0$  derived in the Fox and Collier study, while the higher risk estimate was calculated using an estimate of the lifetime liver cancer mortality rate in the U.S. population (Chen and Blancato, 1989). Note that the “range” of risk estimates reflects the results corresponding to two assumptions about the background rate of liver cancer in humans, rather than reflecting a true range. An important factor in interpreting these results is that the classification into exposure groups in this study was based on the maximum exposure level that a worker experienced. This leads to overestimation of cumulative exposure, particularly for the workers in the medium and high groups, and therefore a probable underestimation of risk when using the linear relative risk model.



### B.5.1.2. Jones et al. (1988)

This study was an update of the cohort studied by Fox and Collier. Unfortunately, it does not provide as much information about duration of exposure, so the analysis must be limited to the autoclave workers. For those workers, four duration-of-employment categories are given (see their Table 4); in the present analysis estimated average durations of 1.5, 3, 7.5, and 15 years were used. Their Table 1 shows that the autoclave workers had exposures ranging between 150 and 800 ppm at various points in time. A value of 500 ppm was used in the PBPK model (8 hr/day, 5 days/week) to get the average daily internal doses. The average daily internal doses were then multiplied by the four average durations of exposure to get cumulative doses for the four groups:

<u>Cumulative dose group</u>	<u>Cumulative Dose (units of RISK dose metric)</u>	<u>Obs.</u>	<u>Exp.</u>
Low	230 mg/L × year	0	0.07
Mid 1	461 mg/L × year	1	0.08
Mid 2	1,152 mg/L × year	2	0.08
High	2,304 mg/L × year	4	0.15

Note that the different cumulative dose groups here reflect different exposure durations to the same average VC concentrations. Insufficient data were presented in this paper to identify the number of workers exposed to different exposure levels for different durations.

The resulting risk estimates for each pharmacokinetic dose metric are shown in Table B-7. In each case the lower risk estimate was calculated using the value of  $P_0$  derived in the Jones et al. (1988) study, while the higher risk estimate was calculated using an estimate of the lifetime liver cancer mortality rate in the U.S. population (Chen and Blancato, 1989). As with the Fox and Collier (1977) study, it is important to note that workers were classified into job categories based on the category with the highest exposure, leading to overestimation of cumulative exposure.

### B.5.1.3. Simonato et al. (1991)

This study has the largest cohort and the most liver cancer deaths (24). Unfortunately, the exposure information may not be as accurate as in the other two studies discussed above, since it was collected from many different workplaces in several different countries, and since the original reporting of the exposure levels was relatively crude (ranges of <50, 50-499, and  $\geq 500$  ppm). As in the Fox and Collier study, the classification was based on the “highest level to which the workers were potentially exposed.” Thus, as with the previous studies, the estimates of risk from this cohort are probably underestimates of the true risk.

Another problem with the reporting of the results in this study is that the durations of exposure are not cross-classified according to exposure level as was done in the Fox and Collier report. In fact, there is very little information about duration of exposure that would allow

**Table B-7. Risk estimates for angiosarcoma based on epidemiological studies**

<b>Study</b>	<b>Risk based on dose metric RISK (95% UCL RISK/1,000/ppm)</b>
Fox and Collier (1977)	0.71 - 4.22
Jones et al. (1988)	0.97 - 3.60
Simonato et al. (1991)	0.40 - 0.79

estimation of an average value for the entire cohort, let alone the exposure groups. (Note that one cannot use the cumulative exposure groupings, as discussed above, because the exposure level must be separated from exposure duration.) The information in Simonato et al. (1991) Table 2 (person-years of observation by duration of employment) was used to estimate an average duration under the following assumption: if the follow-up time does not depend on the duration of employment, then the differences in the person-years of follow-up is due to the numbers of individuals in each duration category. The weighted average (trying different averages for the  $\geq 20$  year group) gives an estimate of 9 years of employment. This duration was used with model-predicted daily dose metrics for average exposure level estimates of 25, 158, and 600 ppm. The cumulative internal doses were input into the relative risk model with the following observed and expected liver cancer deaths reported by the study authors:

<u>Cumulative Dose</u>	<u>Obs.</u>	<u>Exp.</u>
Low	4	2.52
Medium	7	1.86
High	12	2.12

The resulting risk estimates for each pharmacokinetic dose metric are shown in Table B-7. Again, the lower risk estimates were calculated using the value of  $P_0$  derived in the Simonato et al. (1991) study, while the higher risk estimates were calculated using an estimate of the lifetime liver cancer mortality rate in the U.S. population (Chen and Blancato, 1989).

The comparison in Table B-7 of the analyses of the three sets of data gives some indication of the consistency of the human results, even before the comparison with the animal predictions. It is encouraging that the lifetime risk of liver cancer per  $\mu\text{g}/\text{m}^3$  VC exposure estimated from the three studies only ranges over about one order of magnitude: from 0.1 to  $1.7 \times 10^{-6}$  per  $\mu\text{g}/\text{m}^3$ . Moreover, these estimates are in remarkable agreement with the estimates based on animal data shown in Table B-6. However, any confidence produced by this agreement should be tempered by the likelihood, discussed above, that misclassification of exposure in the human studies may somewhat underestimate the true risk at lower doses. Nevertheless, the agreement of

the pharmacokinetic animal-based risk estimates with the pharmacokinetic human-based risk estimates provides strong support for the assumption used in this study: that cross-species scaling of lifetime cancer risk can be performed on a direct basis of lifetime average daily dose (without applying a body surface area adjustment) when the risks are based on biologically appropriate dose metrics calculated with a validated PBPK model.

Based on a closer consideration of the results, a best estimate of the risk based on the human data can be calculated. The Simonato et al. (1991) study was excluded from this consideration because of the considerable uncertainty regarding exposure durations. Between the remaining two studies, the risk values from Jones et al. (1988) were chosen, since this study is an update of the Fox and Collier (1977) study. Finally, the higher of the two risk values calculated for the Jones et al. (1988) study was chosen, reflecting the underestimation of risk due to classification of workers by the job category with the highest exposure. Based on these factors, a best estimate of risk from the human studies is  $3.6 \times 10^{-3}$  per ppm ( $1.4 \times 10^{-6}$  per  $\mu\text{g}/\text{m}^3$ ). This agrees quite closely with the mean of the risk estimates derived from the Maltoni et al. (1981, 1984) rat and mouse inhalation studies.

### **B.5.2. Calculation of Approximate Risk Estimates for Other Tumors**

Although there is no evidence of human correspondence for the other tumors that occur at low doses in animals, it is of interest to attempt to estimate the likely level of risk that might be predicted for those tumors using a pharmacokinetic approach. Of particular interest are the nephroblastomas, which are a relatively rare tumor in the experimental species in which they were observed, and the mammary tumors, which are of concern in human females. Since the PBPK model does not contain kidney or mammary tissue compartments, and since there are not adequate data on the metabolism of VC in these tissues to construct them, a “zero-order approximation” approach was utilized in which the metabolism of VC in the liver was used as a surrogate for in situ metabolism in the other tissues. Thus RISK was calculated for the conditions and doses of the bioassays showing increased incidence of nephroblastoma or mammary tumors (Table B-2). The results of these dose calculations are shown in Table B-8, and the resulting upper-bound risk estimates, using the 1-hit version of the LMS model, are shown in Tables B-9 and B-10. Note that there is as yet no evidence regarding the mechanism underlying the production of either of these tumors, so the use of the LMS model (and the associated assumption of low-dose linearity) may not be justified. Dose metrics for hepatocellular carcinoma are also listed in Table B-9; these risks are similar to those for angiosarcoma.

Given these caveats, it is interesting to observe that the range of risk estimates based on the incidence of nephroblastomas ( $0.04 \times 10^{-6}$  to  $1.4 \times 10^{-6}$  per  $\mu\text{g}/\text{m}^3$ ) is very similar to that obtained for angiosarcomas. As with angiosarcoma, there was no evidence from the goodness of fit tests that any of the dose metrics provided a better fit to the data. Risk estimates based on the mammary tumors are less consistent, ranging from  $0.1 \times 10^{-6}$  to  $100 \times 10^{-6}$  per  $\mu\text{g}/\text{m}^3$ . Given the extremely high variability of the background incidence for mammary tumors in the experimental animals, as well as the highly nonlinear dose-response (for most of the studies the dose-response in the exposed groups is either flat or decreasing) it does not seem reasonable to perform a

**Table B-8. Dose metric values for other tumors**

Reference	Route	Species	Duration	Dose	Incidence		Daily dose metrics	Lifetime average delivered dose
					Mamm. <sup>a</sup>	Neph. <sup>b</sup>	RISK	RISK
Lee et al., 1977, 1978	Inhalation	Albino CD-1 mice (F)	6 hr/d, 5 d/wk for 52 wk	0 ppm	0/36			
				50 ppm	9/34		235.368	168.12
				250 ppm	3/34		1,008.690	720.49
				1,000 ppm	13/36		1,524.920	1,089.23
Drew et al., 1983	Inhalation	Fischer-344 rats (F)	6 hr/d, 5 d/wk for 104 wk	0 ppm	29/112			
				100 ppm	31/55		274.462	196.04
		Golden Syrian hamsters (F)	6 hr/d, 5 d/wk for 78 wk	0 ppm	0/143			
				200 ppm	47/102		753.523	538.23
		B6C3F1 mice (F)	6 hr/d, 5 d/wk for 52 wk	0 ppm	3/69			
				50 ppm	37/90		242.897	173.50
		CD-1 Swiss mice (F)	6 hr/d, 5 d/wk for 78 wk	0 ppm	2/71			
				50 ppm	22/45		235.368	168.12
Radike et al., 1981	Inhalation	Sprague-Dawley rats (M)	4 hr/d, 5 d/wk for 52 wk	0 ppm				
				600 ppm			617.249	440.89
Maltoni et al., 1981, 1984 (BT1)	Inhalation	Sprague-Dawley rats (M)	4 hr/d, 5 d/wk for 52 of 135 wk	0 ppm	2/29	0/29		
				50 ppm	1/30	0/30	117.990	32.46
				250 ppm	0/29	1/29	473.425	130.25
				500 ppm	0/30	2/30	593.931	163.41
				2,500 ppm	0/30	5/30	803.194	220.98
				6,000 ppm	0/29	4/29	911.248	250.71
				10,000 ppm	1/30	3/30	966.074	265.80
Maltoni et al., 1981, 1984 (BT1) (continued)	Inhalation	Sprague-Dawley rats (F)	4 hr/d, 5 d/wk for 52 of 135 wk	0 ppm	12/29	0/29		
				50 ppm	11/30	1/30	113.653	31.27
				250 ppm	7/30	4/30	375.989	103.45
				500 ppm	5/30	4/30	425.029	116.94
				2,500 ppm	5/30	1/30	488.374	134.37
				6,000 ppm	6/30	1/30	522.359	143.72
				10,000 ppm	7/30	2/30	542.339	149.21

**Table B-8. Dose metric values for other tumors (continued)**

Reference	Route	Species	Duration	Dose	Incidence		Daily dose metrics	Lifetime average delivered dose
					Mamm. <sup>a</sup>	Neph. <sup>b</sup>	RISK	RISK
Maltoni et al., 1981, 1984 (BT2)	Inhalation	Sprague-Dawley rats (M)	4 hr/d, 5 d/wk for 52 of 143 wk	0 ppm	1/85	0/85		
				100 ppm	0/60	8/60	229.851	59.70
				150 ppm	1/59	8/59	330.722	85.90
				200 ppm	3/60	5/60	413.443	107.39
		Sprague-Dawley rats (F)		0 ppm	20/100	0/100		
				100 ppm	20/60	2/60	215.406	55.95
				150 ppm	12/60	3/60	295.167	76.67
				200 ppm	20/60	2/60	346.510	90.00
Maltoni et al., 1981, 1984 (BT4)	Inhalation	Swiss mice (M)	4 hr/d, 5 d/wk for 30 of 81 wk	0 ppm	0/80			
				50 ppm	0/30		161.924	42.84
				250 ppm	0/30		775.615	205.19
				500 ppm	1/30		1,245.220	329.42
				2,500 ppm	0/29		1,434.800	379.58
				6,000 ppm	0/30		1,479.270	391.34
				10,000 ppm	0/26		1,505.580	398.30
Maltoni et al., 1981, 1984 (BT4) (continued)	Inhalation	Swiss mice (F)	4 hr/d, 5 d/wk for 30 of 81 wk	0 ppm	1/70			
				50 ppm	12/30		156.683	41.45
				250 ppm	13/30		672.996	178.04
				500 ppm	10/30		887.322	234.74
				2,500 ppm	9/30		1,198.110	316.96
				6,000 ppm	9/30		1,341.100	354.79
				10,000 ppm	14/30		1,405.300	371.77

**Table B-8. Dose metric values for other tumors (continued)**

Reference	Route	Species	Duration	Dose	Incidence		Daily dose metrics	Lifetime average delivered dose
					Mamm. <sup>a</sup>	Neph. <sup>b</sup>	RISK	RISK
Maltoni et al., 1981, 1984 (BT3)	Inhalation	Sprague-Dawley rats (M)	4 hr/d, 5 d/wk for 17 wk	0 ppm	1/108	0/108		
				50 ppm	0/28	1/28	117.990	84.28
				250 ppm	0/30	3/30	473.425	338.16
				500 ppm	0/30	0/30	593.931	424.24
				2,500 ppm	3/30	2/30	803.194	573.71
				6,000 ppm	0/30	0/30	911.248	650.89
				10,000 ppm	1/28	0/28	966.074	690.05
		Sprague-Dawley rats (F)		0 ppm	14/82	0/82		
				50 ppm	11/30	2/30	113.653	81.18
				250 ppm	5/29	3/29	375.989	268.56
				500 ppm	12/30	0/30	425.029	303.59
				2,500 ppm	12/30	0/30	488.374	348.84
				6,000 ppm	4/30	1/30	522.359	373.11
				10,000 ppm	6/30	1/30	542.339	387.39
Maltoni et al., 1981, 1984 (BT9)	Inhalation	Sprague-Dawley Rats (M)	4 hr/d, 5 d/wk for 52 of 142 wks	0 ppm	2/48	0/48		
				50 ppm	14/144	0/144	117.990	30.86
Maltoni et al., 1981, 1984 (BT9) (continued)	Inhalation	Sprague-Dawley rats (F)	4 hr/d, 5 d/wk for 52 of 142 wk	0 ppm	27/50	0/50		
				50 ppm	117/150	1/150	113.653	29.73
Maltoni et al., 1981, 1984 (BT15)	Inhalation	Sprague-Dawley rats (M)	4 hr/d, 5 d/wk for 52 of 147 wk	0 ppm	8/60	0/60		
				1 ppm	8/58	0/58	2.398	0.61
				5 ppm	10/59	0/59	11.985	3.03
				10 ppm	6/59	0/59	23.933	6.05
				25 ppm	11/60	1/60	59.552	15.05
		Sprague-Dawley rats (F)		0 ppm	34/60	0/60		
				1 ppm	46/60	0/60	2.343	0.59
				5 ppm	57/60	0/60	11.698	2.96
				10 ppm	52/60	0/60	23.332	5.90
				25 ppm	53/60	0/60	57.838	14.61

**Table B-8. Dose metric values for other tumors (continued)**

Reference	Route	Species	Duration	Dose	Incidence		Daily dose metrics	Lifetime average delivered dose
					Mamm. <sup>a</sup>	Neph. <sup>b</sup>	RISK	RISK
Maltoni et al., 1981, 1984 (BT10)	Inhalation	Sprague-Dawley rats (M)		Group VII: Control	11/107	0/107		
			4 hr/d, 5 d/wk for 5 of 154 wk	Group I: 10,000 ppm	3/59	0/59	966.074	22.40
				Group II: 6,000 ppm	3/60	1/60	911.248	21.13
			1 hr/d, 4 d/wk for 25 of 154 wk	Group III: 10,000 ppm	2/59	0/59	356.811	33.10
				Group IV: 6,000 ppm	4/59	0/59	319.490	29.64
			4 hr/d, 1 d/wk for 25 of 154 wks	Group V: 10,000 ppm	9/60	0/60	966.074	22.40
Group VI: 6,000 ppm	6/60	1/60		911.248	21.13			
Maltoni et al., 1981, 1984 (BT10) (continued)	Inhalation	Sprague-Dawley rats (F)		Group VII: Control	76/120	0/120		
			4 hr/d, 5 d/wk for 5 of 154 wk	Group I: 10,000 ppm	36/59	0/59	542.339	12.58
				Group II: 6,000 ppm	37/60	1/60	522.359	12.11
			1 hr/d, 4 d/wk for 25 of 154 wk	Group III: 10,000 ppm	42/60	0/60	222.071	20.60
				Group IV: 6,000 ppm	40/60	0/59	202.515	18.79
			4 hr/d, 1 d/wk for 25 of 154 wk	Group V: 10,000 ppm	45/59	1/59	542.339	12.58
Group VI: 6,000 ppm	46/60	0/60		522.359	12.11			
Feron et al., 1981	Oral-diet	Wistar rats (M)	135 weeks	0 mg/kg/day				
				1.7 mg/kg/day			37.561	
				5 mg/kg/day			85.345	
				14.1 mg/kg/day			143.370	
		Wistar rats (F)	144 weeks	0 mg/kg/day				
				1.7 mg/kg/day			34.928	
				5 mg/kg/day			71.008	
				14.1 mg/kg/day			109.035	

**Table B-8. Dose metric values for other tumors (continued)**

Reference	Route	Species	Duration	Dose	Incidence		Daily dose metrics	Lifetime average delivered dose
					Mamm. <sup>a</sup>	Neph. <sup>b</sup>	RISK	RISK
Til et al., 1983	Oral-diet	Wistar rats (M)	149 weeks	0 mg/kg/day	5/100			
				0.014 mg/kg/day	8/99		0.326	0.326
				0.13 mg/kg/day	3/99		3.026	3.026
				1.3 mg/kg/day	0/49		30.2	30.2
		Wistar rats (F)		0 mg/kg/day	41/98			
				0.014 mg/kg/day	21/100		0.318	0.318
				0.13 mg/kg/day	28/96		2.96	2.96
				1.3 mg/kg/day	21/48		29.5	29.5

<sup>a</sup>Mammary gland carcinoma.

<sup>b</sup>Nephroblastoma.



**Table B-9. Human inhalation risk estimates based on the incidence of hepatocellular carcinoma or nephroblastoma in oral and inhalation animal assays and various dose metrics**

	<b>Risk based on dose metric RISK (95% UCL Risk/1,000/ppm)<sup>a</sup></b>	<b>P</b>	<b>Fit</b>
<b>Hepatocellular carcinoma:</b>			
Feron et al. (1981) - Diet			
Male rats	0.71	0.45	Good
Female rats	3.95	0.1	Poor
Til et al. (1983) - Diet			
Male rats	1.86	0.7	Good
Female rats	2.22	0.6	Good
<b>Nephroblastoma:</b>			
Maltoni et al. (1981, 1984) BT1-Inhalation			
Male mouse	1.2	0.7	Good
Female mouse	1.63	0.2	OK
Maltoni et al. (1981, 1984) BT2-Inhalation			
Male rats	3.34	0.1	OK
Female rats	1.52	0.8	Good
Maltoni et al. (1981, 1984) BT3-Inhalation (17 wks)			
Male rats	0.22	0.01	Reject
Female rats	0.37	0.02	Reject

<sup>a</sup>Risks were calculated using the 1-hit version of the LMS model.

**Table B-10. Human inhalation risk estimates based on total mammary tumor incidence in oral and inhalation animal assays and various dose metrics**

	Risk Based on Dose Metric RISK (95% UCL Risk/1,000/ppm) <sup>a</sup>	P	Fit
	RISK		
Lee et al. (1977, 1978) Female mice	0.78	0.0003	Reject
Maltoni et al. (1981, 1984) BT2-Inhalation Male rats Female rats	0.79 4.74	0.3 0.1	OK Poor
Maltoni et al. (1981, 1984) BT4-Inhalation Female mice	3.00	0.002	Reject
Maltoni et al. (1981, 1984) BT3-Inhalation (17 weeks) Female rats	0.95	0.01	Reject
Maltoni et al. (1981, 1984) BT15-Inhalation Male rats Female rats	17.4 251	0.7 10 <sup>-11</sup>	Good Reject
Til et al. (1983) - Diet Female rats	7.53	0.005	Reject

<sup>a</sup>Risks were calculated using the 1-hit version of the LMS model.

quantitative risk estimate based on this tumor outcome. Nevertheless, it is important to note that human females also demonstrate a background incidence of mammary tumors, and that the epidemiological cohorts did not include females. Therefore, it seems reasonable that the evidence of increased mammary tumor incidence from VC should be considered at least qualitatively during risk management decisions regarding potential human VC exposure.

## **B.6. PHARMACOKINETIC SENSITIVITY/UNCERTAINTY ANALYSIS**

Table B-11 shows the normalized analytical sensitivities for the PBPK model described above. The normalized analytical sensitivity coefficient represents the fractional change in output associated with a fractional change in the input parameter. For example, if a 1% change in the input parameter results in a 2% change in the output, the sensitivity coefficient would be 2.0. In Table B-11, the outputs are the dose metrics used in the analysis of angiosarcoma risk. The parameters in the table are defined in Tables B-3 and B-4. Sensitivity coefficients of less than 0.01 in absolute value were omitted from the table for clarity, and coefficients greater than 0.2 in absolute value are outlined for emphasis. None of the parameters display sensitivities markedly greater than 1.0, indicating that there is no amplification of error from the inputs to the outputs. This is, of course, a desirable trait in a model to be used for risk assessment.

It can be seen that of the 24 parameters in the VC model, 10 have essentially no impact on risk predictions based on any of the dose metrics, and only 8 have a significant impact on predictions based on RISK: the body weight (BW), alveolar ventilation (QPC), cardiac output (QCC), liver blood flow (QLC) and volume (VLC), blood/air partition coefficient (PB), the capacity (VMAX1C) and affinity (KM1) for metabolism by CYP2E1, and in the case of oral gavage, the oral uptake rate (KA). As discussed in the description of the PBPK model, all of these parameters could be reasonably well characterized from experimental data. However, the sensitivity of the risk predictions to the human values of these parameters implies that the risk from exposure to VC could vary considerably from individual to individual, depending on specific physiology, level of activity, and metabolic capability.

The other dose metrics, RISKM and RISKG (data not shown), are also sensitive to a number of the parameters in the model for the subsequent metabolism of the reactive metabolites, as well as for the GSH submodel. Since these parameters could only be identified from data in rats, their values in other species are uncertain. Given the sensitivity of RISKM and RISKG to these less certain parameters, and the general similarity of risks based on these two metrics to those based on the RISK metric, the RISK metric would seem to be preferable for quantitative risk assessment. Risk estimates reported in the main body of this document were calculated using the RISK metric.

**Table B-11. Normalized parameter sensitivity in the vinyl chloride PBPK model**

Dose metric	Rat inhalation (50 ppm - 4 hr)		Human inhalation (1 ppm - continuous)		Human drinking water (1 ppm)
	RISK	AMET	RISK	AMET	RISK
Parameter					
BW	-0.26	-0.50	-0.22	-0.25	— <sup>a</sup>
QPC	0.32	0.29	0.11	0.13	—
QCC	0.65	0.59	0.44	0.44	-0.35
QFC	—	—	—	—	—
QLC	0.64	0.59	0.44	0.45	-0.35
VFC	—	—	—	—	—
VLC	-0.84	—	-0.66	—	-0.69
PB	0.73	0.67	0.88	0.86	—
PF	—	—	—	—	—
PS	—	—	—	—	—
PR	—	—	—	—	—
PL	—	—	—	—	—
VMAX1C	0.11	0.10	0.44	0.44	0.43
KM1	-0.10	—	-0.44	-0.44	-0.43
VMAX2C	—	—	—	—	—
KM2	—	—	—	—	—
KA	—	—	—	—	—
KCO2C	—	—	—	—	—
KGSMC	—	—	—	—	—
KFEEC	—	—	—	—	—
GSO	—	—	—	—	—
KBC	—	—	—	—	—
KS	—	—	—	—	—
KOC	—	—	—	—	—

<sup>a</sup>Sensitivity coefficient < 0.01 in absolute value.

### **B.6.1. Monte Carlo Uncertainty/Variability Analysis**

The sensitivity analysis described above does not consider the potential interactions between parameters; the parameters are tested individually. Also, sensitivity analysis does not adequately reflect the uncertainty associated with each parameter. The fact that the output is highly sensitive to a particular parameter is not important if the parameter is known exactly. To estimate the combined impact of uncertainty regarding the values of all the parameters, a Monte Carlo analysis can be performed. In a Monte Carlo analysis, the distributions of possible values for each of the input parameters are estimated. The Monte Carlo algorithm then randomly selects a value for each parameter from its distribution and runs the model. The random selection of parameter values and running of the model is repeated a large number of times (typically hundreds to thousands) until the distribution of the output has been characterized.

To assess the impact of parameter uncertainty on risk predictions, a dose-response model must be selected. In this case the 1-hit version of the linearized multistage model was used, for the reasons discussed earlier. The actual analysis was performed with the software package PBPK\_SIM (KS Crump Group, ICF Kaiser International, Ruston, LA), which was developed for the Air Force specifically to perform such a Monte Carlo analysis on PBPK models. The PBPK\_SIM program randomly selects a set of parameter values from the distributions for the bioassay animal and runs the PBPK model to obtain dose metric values for each of the bioassay dose groups. It then selects a set of parameter values from the distributions for the human and runs the PBPK model to obtain a dose metric value for a specified human exposure scenario. Finally, it runs the linearized multistage model (or other specified risk model) with the animal and human dose metric values to obtain the human risk estimate. This entire process is repeated a specified number of times until the desired distribution of risks has been obtained.

Tables B-3 and B-4 list the means (preferred values) and coefficients of variation (CV) used in a Monte Carlo uncertainty analysis of the TCE/TCA model. Truncated normal distributions were used for all parameters except the kinetic parameters, which were assumed to be lognormally distributed. The CVs for the physiological parameters were estimated from data on the variability of published values (U.S. EPA, 1988; Stan Lindstedt, 1992, personal communication), while the CVs for the partition coefficients were based on repeated determinations for two other chemicals, perchloroethylene (Gearhart et al., 1993) and chloropentafluorobenzene (Clewell and Jarnot, 1994). The CVs for the metabolic and kinetic constants were estimated from a comparison of reported values in the literature and by exercising the model against the various data sets to determine the identifiability of the parameters which were estimated from pharmacokinetic data.

The results of the Monte Carlo analysis are shown in Table B-12, which lists the estimated risks associated with lifetime exposure to 1 ppm VC in air or 1 mg/L VC in drinking water. In all cases, the risk estimates represent the 95% UCL for risk, based on the 1-hit version of the LMS model. However, in order to characterize the impact of uncertainty in the pharmacokinetic parameters on the risk estimates, both the mean and the upper 95th percentile of

**Table B-12. Mean and 95<sup>th</sup> percentile UCL RISK/1000 for angiosarcoma based on the pharmacokinetic dose metric<sup>a</sup>**

Animal route	Sex/species	1 ppm inhalation			1 mg/L drinking water		
		Mean/ UCL	P	95th/ UCL	Mean/ UCL	P	95th/ UCL
Inhalation	Male mouse	1.89	0.002	3.38	0.67	0.002	1.18
	Female mouse	3.89	0.25	6.95	1.39	0.25	2.33
Inhalation	Male rat	6.80	0.20	14.31	2.45	0.20	5.60
	Female rat	1.90	0.44	3.81	0.67	0.44	1.37
Oil gavage	Male rat	9.45	0.57	17.22	3.36	0.57	5.72
	Female rat	16.35	0.11	29.73	5.83	0.11	10.54
Diet	Male rat	3.26	0.05	5.26	1.14	0.05	1.64
	Female rat	1.15	0.43	1.87	0.41	0.43	0.60

<sup>a</sup>Dose metric = lifetime-average total amount metabolized per day, divided by the volume of liver.

the distribution of UCL risk estimates are shown. Thus the mean value represents the best estimate of the pharmacokinetically based upper-bound risk for VC exposure, and the 95th percentile provides a reasonable value for the “highest probable” pharmacokinetic risk estimate, considering both pharmacokinetic uncertainty and uncertainty regarding the low-dose extrapolation. The small differences between the best estimates in Table B-12 and those in Table B-6 result from the way in which they were calculated. While the values in Table B-6 are the risk estimates using the mean values for the parameters, the values in Table B-12 are the mean risk estimates based on the distribution of risk estimates calculated in the Monte Carlo analysis. Giving priority to the animal studies most closely approximating the human route of exposure, the best conservative estimate of the carcinogenic risk of angiosarcoma from lifetime exposure to 1 ppm VC in air is  $2.6 \times 10^{-3}$ , or  $1.01 \times 10^{-6}$  per  $\mu\text{g}/\text{m}^3$ , based on inhalation studies in male rats (Maltoni et al., 1981, 1984). This value is consistent with the range of estimates from epidemiological studies of  $0.2 \times 10^{-6}$  to  $1.7 \times 10^{-6}$  risk per  $\mu\text{g}/\text{m}^3$  VC, but is roughly a factor of 84 below the currently published inhalation unit risk of  $8.4 \times 10^{-5}$  per  $\mu\text{g}/\text{m}^3$ . Similarly, the best conservative estimate of the carcinogenic risk of angiosarcoma alone from lifetime exposure to 1 mg/L VC in drinking water is  $1.1 \times 10^{-3}$  (mg/L)<sup>-1</sup>, or  $1.1 \times 10^{-6}$  ( $\mu\text{g}/\text{L}$ )<sup>-1</sup>, based on studies with male rats of the dietary administration of VC (Feron et al., 1981). This value is roughly a factor of 50 below the currently published unit risk of  $5.4 \times 10^{-5}$  ( $\mu\text{g}/\text{L}$ )<sup>-1</sup>. The currently published risk estimate, however, is based upon all liver tumors in females. Using the present model and all liver tumors, the risk is estimated to equal  $1.2 \times 10^{-5}$  ( $\mu\text{g}/\text{L}$ )<sup>-1</sup>, a value only 4-5 fold less than the presently published value. As discussed in the Toxicological Review, these values have been derived using only liver angiosarcomas in order to compare with results of other modeling approaches, and do not account for other liver tumors or uncertainties based upon suggestive evidence for induction of tumors at other locations.

## **B.7. DISCUSSION**

Although VC has often been cited as a chemical for which saturable metabolism should be considered in the risk assessment, saturation appears to become important only at very high exposure levels (greater than 250 ppm by inhalation or 25 mg/kg/day orally) compared to the lowest tumorigenic levels, and thus has little impact on the quantitative risk estimates. The important contribution of pharmacokinetic modeling is to provide a more biologically plausible estimate of the effective dose: total production of reactive metabolites at the target tissue. The ratio of this biologically effective dose to the administered dose is not uniform across routes and species. Therefore, any estimate of administered dose is less adequate for performing route-to-route and interspecies extrapolation of risk. The risk estimates obtained for VC using the pharmacokinetic dose metric are lower than those obtained with conventional external dose calculations by a factor of 30 to 50, and appear to be more consistent with human epidemiological data.

In the pharmacokinetic risk calculations presented in this report, no BSA adjustment factor was applied to obtain the human risks. Although this may appear to represent a departure

from previous EPA practice in a risk assessment for VC, this marks the first time a pharmacokinetic dose metric has been used. The dose metric was selected to be consistent with the position stated in the interagency pharmacokinetics group consensus report on cross-species extrapolation of cancer (U.S. EPA, 1992) that "...tissues experiencing equal average concentrations of the carcinogenic moiety over a full lifetime should be presumed to have equal lifetime cancer risk." However, in the only pharmacokinetic risk assessment adopted by the EPA to this date, the pharmacokinetic dose metric used for methylene chloride was also a "virtual concentration" of an as-yet-unidentified reactive metabolite, and its use similarly appeared to be consistent with the EPA position. Nevertheless, in its actual application of the methylene chloride pharmacokinetic model, EPA chose to adjust the pharmacokinetic dose metric by a BSA scaling factor to consider potential species differences in pharmacodynamics (U.S. EPA, 1987). It is not clear that there will ever be a definitive scientific basis for establishing the correct interspecies extrapolation of genotoxic carcinogenicity. At this time it remains more of a science policy issue.

The risk assessment performed in this study has focused on cancer risk from a continuous lifetime exposure, or at least an exposure over a large fraction of lifetime. Although there are certainly many uncertainties and unresolved issues regarding cross-species extrapolation of lifetime risks, there are even greater uncertainties regarding the extrapolation of partial-lifetime exposures. In particular, studies performed with VC make it evident that extrapolation of partial lifetime exposure is not straightforward with this chemical. For example, in the comparative studies of partial lifetime exposure of rats to VC discussed earlier (Drew et al., 1983), whereas exposure from 0 to 6 months resulted in a similar tumor incidence to exposure from 6 to 12 months of life, exposure from 0 to 12 months produced a significantly different incidence than would be expected from the sum of the incidences for the two subintervals. For angiosarcomas, on the one hand, exposure to VC from 0 to 6 months and from 6 to 12 months resulted in incidences of 5.3% and 3.8%, respectively, while exposure from 0 to 12 months resulted in a much higher incidence of 21.4%. For hepatocellular carcinomas, on the other hand, exposure to VC from 0 to 6 months and from 6 to 12 months resulted in incidences of 4.0% and 11.5%, respectively, while exposure from 0 to 12 months resulted in an incidence of only 7.1%. Thus this comparative bioassay does not provide support for a simple relationship of the observed incidence to the fraction of lifetime of the exposure. As discussed earlier, it seems reasonable to assume that newborns, with their higher rate of cell proliferation, should be at greater risk from genotoxic carcinogens, and some studies with VC support this assumption (Maltoni et al., 1981; Laib et al., 1989; Fedtke et al., 1990), although other well-conducted studies with VC do not (Drew et al., 1983). The issue of sensitive populations has never been seriously dealt with in quantitative carcinogenic risk assessment, but it would seem to be an appropriate consideration during risk management for specific potential exposures.



## REFERENCES

Andersen, M; Clewell, H; Gargas, M; et al. (1987a) Physiologically based pharmacokinetics and the risk assessment process for methylene chloride. *Toxicol Appl Pharmacol* 87:185-205.

Andersen, ME; Gargas, ML; Clewell, HJ; et al. (1987b) Quantitative evaluation of the metabolic interactions between trichloroethylene and 1,1-dichloroethylene by gas uptake methods. *Toxicol Appl Pharmacol* 89:149-157.

Baretta, ED; Stewart, RD; Mutchler, JE. (1969) Monitoring exposures to vinyl chloride vapor: breath analysis and continuous air sampling. *Am Indust Hygiene Assoc J* 30:537-544.

Barton, HA; Creech, JA; Godin, CS; et al. (1995) Chloroethylene mixtures: pharmacokinetic modeling and *in vitro* metabolism of vinyl chloride, trichloroethylene, and trans-1,2-dichloroethylene in the rat. *Toxicol Appl Pharmacol* 130(2):237-247.

Bolt, HM; Laib, RJ; Kappus, H; et al. (1977) Pharmacokinetics of vinyl chloride in the rat. *Toxicology* 7:179-188.

Buchter, A; Bolt, HM; Filser, JG; et al. (1978) Pharmakokinetik und karzinogenese von vinylchlorid. *Arbeitsmedizinische Risikobeurteilung. Verhandlungen der Deutschen Gesellschaft fuer Arbeitsmedizin*, Vol. 18, Gentner Verlag, Stuttgart, pp. 111-124.

Buchter, A; Filser, JG; Peter, H; et al. (1980) Pharmacokinetics of vinyl chloride in the Rhesus monkey. *Toxicol Lett* 6:33-36.

Bull, RJ; Brown, JM; Meierhenry, EA; et al. (1986) Enhancement of the hepatotoxicity of chloroform in B6C3F1 mice by corn oil: implications for chloroform carcinogenesis. *Environ Health Perspect* 69:49-58.

Chen, CW; Blancato, JN. (1989) Incorporation of biological information in cancer risk assessment: Example - vinyl chloride. *Cell Biol Toxicol* 5:417-444.

Clement Associates. (1987) Investigation of cancer risk assessment methods. Final report. Vol. 1: Introduction and Epidemiology. Prepared for the U.S. Environmental Protection Agency, the Department of Defense, and the Electric Power Research Institute.

Clement International. (1990) Development and Validation of Methods for Applying Pharmacokinetic Data in Risk Assessment. Final Report. Volume V: Vinyl Chloride. AAMRL-TR-90-072. Prepared for the Department of the Air Force, Armstrong Aerospace Medical Research Laboratory, Wright-Patterson Air Force Base, Ohio.

Clewell, HJ; Jarnot, BM. (1994) Incorporation of pharmacokinetics in non-carcinogenic risk assessment: Example with chloropentafluorobenzene. *Risk Anal* 14:265-276.

Clewell, HJ; Gentry, PR; Gearhart, JM; et al. (1995a) The development and validation of a physiologically based pharmacokinetic model for vinyl chloride and its application in a carcinogenic risk assessment for vinyl chloride. ICF Kaiser report prepared for EPA/OHEA and OSHA/DHSP.

DeAngelo, AB; Daniel, FB; McMillan, L; et al. (1989) Species and strain sensitivity to the induction of peroxisome proliferation by chloroacetic acids. *Toxicol Appl Pharmacol* 101:285-298.

Drew, RT; Boorman, GA; Haseman, JK; et al. (1983) The effect of age and exposure duration on cancer induction by a known carcinogen in rats, mice, and hamsters. *Toxicol Appl Pharmacol* 68:120-130.

D'Souza, RW; Andersen, ME. (1988) Physiologically based pharmacokinetic model for vinylidene chloride. *Toxicol Appl Pharmacol* 95:230-240.

Fedtke, N; Boucheron, JA; Walker, VE; et al. (1990) Vinyl chloride-induced DNA adducts. II: Formation and persistence of 7-(2'-oxoethyl)guanine and N<sup>2</sup>,3-ethenoguanine in rat tissue DNA. *Carcinogenesis* 11:1287-1292.

Feron, VJ; Hendriksen, CFM; Speek, AJ; et al. (1981) Lifespan oral toxicity study of vinyl chloride in rats. *Food Cosmetol Toxicol* 19:317-333.

Fox, AJ; Collier, PF. (1977) Mortality experience of workers exposure to vinyl chloride monomer in the manufacture of polyvinyl chloride in Great Britain. *Br J Ind Med* 34:1-10.

Gargas, ML; Burgess, RJ; Voisard, DE; et al. (1989) Partition coefficients of low-molecular-weight volatile chemicals in various liquids and tissues. *Toxicol Appl Pharmacol* 98:87-99.

Gargas, ML; Clewell, HJ, III; Andersen, ME. (1990) Gas uptake techniques and the rates of metabolism of chloromethanes, chloroethanes, and chloroethylenes in the rat. *Inhal. Toxicol.* 2:295-319.

Gearhart, JM; Mahle, DA; Greene, RJ; et al. (1993) Variability of physiologically based pharmacokinetic (PBPK) model parameters and their effect on PBPK model predictions in a risk assessment for perchloroethylene (PCE). *Toxicol Lett* 68:131-144.

Gehring, PJ; Watanabe, PG; Park, CN. (1978) Resolution of dose-response toxicity data for chemicals requiring metabolic activation: example -- vinyl chloride. *Toxicol Appl Pharmacol* 44:581-591.

Guengerich, FP; Mason, PS; Stott, WT; et al. (1981) Roles of 2-haloethylene oxides and 2-haloacetaldehydes derived from vinyl bromide and vinyl chloride in irreversible binding to protein and DNA. *Cancer Res* 41:4391-4398.

Jedrychowski, RA; Sokal, JA; Chmielnicka, J. (1985) Comparison of the impact of continuous and intermittent exposure to vinyl chloride, including phenobarbital effects. *J Hyg Epidemiol Microbiol Immunol* 28:111-120.

Jones, RW; Smith, DM; Thomas, PG. (1988) A mortality study of vinyl chloride monomer workers employed in the United Kingdom in 1940–1974. *Scand J Work Environ Health* 14:153-160.

Laib, RJ; Bolt, HM. (1980) Trans-membrane alkylation: a new method for studying irreversible binding of reactive metabolites to nucleic acids. *Biochem Pharmacol* 29:449-452.

Laib, RJ; Bolt, HM; Cartier, R; et al. (1989) Increased alkylation of liver DNA and cell turnover in young versus old rats exposed to vinyl chloride correlates with cancer susceptibility. *Toxicol Lett* 45:231-239.

Lindstedt, S. (1992) Personal Communication -- Draft report to the ILSI RSI Physiological Parameters Working Group.

Maltoni, C; Lefemine, G; Ciliberti, A; et al. (1981) Carcinogenicity bioassay of vinyl chloride monomer: a model of risk assessment on an experimental basis. *Environ Health Perspect* 41:3-29.

Newberne, PM; Weigert, J; Kula, N. (1979) Effects of dietary fat on hepatic mixed function oxidases and hepatocellular carcinoma induced by aflatoxin B<sub>1</sub> in rats. *Cancer Res* 39:3986-3991.

Ottenwalder, H; Bolt, HM. (1980) Metabolic activation of vinyl chloride and vinyl bromide by isolated hepatocytes and hepatic sinusoidal cells. *J Environ Pathol Toxicol* 4:411-417.

Reitz, RH; Mendrala, AL; Guengerich, FP. (1989) In vitro metabolism of methylene chloride in human and animal tissues: Use in physiologically-based pharmacokinetic models. *Toxicol Appl Pharmacol* 97:230-246.

Reitz, RH; Gargas, ML; Anderson, ME; et al. (1996) Predicting cancer risk from vinyl chloride exposure with a physiologically based pharmacokinetic model. *Toxicol Appl Pharmacol* 136:1-16.

Sabadie, N; Malaveille, C; Carmus, A-M; et al. (1980) Comparison of the hydroxylation of benzo(a)pyrene with the metabolism of vinyl chloride, *N*-nitrosomorpholine, and *N*-nitroso-*N'*-methylpiperazine to mutagens by human and rat liver microsomal fractions. *Cancer Res* 40(1):119-126.

Simonato, L; L'Abbe, KA; Andersen, A; et al. (1991) A collaborative study of cancer incidence and mortality among vinyl chloride workers. *Scand J Work Environ Health* 17:159-169.

U.S. EPA. (1987) Update to the health assessment document and addendum for dichloromethane (methylene chloride): pharmacokinetics, mechanism of action, and epidemiology. External Review Draft. EPA/600/8-87/030A.

U.S. EPA. (1988) Reference physiological parameters in pharmacokinetic modeling. EPA/600/6-88/004. Office of Health and Environmental Assessment, Washington, DC.

U.S. EPA. (1992) Request for comments on draft report of cross-species scaling factor for cancer risk assessment. *Fed. Reg.* 57:24152.

Watanabe, PG; Gehring, PJ. (1976) Dose-dependent fate of vinyl chloride and its possible relationship to oncogenicity in rats. *Environ Health Perspect* 17:145-152.

Watanabe, PG; Hefner, RE, Jr.; Gehring, PJ. (1976c) Vinyl chloride-induced depression of hepatic non-protein sulfhydryl content and effects on bromosulphthalein (BSP) clearance in rats. *Toxicology* 6:1-8.

Withey, JR. (1976) Pharmacodynamics and uptake of vinyl chloride monomer administered by various routes to rats. *J Toxicol Environ Health* 1(3):381-394.

**APPENDIX C. VINYL CHLORIDE PBPK MODEL CODE  
(ACSL VERSION: VCPBPB.CSL)**

PROGRAM VCPBPB.CSL – Vinyl Chloride Risk Assessment Model

INITIAL

CAT - BODY WEIGHT

CONSTANT BW - 70 Body Weight (kg)  
ENDCAT

CAT - SPECIAL FLOW RATES

CONSTANT QPC - 24 Unscaled Alveolar Vent  
CONSTANT QCC - 16.5 Unscaled Cardiac Output

CAT - FRACTIONAL BLOOD FLOWS TO TISSUES

CONSTANT QLC - 0.24 Flow to Liver as % Cardiac Output  
CONSTANT QFC - 0.05 Flow to Fat as % Cardiac Output  
CONSTANT QSC - 0.19 Flow to Slow as % Cardiac Output  
CONSTANT QRC - 0.52 Flow to Rapid as % Cardiac Output  
ENDCAT

CAT - FRACTIONAL VOLUMES OF TISSUES

CONSTANT VLC - 0.04 Volume Liver as % Body Weight  
CONSTANT VFC - 0.19 Volume Fat as % Body Weight  
CONSTANT VRC - 0.05 Volume Rapid Perfused as % Body Weight  
CONSTANT VSC - 0.63 Volume Slow Perfused as % Body Weight  
ENDCAT

CAT - PARTITION COEFFICIENTS - GARGAS ET AL. (1989)

CONSTANT PL - 0.95 Liver/Blood Partition Coefficient  
CONSTANT PF - 11.9 Fat/Blood Partition Coefficient  
CONSTANT PS - 1.25 Slow/Blood Partition Coefficient  
CONSTANT PR - 0.95 Rapid/Blood Partition Coefficient  
CONSTANT PB - 1.68 Blood/Air Partition Coefficient  
ENDCAT

CAT - KINETIC CONSTANTS

CONSTANT MW - 62.5 Molecular weight (g/mol)  
CONSTANT KA - 3.0 Oral uptake rate (/hr)  
CONSTANT VMAX1C - 4.0 Scaled Vmax for 1<sup>st</sup> Saturated Pathway  
CONSTANT KM1 - 1.0 Km for 1<sup>st</sup> Saturated Pathway  
CONSTANT VMAX2C - 0.0 Scaled Vmax for 2<sup>nd</sup> Saturated Pathway  
CONSTANT KM2 - 10.0 Km for 2<sup>nd</sup> Saturated Pathway  
ENDCAT

CAT - DOSING INFORMATION

CONSTANT	PDOSE - 0.1	Oral dose (mg/kg)
CONSTANT	DRINK - 0.0	Dose (mg/kg/day) in H <sub>2</sub> O
CONSTANT	CONC - 100.0	Inhaled concentration (ppm)
CONSTANT	TCHNG - 6.0	

ENDCAT

CAT - GSH PARAMETERS GROUP 1

CONSTANT	KGSMC - 0.13	Conjugated rate constant with metabolite
CONSTANT	KFEEC - 35.0	Conjugated rate constant with non-GSH
CONSTANT	KCO2C - 1.6	First-order CEO breakdown to CO <sub>2</sub>

ENDCAT

CAT - GSH PARAMETERS GROUP 2

CONSTANT	KOC - 28.5	Zero-order production of GSH
CONSTANT	KBC - 0.12	First-order rate constant for GSH breakdown
CONSTANT	KS - 2000.0	Constant controlling resynthesis
CONSTANT	GSO - 5800.0	Initial GSH concentration
CONSTANT	H2O - 55.0	Moles of H <sub>2</sub> O

ENDCAT

CAT - SIMULATION LENGTH CONTROL

CONSTANT	TSTOP - 24.0
CONSTANT	POINTS - 1.0
CONSTANT	H - 10000.0

ENDCAT

Set initial values

IF (PDOSE.EQ.0.0) KA - 0.0      Parenteral dosing

Scaled parameters

CINT - TSTOP / POINTS

NSTP - CINT\*H + 1

QC - QCC*BW**0.75	Cardiac output
QP - QPC*BW**0.75	Alveolar ventilation
QL - QLC*QC	Liver blood flow
QF - QFC*QC	Fat blood flow
QS - QSC*QC	Slowly perfused tissue blood flow
QR - QRC*QC	Richly perfused tissue blood flow
QC - QL + QF + QS + QR	
VL - VLC*BW	Liver volume
VF - VFC*BW	Fat tissue volume
VS - VSC*BW	Slowly perfused tissue volume
VR - VRC*BW	Richly perfused tissue volume

GSO -  $VLC \cdot BW \cdot GSO$  Initial amount of GSH  
 KGSM -  $KGSMC / BW^{**}0.25$  Reaction with GSH  
 KFEE -  $KFEEC / BW^{**}0.25$  Reaction with other tissues  
 KO -  $KOC \cdot BW^{**}0.75$  Zero-order GSH production  
 KB -  $KBC / BW^{**}0.25$  Normal GSH turnover  
 KCO2 -  $KCO2C / BW^{**}0.25$  Production of CO<sub>2</sub>  
 VMAX1 -  $VMAX1C \cdot BW^{**}0.75$  Maximum rate of metabolism  
 VMAX2 -  $VMAX2C \cdot BW^{**}0.75$  Maximum rate of metabolism  
 VMAX1M -  $VMAX1C \cdot BW^{**}0.75 \cdot 1000.0 / MW$   
 VMAX2M -  $VMAX2C \cdot BW^{**}0.75 \cdot 1000.0 / MW$   
 DOSE -  $PDOSE \cdot BW$   
 KZER -  $DRINK / 24.0 \cdot BW$   
 CIX -  $CONC \cdot MW / 24450.0$

WADDF - 5.0/7.0  
 IF (BW.LT.0.1) THEN  
     LADDF -  $WADDF \cdot (30.0 / 104.0)$  Mice  
 ELSE IF (BW.GT.1.0) THEN  
     LADDF - 1.0 Humans  
 ELSE IF (DRINK.GT.0.0) THEN  
     LADDF - 1.0 Drinking Water  
 ELSE IF (CONC.GT.30.0) THEN  
     LADDF -  $WADDF \cdot (52.0 / 147.0)$  Hi  
 ELSE IF (CONC.GT.0.0) THEN  
     LADDF -  $WADDF \cdot (52.0 / 135.0)$  Low  
 ELSE  
     LADDF -  $WADDF \cdot (52.0 / 136.0)$  Gavage  
 ENDIF  
 END END OF INITIAL

DYNAMIC  
 ALGORITHM IALG - 2

#### DERIVATIVE

Concentration in Arterial Blood (mg/L)  
 (Algebraic Solution for CA after gas exchange)  
 CI -  $CIX \cdot (1.0 - STEP / TCHNG)$   
 CA -  $(QC \cdot CV + QP \cdot CI) / (QC + QP / PB)$   
 AUCB -  $INTEG (CA.0.0)$

Amount Exhaled (mg)  
 CX -  $CA / PB$   
 CALPPM -  $CX \cdot 24450.0 / MW$   
 CXPPM -  $(0.7 \cdot CX + 0.3 \cdot CI) \cdot 24450.0 / MW$   
 RAX -  $QP \cdot CX$

AX - INTEG (RAX.0.0)

Amount in Liver Compartment (mg)

RAL - QL\*(CA-CVL) - RAM + RAO + KZER

AL - INTEG (RAL.0.0)

CVL - AL/(VL\*PL)

CL - AL/VL

AUCL - INTEG (CL, 0.0)

Amounts Metabolized in Liver

RAM - VMAX1\*CVL/(KM1 + CVL) + VMAX2\*CVL/(KM2 + CVL)

AM - INTEG (RAM,0.0)

RISK - AM/VL

RISKT - LADDF\*RISK

AMP - AM\*1000./MW

RAMP - RAM\*1000.0/MW

Amount in Slowly Perfused Tissues (mg)

RAS - QS\* (CA - CVS)

AS - INTEC (..AS,0.0)

CVS - AS/(.....\*PS)

CS - AS/VS

Amount in Rapidly Perfused Tissues (mg)

RAR - QR\*(CA - CVR)

AR - INTEG (RAR,0.0)

CVR - AR/(VR\*PR)

CR - AR/VR

Mixed Venous Blood Concentration (mg/L)

CV - (QF\*CVF + QL\*CVL + QS\*CVS + QR\*CVR)/QC

Amount in Fat Compartment (mg)

RAF - QF\* (CA - CVF)

AF - INTEG (RAF,0.0)

CVF - AF/(VF\*PF)

CF - AF/VF

Total Mass Input from Stomach (mg)

RAO - KA\*MR

AO - DOSE-MR

Amount Remaining in Stomach (mg)

RMR - KA\*MR

MR - DOSE\*EXP(-KA\*T)



Amount of Oxidative Metabolite (uMoles)

RAMM - (VMAX1M\*CVL)/(KM1+CVL) + (VMAX2M\*CVL)/(KM2 + CVL) -  
RACMG - RACMEE - RACO2  
AMM - INTEG (RAMM,0.0)  
CMM - AMM/VL

Glutathione (uMoles)

RAMGSH - KO\*(KS+GSO)/(KS+GSH)-KB\*GSH\*VL-RACMG  
AMGSH - INTEG (RAMGSH,GSO)  
GSH - AMGSH/VL  
GSHP - (AMGSH/GSO)\*100

Amount Metabolite Conjugated with GSH (uMoles)

RACMG - KGSM\*GSH\*CMM\*VL  
ACMG - INTEG (RACMG,0.0)  
RISKG - ACMG/VL  
RISKR - LADDF\*RISKG

Amount Metabolite Conjugated with Other Things (uMoles)

RACMEE - KFEE\*CMM\*VL  
ACMEE - INTEG (RACMEE,0.0)  
RISKM - ACMEE/VL  
RISKN - LADDF\*RISKM

Amount of CO<sub>2</sub> (uMoles)

RAC02 - KCO2\*CMM\*H2O\*VL  
AC02 - INTEG (RACO2,0.)

Total Intake of Vinyl Chloride (mg)

AMET - AM/BW

TERMT (T.GE.TSTOP)

END END OF DERIVATIVE

END END OF DYNAMIC

END END OF PROGRAM

## **APPENDIX D. THE APPLICATION OF A PBPK MODEL FOR VINYL CHLORIDE IN A NONCANCER RISK ASSESSMENT**

This appendix discusses the application of the PBPK model described in Appendix A for noncancer risk assessment. Applications of the PBPK model using both the NOAEL/LOAEL approach and the benchmark dose (BMD) modeling approach are described, and the results of BMD modeling for several endpoints are considered.

### **D.1. SELECTION OF A NONCANCER RISK ASSESSMENT APPROACH**

As discussed in Section 4.4 of the main document, evidence is strong that the carcinogenicity and liver toxicity of VC are related to the production of reactive metabolic intermediates. The most appropriate pharmacokinetic dose metric for a reactive metabolite is the total amount of the metabolite generated divided by the volume of the tissue in which it is produced (Andersen et al., 1987a). It has been demonstrated in the case of VC that binding to liver macromolecules following inhalation exposure of rats correlates well with total metabolism rather than exposure concentration (Watanabe et al., 1978). Therefore, the most reasonable dose metric for liver toxicity would be the total amount of metabolism divided by the volume of the liver. This dose metric, referred to in the PBPK model as RISK, will be used for evaluating the dose response for increased liver/body weight ratio and liver nonneoplastic effects.

In the case of toxicity to the testes, as observed by Bi et al. (1985) and Sokal et al. (1980), the most appropriate dose metric is less certain. However, toxicity from locally generated reactive metabolites is a reasonable mechanism for an organ for which there is evidence of P450 activity, such as the testes. The most appropriate dose metric in this case, analogous to the case of the liver, would be the total amount of metabolism in the testes divided by the volume of the testes. Unfortunately, there is not adequate information on P450 activity for VC in the testes to support this approach; therefore a surrogate must be used. If it is assumed (1) that P450 metabolism in the testes and P450 metabolism in the liver scale across species in the same way (that is, the proportion of metabolism between the testes and liver is constant) and (2) that the relative proportion of body weight associated with the testes is the same across species, then the total amount of metabolism divided by body weight can be used as the surrogate dose metric for testicular toxicity and is designated as AMET in this assessment.

### **D.2. COMPARISON OF NONCANCER RISK ASSESSMENTS FOR VC**

The Clewell model was used to calculate the pharmacokinetic dose metrics for the most informative of the animal studies (Bi et al., 1985; Sokal et al., 1980; Wisniewska-Knypl et al., 1980; Torkelson et al., 1961; Feron et al., 1981; Til et al., 1983, 1991). Because the model calculates delivered dose at the target tissue, an oral study (Til et al., 1983, 1991) could be modeled and converted to exposure concentrations without the need for additional route-to-route extrapolation. Because a high-quality chronic oral study, but no chronic inhalation study, was available, no attempt was made to conduct a route-to-route extrapolation for oral exposure. The studies and calculated dose metrics for the endpoints of interest are shown in Table D-1.

Table D-1. Dose metric values (RISK and AMET) for various vinyl chloride studies

Reference	Route	Species	Exposure duration	Concentration or dose	Human equivalent concentration	Daily dose metrics		Average daily delivered dose	
						RISK	AMET	RISK	AMET
Bi et al. (1984)	Inhalation	Wistar rats (M)	6 hr/d, 6 d/wk	0 mg/m <sup>3</sup>	0 mg/m <sup>3</sup>				
				25.6 mg/m <sup>3</sup>	5.5 mg/m <sup>3</sup>	38	1.52	32.5	1.3
				256 mg/m <sup>3</sup>	55 mg/m <sup>3</sup>	364	14.6	312	12.5
				7670 mg/m <sup>3</sup>	1654 mg/m <sup>3</sup>	1260	50.4	1080	43.2
Sokal et al. (1980)	Inhalation	Wistar rats (M)	5 hr/d, 5 d/wk for 10 months	0 mg/m <sup>3</sup>	0 mg/m <sup>3</sup>				
				128 mg/m <sup>3</sup>	19 mg/m <sup>3</sup>	156	6.24	111	4.46
				1280 mg/m <sup>3</sup>	190 mg/m <sup>3</sup>	779	31.2	556	22.3
				51140 mg/m <sup>3</sup>	7610 mg/m <sup>3</sup>	1300	51.9	927	37.1
Torkelson et al. (1961)	Inhalation	Rats (M)	0.5 hrs/d, 5 d/wk for 6 months	256 mg/m <sup>3</sup>	3.8 mg/m <sup>3</sup>	25	0.99	17.8	0.71
				511 mg/m <sup>3</sup>	7.6 mg/m <sup>3</sup>	43.3	1.73	30.9	1.24
			1 hr/day, 5 d/wk for 6 months	128 mg/m <sup>3</sup>	3.8 mg/m <sup>3</sup>	26.2	1.05	18.7	0.75
				256 mg/m <sup>3</sup>	7.6 mg/m <sup>3</sup>	48.8	1.95	34.8	1.39
				511 mg/m <sup>3</sup>	15.2 mg/m <sup>3</sup>	83	3.32	59.3	2.37
			2 hr/day, 5 d/wk for 6 months	128 mg/m <sup>3</sup>	7.6 mg/m <sup>3</sup>	53.4	2.14	38.1	1.53
				256 mg/m <sup>3</sup>	15.2 mg/m <sup>3</sup>	101	4.03	72	2.88
				511 mg/m <sup>3</sup>	30.4 mg/m <sup>3</sup>	163	6.51	116	4.65

**Table D-1. Dose metric values (RISK and AMET) for various vinyl chloride studies (continued)**

Reference	Route	Species	Exposure duration	Concentration or dose	Human equivalent concentration	Daily dose metrics		Average daily delivered dose	
					Dur Adj × blood PK	RISK	AMET	RISK	AMET
Torkelson et al. (1961) (continued)			4 hr/day, 5d/wk for 6 months	128 mg/m <sup>3</sup>	15.2 mg/m <sup>3</sup>	105	4.19	74.7	2.99
				256 mg/m <sup>3</sup>	30.5 mg/m <sup>3</sup>	197	7.87	141	5.62
				511 mg/m <sup>3</sup>	60.8 mg/m <sup>3</sup>	319	12.8	228	9.12
	Inhalation	Rats (M)	7 hrs/d, 5 d/wk for 6 months	128 mg/m <sup>3</sup>	26.7 mg/m <sup>3</sup>	183	7.31	131	5.22
				256 mg/m <sup>3</sup>	53.3 mg/m <sup>3</sup>	343	13.7	245	9.79
	Inhalation	Rats (F)	7 hrs/d, 5 d/wk for 6 months	For 4.5 months	511 mg/m <sup>3</sup>	106.5 mg/m <sup>3</sup>	550	22	393
1280 mg/m <sup>3</sup>				267 mg/m <sup>3</sup>	691	27.6	493	19.7	
Inhalation	Rats (F)	7 hrs/d, 5 d/wk for 6 months	For 4.5 months	128 mg/m <sup>3</sup>	26.7 mg/m <sup>3</sup>	2388	6.15	110	4.39
				256 mg/m <sup>3</sup>	53.3 mg/m <sup>3</sup>	327	13.1	234	9.35
				511 mg/m <sup>3</sup>	106.5 mg/m <sup>3</sup>	449	17.9	320	12.8
				1280 mg/m <sup>3</sup>	267 mg/m <sup>3</sup>	524	21	375	15

5/17/99

D-3

DRAFT-DO NOT CITE OR QUOTE

Table D-1. Dose metric values (RISK and AMET) for various vinyl chloride studies (continued)

Reference	Route	Species	Exposure duration	Concentration or dose	Human equivalent concentration Dur Adj × blood PK	Daily dose metrics		Average daily delivered dose		
						RISK	AMET	RISK	AMET	
Wisniewska-Knypl et al. (1980)	Inhalation	Wistar rats (M)	5 hr/day, 5 d/wk for 1 month	0 mg/m <sup>3</sup>	0 mg/m <sup>3</sup>					
				128 mg/m <sup>3</sup>	19 mg/m <sup>3</sup>	144	5.75	103	4.11	
				1280 mg/m <sup>3</sup>	190 mg/m <sup>3</sup>	730	29.2	521	20.9	
				51,100 mg/m <sup>3</sup>	7604 mg/m <sup>3</sup>	1230	49	876	35	
			5 hr/day, 5 d/wk for 3 months	0 mg/m <sup>3</sup>	0 mg/m <sup>3</sup>					
				128 mg/m <sup>3</sup>	19 mg/m <sup>3</sup>	140	5.6	100	4	
				1280 mg/m <sup>3</sup>	190 mg/m <sup>3</sup>	690	27.6	493	19.7	
				51,100 mg/m <sup>3</sup>	7604 mg/m <sup>3</sup>	1170	46.8	835	33.4	
			5 hr/day, 5 d/wk for 6 months	0 mg/m <sup>3</sup>	0 mg/m <sup>3</sup>					
				128 mg/m <sup>3</sup>	19 mg/m <sup>3</sup>	135	5.4	96.4	3.86	
				1280 mg/m <sup>3</sup>	190 mg/m <sup>3</sup>	704	28.2	503	20.1	
				51,100 mg/m <sup>3</sup>	7604 mg/m <sup>3</sup>	1150	46	821	32.9	
			5 hr/day, 5 d/wk for 10 months	0 mg/m <sup>3</sup>	0 mg/m <sup>3</sup>					
				128 mg/m <sup>3</sup>	19 mg/m <sup>3</sup>	130	5.21	93	3.72	
				1280 mg/m <sup>3</sup>	190 mg/m <sup>3</sup>	649	26	463	18.5	
				51,100 mg/m <sup>3</sup>	7604 mg/m <sup>3</sup>	1130	45.3	809	32.4	
Feron et al. (1981)	Diet	Wistar rats (M)	135 wks	0 mg/kg-d						
				1.7 mg/kg-d		39.5	1.58	39.5	1.58	

Table D-1. Dose metric values (RISK and AMET) for various vinyl chloride studies (continued)

Reference	Route	Species	Exposure duration	Concentration or dose	Human equivalent concentration	Daily dose metrics		Average daily delivered dose		
					Dur Adj × blood PK	RISK	AMET	RISK	AMET	
		Wistar rats (F)	144 wks	5.0 mg/kg-d		116.1	4.64	116.1	4.64	
				14.1 mg/kg-d		326	13	326	13	
				0 mg/kg-d						
				1.7 mg/kg-d		38.6	1.54	38.6	1.54	
				5.0 mg/kg-d		113.2	4.53	113.2	4.53	
				14.1 mg/kg-d		317	12.7	317	12.7	
Til et al. (1983, 1991)	Diet	Wistar rats (M)	149 wks	0 mg/kg-d						
				0.014 mg/kg-d		0.326	0.013	0.326	0.013	
				0.13 mg/kg-d		3.026	0.121	3.026	0.121	
				1.3 mg/kg-d		30.2	1.21	30.2	1.21	
		Wistar rats (F)	149 wks	0 mg/kg-d						
				0.014 mg/kg-d		0.318	0.013	0.318	0.013	
				0.13 mg/kg-d		2.958	0.118	2.958	0.118	
				1.3 mg/kg-d		29.6	1.19	29.6	1.19	

### D.2.1. Default NOAEL Approach

Because VC may be considered a category 3 gas (water insoluble, perfusion limited), the default RfC approach would be to multiply the duration-adjusted NOAEL or LOAEL by the ratio of the blood/air partition coefficients in the human and the animal or by 1 if the partition coefficient is larger in animals than in humans (which is the case for VC as shown in Table A-1; PB = 2.26 for mice, 2.4 for rat, and only 1.16 for humans) to obtain the human equivalent concentration (HEC). This is a reasonable first approximation to the expected cross-species relationship of exposures to a volatile, lipophilic chemical such as VC, because in an inhalation exposure, the average blood concentration of such a chemical during the exposure will be proportional to the air concentration multiplied by the blood/air partition coefficient. For the default RfD approach, equivalent doses for animals and humans on a mg/kg-day basis are assumed.

Using the default RfD and RfC approaches, the candidate NOAELs and LOAELs, and the corresponding duration-adjusted NOAEL<sub>[HEC]</sub> and LOAEL<sub>[HEC]</sub> values are listed below. (Note that the same nominal NOAEL or LOAEL concentration can correspond to different duration-adjusted values for different studies, due to different exposure protocols.)

#### Oral Studies

- Til et al. (1983, 1991)  
Increased incidence of hepatic cysts and of liver cell polymorphisms graded moderate and severe:  
NOAEL = 0.13 mg/kg-day; LOAEL = 1.3 mg/kg-day
- Feron et al. (1981)  
Increased extensive liver necrosis:  
In females, NOAEL = 1.7 mg/kg-day; LOAEL = 5.0 mg/kg-day  
In males, NOAEL = 5.0 mg/kg-day; LOAEL = 14.1 mg/kg-day

#### Inhalation Studies

- Bi et al. (1985)  
Increased relative liver weight:  
NOAEL, none  
LOAEL = 25.6 mg/m<sup>3</sup>; LOAEL<sub>[HEC]</sub> = 5.5 mg/m<sup>3</sup>  
  
Increased testicular degeneration:  
NOAEL = 25.6 mg/m<sup>3</sup>; NOAEL<sub>[HEC]</sub> = 5.5 mg/m<sup>3</sup>  
LOAEL = 256 mg/m<sup>3</sup>; LOAEL<sub>[HEC]</sub> = 55 mg/m<sup>3</sup>
- Sokal et al. (1980)  
Increased relative liver weight and liver lesions (nuclear polymorphism of hepatocytes, proliferation of reticulo-endothelial cells):  
NOAEL = 128 mg/m<sup>3</sup>; NOAEL<sub>[HEC]</sub> = 19 mg/m<sup>3</sup>  
LOAEL = 1278 mg/m<sup>3</sup>; LOAEL<sub>[HEC]</sub> = 190 mg/m<sup>3</sup>

Increased damage of spermatogenic epithelium:  
NOAEL = 128 mg/m<sup>3</sup>; NOAEL<sub>[HEC]</sub> = 19 mg/m<sup>3</sup>  
LOAEL = 1278 mg/m<sup>3</sup>; LOAEL<sub>[HEC]</sub> = 190 mg/m<sup>3</sup>

- Torkelson et al. (1961) (6-month point)  
Increased relative liver weight:  
NOAEL = 128 mg/m<sup>3</sup>; NOAEL<sub>[HEC]</sub> = 26.6 mg/m<sup>3</sup>  
LOAEL = 256 mg/m<sup>3</sup>; LOAEL<sub>[HEC]</sub> = 53.3 mg/m<sup>3</sup>
- Wisniewska-Knypl et al. (1980) (3-month point)  
Lipid accumulation:  
LOAEL = 128 mg/m<sup>3</sup>; LOAEL<sub>[HEC]</sub> = 19 mg/m<sup>3</sup>

The principal study for the RfD is the chronic study of Til et al. (1983, 1991) in which the oral animal dose of 0.13 mg/kg-day was a NOAEL with liver cysts and liver cell polymorphism occurring at the highest dose of the study, 1.3 mg/kg-day.

Without the PBPK modeling making route-to-route extrapolation feasible, the principal study for the RfC would probably be that of Bi et al. (1985), in which no NOAEL was identified and the lowest exposure level (10 ppm, or 25.6 mg/m<sup>3</sup>) was identified as a LOAEL for increased liver/body weight ratio after a 6-month exposure. Adjusting from exposure for 6 hr/day, 6 days/wk to continuous exposure yields an adjusted LOAEL of 5.5 mg/m<sup>3</sup>. As shown in Table B-3 of Appendix B, the measured blood/air partition coefficients (shown as PB in the table, but referred to in the RfC process as  $\lambda$ ) in the rat and the human are 2.4 and 1.16, respectively. Because the ratio of the animal to human partition coefficients (2.4/1.14 = 2.1) is greater than 1, a default value of 1 is used in accordance with EPA guidance (U.S. EPA, 1994). Therefore, the resulting LOAEL<sub>[HEC]</sub> is the same as the duration-adjusted value, 5.5 mg/m<sup>3</sup>.

### D.2.2. PBPK NOAEL Approach

The traditional approach can be readily adapted to the use of target tissue dose using the PBPK model. The critical study and NOAEL/LOAEL are selected in the same way, except that the exposure is characterized by the target tissue dose from the PBPK model. As discussed in the earlier section on the selection of the noncancer risk assessment approach, liver toxicity is assumed to result from reactive species generated during metabolism and is modeled using the RISK dose metric, which is based on the total amount of metabolism divided by the liver volume (mg metabolites/L liver). For testicular effects, toxicity is assumed to result from locally generated reactive metabolites, and the dose metric AMET is used, which is based on the total amount of metabolism divided by body weight. To obtain an average daily dose metric that is equivalent to the adjusted concentration in the traditional approach, the PBPK model is run for 24 hours and the resulting daily dose metric is then adjusted by the number of days per week the exposure took place. An alternative approach for chemicals that are not as rapidly cleared as VC is to run the model for several weeks (simulating both exposure days and nonexposure days), until steady state is reached, and then divide the weekly increase in the dose metric by 7 to obtain the average daily value. Unlike the traditional approach, however, no adjustment is necessary for the



number of hours of exposure per day, because the model incorporates this information into the prediction of the daily dose metric. Consideration of the average daily dose metric values associated with statistically significant responses indicates several candidate NOAELs and LOAELs as follows:

#### Oral Studies

- Til et al. (1983, 1991)  
Increased incidence of hepatic cysts and of liver cell polymorphisms graded moderate and severe:  
NOAEL at RISK = 2.96 mg/L; LOAEL at RISK = 29.6 mg/L in females  
NOAEL at RISK = 3.03 mg/L; LOAEL at RISK = 30.2 mg/L in males
- Feron et al. (1981)  
Increased extensive liver necrosis:  
NOAEL at RISK = 38.6 mg/L; LOAEL at RISK = 113 mg/L in females  
NOAEL at RISK = 116 mg/L; LOAEL at RISK = 326 mg/L in males

#### Inhalation Studies

- Bi et al. (1985)  
Increased relative liver weight: no NOAEL; LOAEL at RISK = 32.5 mg/L  
Increased testicular degeneration: NOAEL at AMET = 1.30 mg/kg; LOAEL at AMET = 12.5 mg/kg
- Sokal et al. (1980)  
Increased relative liver weight and liver lesions (nuclear polymorphism of hepatocytes, proliferation of reticulo-endothelial cells):  
NOAEL at RISK = 111 mg/L; LOAEL at RISK = 556 mg/L  
  
Increased damage of spermatogenic epithelium:  
NOAEL at AMET = 4.46 mg/kg; LOAEL at AMET = 22.3 mg/kg
- Torkelson et al. (1961)  
Increased relative liver weight (at 6-month point):  
NOAEL at RISK = 110 mg/L; LOAEL at RISK = 234 mg/L in females  
NOAEL at RISK = 131 mg/L; LOAEL at RISK = 245 mg/L in males
- Wisniewska-Knypl et al. (1980) (at 3-month point)  
Lipid accumulation: no NOAEL; LOAEL at RISK = 93 mg/L.

This analysis is codified in Table D-2, in which are included the dose metrics calculated for the reproductive study of Short et al. (1986). Consideration of either AMET or RISK shows clearly the sensitivity of the liver endpoint in the Til et al. (1983, 1991) study when compared with other studies, either inhalation or oral, or other endpoints, either testicular or reproductive effects.

**Table D-2. Dose metrics (AMET and RISK) derived for oral and inhalation exposure scenarios using a PBPK model (Clewell et al., 1995b) compared with effects observed in various studies**

Reference	Dose metrics		Effects <sup>a</sup>		
	AMET <sup>b</sup>	RISK <sup>c</sup>	Liver	Testicular	Reproductive
Til et al. (1991)	0.013	0.3	—	—	NE
Til et al. (1991)	0.12	3	—	—	NE
Til et al. (1991)	1.2	30	0	—	NE
Bi et al. (1985)	1.3	33	0	—	NE
Feron et al. (1981)	1.6	40	0	—	NE
W-N et al. (1980)	3.7	93	0	NE	NE
Sokal et al. (1980)	4.5	111	—	—	NE
Feron et al. (1981)	4.6	116	0	—	NE
Short et al. (1986)	~7	~180	NE	NE	—
Bi et al. (1985)	12.5	312	0	0	0
Feron et al. (1981)	13	326	0	—	NE
Sokal et al. (1980)	22	556	0	0	NE
Short et al. (1986)	~23	~580	0	0	0
Short et al. (1986)	~32	~800	NE	NE	0
Bi et al. (1985)	43	1080	0	0	NE
Sokal et al. (1980)	37	927	0	0	NE

<sup>a</sup>— = NOAE, 0 = OAE, NE = not examined for.

<sup>b</sup>AMET: Total amount of VC metabolism divided by body weight (average daily mg metabolite/kg-day). Male values given.

<sup>c</sup>RISK: Total amount of VC metabolized by the liver divided by the volume of the liver (average daily mg metabolite/L liver). Male values given.

To convert these dose metrics into an HEC, the PBPK model must be run to determine the continuous human exposure associated with each dose metric value of RISK and/or AMET. Table D-3 shows the results of this exercise, where the dose metrics associated with human continuous exposures range from 1  $\mu\text{g}/\text{m}^3$  through 10,000  $\text{mg}/\text{m}^3$ . These results show that in the case of VC the model is linear to nearly 100  $\text{mg}/\text{m}^3$ . This simplifies the calculation of HECs, because the appropriate equivalence factor can thus be used: 0.68  $(\text{mg}/\text{L})/(\text{mg}/\text{m}^3)$  for RISK, or 0.0177  $(\text{mg}/\text{kg})/(\text{mg}/\text{m}^3)$  for AMET. Similarly, the equivalence factor for oral dosing was calculated by determining the human dose metric corresponding to a sample near-continuous exposure scenario (1 ppm in water, corresponding to 0.0286  $\text{mg}/\text{kg}\text{-day}$ , assuming ingestion of 2 L/day by a 70 kg person). The corresponding dose metric of 0.581 was shown earlier in Table B-1. As with inhalation exposure, VC metabolism is linear in this dose range, so the equivalence factor for RISK is 20.31  $(\text{mg}/\text{L})/(\text{mg}/\text{kg}\text{-day})$ . Liver toxicity was the only endpoint of concern for oral exposure, so equivalence factors for the other dose metrics were not calculated. To obtain the HEC for each animal NOAEL or LOAEL, the animal dose metric was divided by the human dose metric equivalence factor:

#### Oral Studies

- Til et al. (1983, 1991)  
Increased incidence of hepatic cysts and of liver cell polymorphisms graded moderate and severe:  
NOAEL at  $2.96/20.31 = 0.15 \text{ mg}/\text{kg}\text{-day}$ ; LOAEL at  $29.5/20.31 = 1.5 \text{ mg}/\text{kg}\text{-day}$  in females  
NOAEL at  $3.03/20.31 = 0.15 \text{ mg}/\text{kg}\text{-day}$ ; LOAEL at  $30.2/20.31 = 1.5 \text{ mg}/\text{kg}\text{-day}$  in males
- Feron et al. (1981)  
Increased extensive liver necrosis:  
NOAEL at  $38.6/20.31 = 1.9 \text{ mg}/\text{kg}\text{-day}$ ; LOAEL at  $113/20.31 = 5.6 \text{ mg}/\text{kg}\text{-day}$  in females  
NOAEL at  $116/20.31 = 5.7 \text{ mg}/\text{kg}\text{-day}$ ; LOAEL at  $326/20.31 = 16 \text{ mg}/\text{kg}\text{-day}$  in males

These same dose metrics can be converted to HECs for inhalation exposure, using the inhalation equivalence factor:

- Til et al. (1983, 1991)  
Increased incidence of hepatic cysts and of liver cell polymorphisms graded moderate and severe:  
NOAEL<sub>(HEC)</sub> at  $2.96/0.68 = 4.4 \text{ mg}/\text{m}^3$ ; LOAEL<sub>(HEC)</sub> at  $29.5/0.68 = 43.4 \text{ mg}/\text{m}^3$  in females  
NOAEL<sub>(HEC)</sub> at  $3.03/0.68 = 4.5 \text{ mg}/\text{m}^3$ ; LOAEL<sub>(HEC)</sub> at  $30.2/0.68 = 44.4 \text{ mg}/\text{m}^3$  in males
- Feron et al. (1983, 1991)  
Increased extensive liver necrosis:  
NOAEL<sub>(HEC)</sub> at  $38.6/0.68 = 56.8 \text{ mg}/\text{m}^3$ ; LOAEL<sub>(HEC)</sub> at  $113/0.68 = 166 \text{ mg}/\text{m}^3$  in females  
NOAEL<sub>(HEC)</sub> at  $116/0.68 = 170 \text{ mg}/\text{m}^3$ ; LOAEL<sub>(HEC)</sub> at  $326/0.68 = 479 \text{ mg}/\text{m}^3$  in males

### Inhalation Studies

- Bi et al. (1985)  
Increased relative liver weight:  $LOAEL_{[HEC]}$  at  $32.5/0.68 = 47.8 \text{ mg/m}^3$   
  
Increased testicular degeneration:  $NOAEL_{[HEC]}$  at  $1.30/0.0177 = 73.4 \text{ (mg/m}^3)$   $LOAEL_{[HEC]}$  at  $12.5/0.0177 = 706 \text{ mg/m}^3$
- Sokal et al. (1980)  
Increased relative liver weight and liver lesions:  $NOAEL_{[HEC]}$  at  $111/0.68 = 162 \text{ mg/m}^3$ ;  
 $LOAEL$  at  $556/0.68 = 818 \text{ mg/m}^3$   
  
Increased damage of spermatogenic epithelium:  $NOAEL$  at  $4.46/0.0177 = 252 \text{ mg/m}^3$ ;  
 $LOAEL$  at  $22.3/0.0177 = 1260 \text{ mg/m}^3$
- Torkelson et al. (1961)  
Increased relative liver weight:  
 $NOAEL_{[HEC]}$  at  $110/0.68 = 162 \text{ mg/m}^3$ ;  $LOAEL_{[HEC]}$  at  $234/0.68 = 344 \text{ mg/m}^3$  in females  
 $NOAEL_{[HEC]}$  at  $131/0.68 = 193 \text{ mg/m}^3$ ;  $LOAEL_{[HEC]}$  at  $245/0.68 = 360 \text{ mg/m}^3$  in males
- Wisniewska-Knypl et al. (1980)  
Lipid proliferation:  $LOAEL_{[HEC]}$  at  $93/0.68 = 137 \text{ mg/m}^3$

**Table D-3. Daily dose metrics (RISK and AMET) obtained by running the PBPK model (Clewel et al., 1995a) under conditions of continuous human exposure**

Concentration (mg/m <sup>3</sup> )	Dose metric	
	RISK	AMET
0.001	$6.82 \times 10^{-4}$	$1.77 \times 10^{-5}$
0.01	$6.82 \times 10^{-3}$	$1.77 \times 10^{-4}$
0.1	$6.82 \times 10^{-2}$	$1.77 \times 10^{-3}$
1	0.682	0.0177
10	6.82	0.177
100	66.5	1.73
1000	516	13.4
10,000	1163	30.2

Summarizing the above results, the lowest LOAEL was for increased relative liver weight in a subchronic study, just as it was for the traditional approach, but the resulting LOAEL<sub>[HEC]</sub> is 47.8 mg/m<sup>3</sup>, about ninefold higher than the value of 5.5 mg/m<sup>3</sup> arrived at without considering pharmacokinetics. The reason for the difference is that the default approach is based on parent chemical exposure, whereas the PBPK approach used a dose metric (RISK) representing exposure to reactive metabolites. Use of the PBPK model also allows for extrapolation from the oral route, in which a NOAEL<sub>(HEC)</sub> of 4.5 mg/m<sup>3</sup> (average of male and female values) was identified. For the oral assessment, a NOAEL of 0.15 mg/kg-day (average of male and female values) was identified, a dose very close to the animal dose of 0.13 mg/kg-day that would be used in the absence of the model.

The overall approach just described is actually an approximate method that is acceptable for VC. The correct approach in general is to apply the desired uncertainty factor to the animal dose metric to obtain the lower target tissue dose desired in the human; the human PBPK model is then run iteratively to estimate the concentration associated with the desired human target tissue dose (Clewell and Jarnot, 1994). However, due to the linearity of the human dose metric for VC over the region of interest, the two formulations are equivalent in the case of VC.

### **D.2.3. Benchmark Dose Modeling**

When possible, dose-response analysis of the results of the VC studies was also performed using the benchmark dose (BMD) methodology (Crump, 1984, 1995). When used with exposure concentrations, this approach is sometimes referred to as the benchmark concentration (BMC) methodology. The BMD (BMC) is the dose (concentration) predicted to result in a specified amount of increased risk (called the “benchmark risk”). The BMD or BMC is calculated using a statistical dose-response model applied to either experimental toxicological or epidemiological data. It has been proposed that a statistical lower bound on the BMD or BMC (referred to as the BMDL or BMCL, respectively) may be used in the setting of acceptable exposure limits as a replacement for the traditional NOAEL, which must be selected from one of the actual experimental dosing levels (U.S. EPA, 1994; Gaylor and Slikker, 1990).

In the traditional approach for estimating a NOAEL from animal data, the response at each of the experimental doses is compared statistically with that in the controls, and the NOAEL is defined as the lowest dose showing no statistical difference. The benchmark approach has several advantages over the traditional NOAEL approach: (1) the benchmark approach makes better use of the dose-response information inherent in the data; (2) the benchmark approach appropriately reflects the sample size of a study (smaller studies tend to result in smaller BMDs or BMCs, whereas the opposite is true for traditionally derived NOAELs); (3) the benchmark approach does not require arbitrary categorization of the data in epidemiological studies; (4) the benchmark approach does not involve difficult and argumentative “all or nothing” decisions, such as determining whether or not a NOAEL was observed in a particular experimental dose or exposure category; and (5) a benchmark estimate of the NOAEL can be determined even when effects are observed in the lowest experimental dose group or exposure category. In its report, “Interim Methods for Development of Inhalation Reference Concentrations” (U. S. EPA, 1994), the EPA stated: “This novel method utilizes more of the available data than the current

methodology .... It also addresses to some degree several of the criticisms of the current approach, such as the use of dose-response slopes and the number of animals tested in defining NOELs.”

#### **D.2.4. Quantal Benchmark Results**

Calculations of BMDs and BMCs for quantal (incidence) data in the present study were performed with the standard quantal benchmark programs, THRESH and THRESHW (KS Crump Group, ICF Kaiser International, Ruston, LA), which employ the polynomial and Weibull models, respectively:

Polynomial model:

$$P(d) = p_0 + (1-p_0) * (1 - \exp\{-[\beta_1(d - d_0) + \beta_2(d - d_0)^2 + \dots + \beta_k(d - d_0)^k]\})$$

Weibull model:

$$P(d) = p_0 + (1-p_0) * (1 - \exp\{-[\beta(d - d_0)^k]\})$$

where  $p_0$  is the proportion of responses in the control group, and  $d_0$  is a threshold below which no increase in response is expected to occur.

A key step in the use of BMD modeling for the calculation of RfDs and RfCs is in the choice of the benchmark response level (BMR). This issue is an area of ongoing research, and the appropriate choices are better defined for quantal endpoints than for continuous endpoints. However, the following may be considered. For developmental toxicity, a set of studies sponsored by the EPA (Faustman et al., 1994; Allen et al., 1994a, 1994b; Kavlock et al., 1995) has indicated choices for the response levels that yield BMDs that are, on average, similar to corresponding NOAELs. No large-scale studies comparable to those conducted for developmental toxicity have been completed for other types of toxicity. Thus, it is not as clear for such endpoints how to define the BMDs. However, Allen et al. (1994a) investigated a quantal treatment of developmental toxicity endpoints (counting the number of litters per group with one or more affected fetus). Such a treatment of developmental toxicity endpoints should not be much different from any other quantal endpoint. Allen et al. (1994a) determined that a BMD corresponding to a 10% increase in risk (BMD10) tended to match the associated NOAELs better than other choices (5% and 1% increases). About 76% of the BMDs for 10% additional risk were less than the corresponding NOAELs, but the median of the relative differences was a factor of 2. BMDs corresponding to an additional risk of 10% also have the advantage that they are likely to depend less on the dose-response model than BMDs corresponding to additional risk of 1% or 5% (Crump, 1984). These analyses suggest that use of a lower bound for 10% additional risk would increase the conservatism in the determination of RfCs and RfDs by a factor of about 2 to 3 (i.e., would decrease RfCs and RfDs by a factor of 2 to 3 on average) compared to the traditional NOAEL approach. The BMD10 values are highlighted in the presentation of the benchmark modeling results to indicate the values that should be compared for different endpoints. However, it should be noted that this study was conducted using additional risk, whereas EPA is using extra risk as a conservative default. The concentration corresponding to a given extra risk will always be the same or lower than the concentration corresponding to the

same percentage of additional risk. Additional risk is defined as  $P(d) - P(0)$ , while extra risk is defined as  $[P(d) - P(0)]/[1 - P(0)]$ .

The following data sets were suitable for analysis: (1) incidence of testicular degeneration in rats exposed to VC by inhalation for 3–18 months (Bi et al., 1985), (2) incidence of extensive necrosis in the liver of rats chronically exposed to VC in the diet (Feron et al., 1981), (3) incidence of nuclear polymorphism of hepatocytes in rats exposed to VC by inhalation for 10 months (Sokal et al., 1980), (4) incidence of proliferation of hepatic reticulo-endothelial cells in rats exposed to VC by inhalation for 10 months (Sokal et al. 1980), and (5) incidence of damage to spermatogenic epithelium in rats exposed to VC by inhalation for 10 months (Sokal et al., 1980). No incidence data were reported for lipid proliferation in the study by Wisniewska-Knypl et al., (1980), so these data could not be modeled. Although modeling of the data was based on the PBPK dose metrics, selected endpoints also were modeled based on the exposure levels or administered doses, for comparison.

*Dose/Exposure Concentration:* The results of the quantal benchmark modeling of the administered dose (in mg/kg-day) or exposure concentration (in mg/m<sup>3</sup>) were shown in Table C-3. An acceptable fit was obtained with all endpoints, with one exception. Poor fit was obtained in the liver necrosis data of Feron et al. (1981) when the diet and gavage data were combined, but a good fit was obtained when the diet data alone were modeled. This is the expected result, because the response and dose metric of the gavage dose were lower than the highest dietary dose, even though the administered gavage dose was higher (300 mg/kg-day versus 14.1 mg/kg-day). The BMC10 (for 10% extra risk) estimated for the sample data sets are as follows:

#### Oral Studies

- Til et al. (1983, 1991) (see below)
- Feron et al. (1981)  
Increased extensive liver necrosis in females: BMD10 at 1.8 mg/kg-day  
Increased extensive liver necrosis in males: BMD10 at 3.0 mg/kg-day

#### Inhalation Studies

- Bi et al. (1985)  
Increased testicular degeneration: BMC10 at 229 mg/m<sup>3</sup>

Thus, the BMC10 estimated for the testicular effect of Bi et al., (1985) is higher than the LOAEL<sub>[HEC]</sub> estimated using the traditional NOAEL approach. Analysis of the modeling output indicates that this overestimate results from poor fit in the low concentration region. In order to fit the moderate increase in response corresponding to the 30x increase in exposure level between the middle and high concentrations, the model underestimated the response in the low concentration region. The goodness-of-fit p value (0.08) is low but acceptable, indicating the importance of evaluating the fit in the low concentration region, in addition to the overall p value. The BMD for the liver necrosis in the oral study was comparable to the NOAEL in females, and between the NOAEL and LOAEL in males. The calculated BMDs were approximately an order of magnitude higher when the gavage dose was included in the modeling, reflecting the poor model fit with this data set.

*Delivered Dose:* The results of the quantal benchmark analysis using doses from the PBPK model were shown in Table C-4 (in units of the appropriate dose metric, and converted to the exposure concentration). The following data sets were analyzed: (1) incidence of testicular degeneration in rats exposed to VC by inhalation for 3 to 18 months (Bi et al., 1985), (2) incidence of extensive necrosis in the liver of male and female rats chronically exposed to VC in the diet (Feron et al., 1981), (3) incidence of nuclear polymorphism of hepatocytes in rats exposed to VC by inhalation for 10 months (Sokal et al., 1980), (4) incidence of proliferation of hepatic reticulo-endothelial cells in rats exposed to VC by inhalation for 10 months (Sokal et al., 1980), and (5) incidence of damage to spermatogenic epithelium in rats exposed to VC by inhalation for 10 months (Sokal et al., 1980). Note that, although the same dose metric is used for different effects in the same organ, separate BMDs are calculated because the response data differ. Acceptable fits were obtained for all endpoints, and the BMCs obtained with the two BMD models are identical or very similar in all cases. The BMC10 (for 10% extra risk) estimated for each animal data set was converted to the corresponding HEC (which will be referred to as the  $BMC_{[HEC]}$ ) using the appropriate equivalence factor, 0.68 (mg/L)/(mg/m<sup>3</sup>) for RISK, or 0.0177 (mg/kg)/(mg/m<sup>3</sup>) for AMET, in the same way as in the PBPK NOAEL/LOAEL approach. Similarly, the BMD10 was converted to the equivalent human dose using the equivalence factors of 20.31 (mg/L)/(mg/kg-day) for RISK.

#### Oral Studies

- Til et al. (1983, 1991) (see below)
- Feron et al. (1981)  
Increased liver necrosis in females: BMD at 40.4/20.31 = 2.0 mg/kg-day  
Increased liver necrosis in males: BMD at 70.0/20.31 = 3.45 mg/kg-day

These same dose metrics can be converted to HECs for inhalation exposure, using the inhalation equivalence factor:

Increased liver necrosis in females:  $BMC_{[HEC]}$  at 40.4/0.68 = 59 mg/m<sup>3</sup>  
Increased liver necrosis in males:  $BMC_{[HEC]}$  at 69.6/0.68 = 102 mg/m<sup>3</sup>

For comparison, the following data were obtained when the gavage dose of Feron et al. (1981) was included in the benchmark modeling, and the results were converted to a human inhalation HEC:

Increased liver necrosis in females:  $BMC_{[HEC]}$  at 37.4/0.68 = 55 mg/m<sup>3</sup>  
Increased liver necrosis in males:  $BMC_{[HEC]}$  at 65.6/0.68 = 96 mg/m<sup>3</sup>



## Inhalation Studies

- Bi et al. (1985)  
Increased testicular degeneration:  $BMC_{[HEC]} \text{ at } 5.60/0.0177 = 316 \text{ mg/m}^3$
- Sokal et al. (1980)  
Nuclear proliferation of hepatocytes:  $69.1/0.68 = 102 \text{ mg/m}^3$   
Proliferation of hepatic reticulo-endothelial cells:  $109/0.68 = 160 \text{ mg/m}^3$   
Damage of spermatogenic epithelium:  $3.75/0.0177 = 212 \text{ mg/m}^3$

Thus, the BMCs calculated including the gavage dose are very similar to those excluding the gavage dose when the PBPK dose metric is used. As shown in Table D-4, the model fit is also much better. The better fit obtained with the BMD models when dose metrics from the PBPK model were used reflects, of course, the importance of saturation of metabolism in the toxicity of VC. Figure 3 in the main document compared the model fit for the female data when the gavage dose was included and excluded in the modeling. Figure 4 showed the same comparison for the male data.

As shown in Table D-4, acceptable fits were obtained for all of the data sets. The  $BMC_{[HEC]}$  for testicular degeneration (Bi et al., 1985) is about a factor of two below the  $LOAEL_{[HEC]}$  ( $706 \text{ mg/m}^3$  based on target tissue dose) for the same study, whereas the  $BMC_{[HEC]}$  for liver necrosis is comparable to the  $NOAEL_{[HEC]}$  ( $57 \text{ mg/m}^3$  or  $1.9 \text{ mg/kg-day}$  based on target tissue dose) for the same study. It is also noteworthy that the  $BMC_{[HEC]}$  for testicular degeneration is about a factor of four above the  $NOAEL_{[HEC]}$  ( $73.4 \text{ mg/m}^3$  based on target tissue dose) for the same study, demonstrating the value of the BMD approach when the dose levels in a study are widely spaced. Although similar BMCs were calculated using extra and additional risk for most endpoints, the BMC for testicular degeneration using additional risk is about 30% higher than the value calculated using extra risk, because of the high background response for this endpoint.

The response for the testicular endpoint observed by Sokal et al. (1980) at the high concentration was lower than that at the middle concentration. This decrease does appear to be biologically meaningful. High VC concentrations destroy P450, decreasing the amount of reactive metabolites formed (Reynolds et al, 1975; Guengerich and Strickland, 1977). Thus, the highest exposure level may have knocked out the P450 system and prevented the testicular toxicity. Although the model fit was acceptable in both cases, dropping the high dose resulted in much better fit, as expected. The decrease in response was not observed for the liver lesions, apparently because of the higher P450 levels in the liver. Based on this analysis, the response was modeled with and without the high dose (additional risk) or with the high dose dropped (extra risk). As expected, dropping the high dose improved the model fit. The benchmark values calculated without the high dose are about two-thirds those calculated including the high dose.

**Table D-4. BMD<sub>10</sub> and maximum likelihood estimates (MLE) values generated from various model fits to liver cell polymorphism incidence data from exposure to vinyl chloride monomer (Til et al., 1991)**

<b>Model</b>	<b>BMD10 (MLE), mg/L liver<sup>a</sup></b>	<b>P-value</b>
Weibull (power $\geq$ 1)	24.0 (26.6)	0.88
Gammahit	21.4 (23.2)	0.88
Quantal quadratic	13.8 (16.2)	0.96
Logistic	12.9 (13.4)	0.47
Multistage	11.8 (16.2)	0.79
Probit	11.6 (12.7)	0.44
Quantal linear	6.5 (9.1)	0.46
NOAEL	3.00 (0.13 mg/kg-day)	
LOAEL	29.9 (1.3 mg/kg-day)	

<sup>a</sup>BMD<sub>10</sub> is the lower 95% confidence bound on the MLE of a 10% change in numbers exhibiting polymorphism evaluated as either moderate or severe. Results shown are generated with dose metrics (mg VC metabolites/L liver; RISK) and were generated from the PBPK model of Clewell et al. (this document). The NOAEL and LOAEL are also shown for comparative purposes.

#### **D.2.4.1. Quantal Benchmark Concentration Analyses of Liver Cell Polymorphism in Til et al. (1983, 1991)**

##### *(1) Computational Models — Discontinuous Data*

The models used are listed in Table D-4 above. For data inputs, the multistage polynomial was set to the number of dose groups minus one, the risk type was extra  $[P(d) - P(0)] / [1 - P(0)]$ , and no threshold was estimated. For the Weibull, the lower limit of  $\beta$  was set at 1. The gammahit model was run to convergence (approximately 1000 iterations).

##### *(2) Data*

Incidence data from Table 4 in Til et al. (1983, 1991) for both sexes of moderate and severe grades of liver cell polymorphism were all combined and summed to produce one control group and three exposed groups (incidence of moderate + severe)/total exposed; (21)/197 for controls, (21)/199 for 0.014 mg/kg, (20)/196 for 0.13 mg/kg, and (37)/98 for 1.3 mg/kg.

The doses were further transformed by use of the PBPK model to an average daily delivered dose in mg/L liver to the following (averaged metric values of male and female): for 0.014 mg/kg-day, 0.321 mg/L; for 0.13 mg/kg-day, 2.98 mg/L; for 1.3 mg/kg-day, 29.8 mg/L. This metric (mg/L liver) was used in the BMD modeling. BMD results were transformed to the human equivalent oral concentration by dividing this metric by 20.31 and by 0.68 to obtain the continuous human equivalent inhalation concentration (see Appendix C).

(3) *Model Fit*

Model fit was judged by the P-values given from the analysis of deviance by inspection of the observed versus predicted output from each model (not shown) and from visual inspections of the graphical outputs (not shown).

(4) *Results*

The dose-response character of liver cell polymorphism was limited, appearing as a high-dose phenomenon only. Nevertheless, all models tested fit these data acceptably, i.e.,  $p > 0.05$ . Comparison of the observed versus expected values generated from the various models also showed that all models, save for the quantal linear, gave reasonable approximations of the data. There was, however, a clear dichotomy between models giving P-values in the range of 0.8 and those giving values around 0.4. Visual inspection of the graphical (not shown) indicate that model fitting to the 0.13 mg/kg (3.00 mg/L liver) point may have accounted for this dichotomy, in that those models generating MLEs within the variability of this point gave elevated P-values whereas those models with MLEs missing this point had P-values smaller by one-half.

The range of the outputs for the various models for the BMD10 was over threefold, from 6.5 to 24.01 mg/L liver with BMD10s of 11–14 mg/L liver being intermediate. All modeled BMD10s were larger than the NOAEL of the study, 3.00 mg/L liver (0.13 mg/kg) with even the lowest modeled BMD10 (quantal linear) being over twice this value.

(5) *Discussion*

The only nonzero response in this data set is the highest dose employed, 29.9 mg/L liver, where the response rate was about 38%. The dose-spacing of the study is such that the nearest experimental point to the nonzero point is 10-fold different (3.00 versus 29.9 mg/L liver). Some models (gammahit and Weibull) generated MLE responses that remained close to the control rate of 10% until near the nonzero point where they rose steeply. Others (e.g., logistic, probit, and multistage) generated MLE responses that sloped upward more gradually at doses considerably less than the nonzero point. The implication for model choice is appreciable. The range between the NOAEL and the highest BMD10 (Weibull) is eightfold. The range between the NOAEL and the lowest BMD10 (quantal linear) is slightly more than twofold.

No biological reasoning governs the choice of any of the model outputs from Table D-4. The character of the dose response is highly uncertain because of the large spacings between applied doses. Due to this uncertainty and the lack of biological motivation for model choice, the NOAEL, 3.00 mg/L liver, is chosen for use as the basis for further quantitative analysis for both oral and inhalation assessments. The HECs are derived from the output of the PBPK model as shown in this Appendix. The oral NOAEL(HEC) is 0.15 mg/kg-day (3.00 mg/L liver /20.31). The inhalation NOAEL(HEC) is 4.5 mg/m<sup>3</sup> (3.00 mg/L liver/ 0.68).

### **D.3. PHARMACOKINETIC SENSITIVITY ANALYSIS**

Table B-6 showed the normalized analytical sensitivities for the PBPK model described above. The normalized analytical sensitivity coefficient represents the fractional change in output associated with a fractional change in the input parameter. For example, if a 1% change in the input parameter results in a 2% change in the output, the sensitivity coefficient would be 2.0. In Table B-6, the outputs were the dose metrics used in the analysis of noncancer risk. The parameters in the table were defined in Tables B-3 and B-4 of Appendix B. Sensitivity coefficients of less than 0.1 in absolute value were omitted from the table for clarity. None of the parameters display sensitivities significantly greater than 1.0, indicating that there is no amplification of error from the inputs to the outputs. This is, of course, a desirable trait in a model to be used for risk assessment.

It can be seen that of the 24 parameters in the VC model, only 8 have a significant impact on risk predictions based on any of the dose metrics: the body weight (BW), alveolar ventilation (QPC), cardiac output (QCC), liver blood flow (QLC) and volume (VLC), blood/air partition coefficient (PB), and the capacity (VMAX1C) and affinity (KM1) for metabolism by CYP2E1.

## REFERENCES

- Allen, BC; Kavlock RJ; Kimmel, CA; et al. (1994a) Dose response assessments for developmental toxicity: II. Comparison of generic benchmark dose estimates with NOAELs. *Fundam Appl Toxicol* 23:487-495.
- Allen, BC; Kavlock, RJ; Kimmel, CA; et al. (1994b) Dose response assessments for developmental toxicity: III. statistical models. *Fundam Appl Toxicol* 23:496-509.
- Andersen, M; Clewell, H; Gargas, M; et al. (1987a) Physiologically based pharmacokinetics and the risk assessment process for methylene chloride. *Toxicol Appl Pharmacol* 87:185-205.
- Bi, W; Wang, Y; Huang, M; et al. (1985) Effect of vinyl chloride on testis in rats. *Ecotoxicol Environ Saf* 10:281-289.
- Clewell, HJ; Jarnot, BM. (1994) Incorporation of pharmacokinetics in non-carcinogenic risk assessment: example with chloropentafluorobenzene. *Risk Anal* 14:265-276.
- Crump, K. (1984) A new method for determining allowable daily intakes. *Fundam Appl Toxicol* 4:854-871.
- Crump, K. (1995) Calculation of benchmark doses from continuous data. *Risk Anal* 15:79-89.
- Faustman, EM; Allen, BC; Kavlock, RJ; et al. (1994) Dose response assessment for developmental toxicity: I. characterization of data base and determination of NOAELs. *Fundam Appl Toxicol* 23:478-486.
- Feron, VJ; Hendriksen, CFM; Speek, AJ; et al. (1981) Lifespan oral toxicity study of vinyl chloride in rats. *Food Cosmetol Toxicol* 19:317-333.
- Gaylor, DW; Slikker, W. (1990) Risk assessment for neurotoxic effects. *Neurol Toxicol* 11:211-218.
- Guengerich, FP; Strickland, TW. (1977) Metabolism of vinyl chloride: Destruction of the heme of highly purified liver microsomal cytochrome P-450 by a metabolite. *Molec Pharmacol* 13:993-1004.
- Kavlock, RJ; Allen, BC; Faustman, EM; et al. (1995) Dose response assessments for developmental toxicity: IV. Benchmark doses for fetal weight changes. *Fundam Appl Toxicol* 26(2):211-222.
- Reynolds, ES; Moslen, MT; Szabo, S; et al. (1975) Vinyl chloride-induced deactivation of cytochrome P-450 and other components of the liver mixed function oxidase system: an in vivo study. *Res Commun Chem Pathol Pharmacol* 12:685-694.

Sokal, JA; Baranski, B; Majka, J; et al. (1980) Experimental studies on the chronic toxic effects of vinyl chloride in rats. *J Hyg Epidem Microbiol Immunol* 24:285-294.

Torkelson, TR; Oyen, F; Rowe, VK. (1961) The toxicity of vinyl chloride as determined by repeated exposure of laboratory animals. *Am Ind Hyg Assoc J* 22:354-361.

U.S. Environmental Protection Agency (U.S. EPA). (1994) Methods for derivation of inhalation reference concentrations and application of inhalation dosimetry. EPA/600/8-90/066F. Office of Health and Environmental Assessment, Washington, DC.

Watanabe, PG; Zempel, JA; Pegg, DG; et al. (1978) Hepatic macromolecular binding following exposure to vinyl chloride. *Toxicol Appl Pharmacol* 44:571-579.

Wisniewska-Knypl, JM; Klimczak, J; Kolakowski, J. (1980) Monooxygenase activity and ultrastructural changes of liver in the course of chronic exposure of rats to vinyl chloride. *Int Arch Occup Environ Health* 46(3):241-249.

## APPENDIX E. EXTERNAL PEER REVIEW—SUMMARY OF COMMENTS AND DISPOSITION

The Toxicological Review and IRIS summaries for vinyl chloride have undergone both internal peer review performed by scientists within EPA and a more formal external panel peer review performed by scientists chosen in accordance with the Standard Operating Procedures for Peer Review (U.S. EPA, 1994c). Comments made by the internal reviewers were addressed prior to submitting the documents for external peer review and are not part of this appendix. The external peer reviewers were tasked with addressing general questions on the overall assessment and on chemical - specific questions in areas of scientific controversy or uncertainty. A summary of comments made by the external reviewers based upon questions posed to them and EPA's response to these comments are presented below.

### *(1) General Question*

A. Are there any other data/studies that are relevant (i.e., useful for the hazard identification or dose-response assessment) for the assessment of the adverse health effects, both cancer and noncancer, of this chemical.

The eleven external peer reviewers offered editorial comments and many minor, but valuable suggestions, all of which have been considered for incorporation into the text to the extent feasible. The reviewers identified a number of publications for inclusion in the support document.

*Response:* Copies of the publications identified by the reviewers have been acquired and the appropriate ones were incorporated into the summaries and the support document.

### *(2) Chemical Specific Questions Posed to Panelists*

A. Is the pharmacokinetic (PBPK) model developed for this assessment adequate for quantifying cancer and noncancer risk of VC exposure. Several questions regarding the adequacy of the model were discussed. An aspect of considerable discussion concerned whether the use of a two-pathway model is an improvement over previous models using a single metabolic activation pathway. Several individuals felt that it was not an improvement over the single pathway models because the lower dose ranges, where the low affinity pathway produces few metabolites, are of greatest human interest. It was also pointed out that there is little evidence for a second metabolic activation pathway in humans. The general feeling was that a two-pathway model was an unnecessary increase in complexity but nevertheless acceptable.

One reviewer questioned the use of an undocumented model when models published in the peer reviewed literature were available. However, it was pointed out that both the present model and one published by Reitz et al. in 1996 predicted similar internal dose measures.

The possibility that the active metabolite chlorethylene oxide (CEO) formed in the liver could migrate to other tissues was discussed. It was concluded that due to its reactivity this was unlikely to occur. It was also concluded that other tissues brain, kidney etc. may have limited metabolic capability, but was likely to be small in relation to the liver. Because of these conclusions it was generally agreed that modeling concentration of CEO in the liver was an acceptable approach to assess risk from VC exposure.

In general, the reviewers felt that while use of the model presented some uncertainties that require discussion in the Toxicological Review, it is a fairly standard model and its use for quantitating risk will lead to acceptable potency estimates.

*Response:* Use of the two-pathway model was retained. While assumption of a second pathway in rats and mice (a second pathway is not assumed for humans in the model) may be unnecessary, its inclusion is not considered likely to introduce errors in estimating liver concentration of the active metabolite.

The PBPK model used for VC is an adaptation of a model published earlier for vinylidene chloride and its use for estimating cancer risk from VC exposure has been described in the literature. Thus, it is not considered to be undocumented.

B. Should human data be used to quantitate risk, and if not, were the animal studies selected the proper ones.

Two reviewers believed that human data was adequate. Three studies were cited as being useful for this purpose and the possibility of obtaining unpublished data was alluded to. This data, however, has not been provided to EPA to date. Several others believed that an attempt should be made to evaluate human data further to determine its possible use for either quantitating cancer risk or confirming the animal based risks.. On the other hand, the only epidemiologist among the reviewers believed that human exposure levels are too uncertain to base human risk upon epidemiology data. There was general agreement that the correct animal studies were selected.

*Response:* Published epidemiology studies have a considerable uncertainty. In the largest and best documented one, the mean age of the cohort was only 54 years. The development of liver tumors in an unknown additional number of subjects can therefore be anticipated. The subjects worked in a number of different facilities in different countries so exposures varied and were very uncertain. Uncertainty is also increased due to the small numbers of subjects with liver tumors in many of the cohorts.

On the other hand, a large number of animal studies have been carried out utilizing a wide range of doses. Both oral and inhalation studies of suitable quality are available. The primary tumor site, the liver, is relevant to human response. Two species, mice and rats, have been shown to have similar susceptibilities, increasing confidence that responses may be similar across species.



While the animal studies used to quantitate risk did not utilize neonates, the animals were exposed prior to adulthood. Other studies using neonates provided evidence regarding early life sensitivity not available in the human epidemiology studies. Epidemiology studies also provided no information regarding possible sex differences in sensitivity.

Although the decision was made to base cancer risk upon animal data, potency estimates based on epidemiology data are used as support for the recommended values.

C. Are neoplastic nodules reported in the Feron et al. feeding study and/or hepatomas reported in the Maltoni et al. inhalation studies appropriate for inclusion in the data sets used for cancer risk assessment.

Four reviewers, including the only animal pathologist on the panel, believed that neoplastic nodules reported in the Feron and Til studies should be included in cancer quantitation. Two reviewers disagreed and four did not comment. The dissenters felt that liver angiosarcoma was the primary endpoint in humans and should be used for quantitation, and that inclusion of all liver tumors would result in an overestimation of cancer risk. Those favoring inclusion of nodules believed that the nodules have the potential to progress to malignancy and should therefore be counted. There was general agreement that hepatomas should be included only if increases were statistically significant.

*Response :* Both angiosarcomas and hepatocellular carcinomas are induced by VC in the animal as well as epidemiology studies. Since neoplastic nodules according to pathologists are tumors (adenomas) and are capable of progressing to carcinoma it was deemed appropriate to include them. Hepatocellular tumors were also considered appropriate in assessing risk based on the inhalation studies. Although their numbers were not statistically significantly increased in the inhalation studies, they are considered to be associated with VC exposure since they were significantly increased in the oral studies. Since there are few of them, however, their effect upon cancer potency is minimal.

D. If all liver tumors were included, is risk likely to be overestimated, or would they counterbalance a possible underestimate of total risk due to possible induction of tumors at other sites. Three of the reviewers believed that including all liver tumors will result in an overestimate of cancer risk. Two felt that it might address the possibility of tumor induction at other sites. The other reviewers were either uncertain, or had no opinion.

*Response:* There is evidence from both the animal feeding studies and epidemiology studies that hepatocellular tumors as well as angiosarcomas are induced by VC. On this basis including all liver tumors, even from studies in which hepatocellular tumors were not significantly increased, is considered to be appropriate.

E. Do the confidence statements and weight-of-evidence statements present a clear picture and accurately reflect the utility of the studies chosen, the relevance of cancers as well as noncancer data to humans, and the comprehensiveness of the database. The answers were generally yes, although one reviewer suggested that we should make an effort to collect all human data, including unpublished data.

*Response:* Attempts will be made to collect any additional human data, although such data is likely to be unpublished and of questionable use for quantitating risk

F. Since the model accounts for metabolic rate differences among species, and provides an estimate of the steady state concentration of the active metabolite (chloroethylene oxide) in the liver, do we still need a scaling factor, i.e., a metabolic rate adjustment.

Six reviewers believed that no surface area correction is required in quantitating cancer risk if the PBPK model is used. Two agreed that there should be one and the others made no comment. The reviewers that believed a surface correction should be included were concerned that the the model accounts for dosimetric considerations, but does not account for possible toxicodynamic differences among species.

*Response:* In other assessments, a body surface correction, or metabolic scaling factor, has been applied to account for the fact that laboratory animals, which are smaller than humans, have a correspondingly higher metabolic rate and thereby are predicted to detoxify a chemical faster, resulting in a smaller steady state concentration of the chemical at the target site. The PBPK model for VC was developed to predict the steady state concentration of the active metabolite at the target site. The model included metabolic rate factors. An additional surface area correction is therefore considered to be inappropriate. It should also be emphasized that scaling was not designed to account for species differences in toxicodynamics.

G. For the RfD and RfC, has the most appropriate critical effect been chosen (i.e., effect occurring at the lowest concentration).

The pathologist present on the panel recommended the use of liver cell polymorphism and bile duct cysts as the most appropriate endpoints for quantitating noncancer risk. Other panel members, with one exception agreed. These endpoints were recommended, rather than liver necrosis which was used in the draft document because they occur at lower exposure levels than liver necrosis, they are not considered to be preneoplastic and they are indicative of liver toxicity. One reviewer recommended the use of basophilic foci because they are noted at an even lower concentration than polymorphisms.

*Response to Comment:* The change to utilization of liver cell polymorphism and bile duct cysts was agreed to and appropriate changes have been made in the noncancer risk estimates. Use of basophilic foci was rejected because it was pointed out that this endpoint may be a precursor to cancer and is thus not appropriate for use in development of RfC-RfDs.

H. Were the appropriate studies used for development of the RfD and RfC.

The Til et al. (1991) study in which liver cell polymorphism was identified as the critical endpoint was also recommended for development of the RfC rather than available inhalation studies. This recommendation was made because the critical endpoint was detected at a much lower concentration than any endpoints reported in inhalation studies; pharmacokinetic data indicate that accurate route extrapolation is feasible; the Til et al. (1991) study is of higher quality than available inhalation studies, and it is of chronic duration rather than the inhalation studies. The reviewers generally felt comfortable using a route extrapolation because VC is well absorbed by both routes, the liver is the primary target organ by both exposure routes and use of the oral study to derive an RfC results in at least as conservative an assessment of risk as use of a lower quality inhalation study. One reviewer believed that the Bi et al. (1985) inhalation study is adequate for derivation of an RfC despite the fact that it is a subchronic study, and the data was unsuitable for derivation of a benchmark dose.

*Response:* The recommendation regarding the use of the Til et al study has been agreed to and appropriate changes have been made to the document. Route extrapolation results in a conservative estimate of risk since essentially all vinyl chloride taken up via the oral route will pass through the liver first. It is thus very unlikely that an equivalent inhaled dose will result in a greater liver concentration of VC. Use of the Bi et al. (1985) study was not agreed to. The study is of only subchronic duration, it is of lower quality than the Til et al. (1991) study and identified a considerably higher NOAEL. It was, however used to support the recommended RfC.

### *(3) Additional comments by Panelists*

A. Comment: One reviewer recommended combining the Til and Feron oral studies for estimating cancer potency.

*Response :* Combining the studies was not considered to be appropriate because the Til et al. study, while similar in design to the Feron study was not concurrent, and used very low doses with only a very marginal and not statistically significant response.

B. Comment. Some reviewers recommended that the high dose in the Maltoni et al. rat and mouse studies be eliminated from the data sets used to estimate cancer potency because the concentrations were well above those required for saturation of activation pathways.

*Response:* These dose groups were retained because the PBPK model was designed to account for metabolic saturation and a larger data set will decrease the uncertainty in estimating the unit risks.

C. Comment: Liver metabolism may change with time.

One reviewer was concerned that the PK model did not account for possible changes in rate of liver metabolism through the animals' lifetime. These changes could occur either due to aging

or to liver injury. Other panel members, however, did not believe that either aging or liver toxicity were likely to result in sufficient changes in liver metabolism to result in significant dosimetry errors.

*Response:* While this is of concern, data was available indicating that liver metabolism normally did not show large changes with aging and few of the doses were expected to induce a level of toxicity that would alter metabolism greatly. Nevertheless, exposure to the highest concentrations may approach maximum tolerated doses and result in altered liver metabolism.

D. Comment: A range of cancer potency estimates may be more appropriate than the recommendation of a point estimate of risk.

One of the reviewers felt that the degree of uncertainty precluded recommendation of a point estimate of cancer risk.

*Response:* The uncertainty in estimating cancer potency of VC is less than that for many chemicals evaluated by EPA in several respects. Considerable pharmacokinetic data is available in both animals and humans, allowing accurate determination of active metabolite concentrations at the target site. There is site concordance for tumors in laboratory animals and humans. Cancer potency estimates are further supported by epidemiologic data. A point estimate was therefore deemed appropriate for this assessment, and existing uncertainties are discussed.

E. Comment: Use of animal data results in an overly conservative estimate of risk

Some of the reviewers believed that development of cancer risk estimates based upon animal data overpredict risk because estimates based upon human data result in considerably lower estimates.

*Response:* It is true that the animal data predict greater risk. However, the cohorts used in the epidemiology studies were generally healthy adult males. Risk may be greater during early life exposure, among sensitive population because of genetic factors, health status, etc. Moreover, as noted previously, exposures were very uncertain in the epidemiology studies.